

The 2022 – 2036 Horizon for Nuclear Physics in Canada

From the Core of Matter to the Fuel of Stars

A report prepared by the
Canadian Institute of Nuclear Physics
for the
Canadian Subatomic Physics Long Range Planning Committee

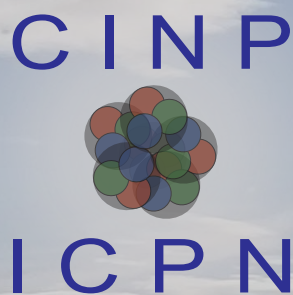

Svetlana Barkanova
Memorial University

Iris Dillmann
TRIUMF

Adam Garnsworthy
TRIUMF

Gerald Gwinner
University of Manitoba

Garth Huber
University of Regina

Juliette Mammei
University of Manitoba

December 1, 2020

This page deliberately left blank.

Contents

1	Introduction	7
1.1	Consultation process	7
1.2	The key questions in nuclear physics	8
1.2.1	How do quarks and gluons give rise to the properties of strongly interacting particles?	8
1.2.2	What are the phases of strongly interacting matter, and what roles do they play in the cosmos?	9
1.2.3	How does the structure of nuclei emerge from nuclear forces?	9
1.2.4	What is the role of radioactive nuclei in shaping the visible matter in the universe?	11
1.2.5	What physics lies beyond the Standard Model?	13
1.3	Benefits of nuclear physics research to society	15
2	Executive Summary of Recommendations	16
3	Physics Case	20
3.1	Hadronic physics and QCD	20
3.1.1	Overview	20
3.1.2	The Canadian Program	21
3.1.2.1	Hadronic physics theory program	21
3.1.2.2	Thomas Jefferson National Accelerator Facility (Jefferson Lab, JLab)	21
3.1.2.3	Mainz Microtron	27
3.1.3	The longer term: The Electron-Ion Collider (EIC)	28
3.1.3.1	Physics Program	28
3.1.3.2	Current Canadian effort	30
3.1.3.3	Long Range Planning Visions	34
3.1.4	Summary	35
3.2	The structure of nuclear matter	36
3.2.1	Overview	36
3.2.2	The Canadian program	36
3.2.2.1	Canadian effort in nuclear structure theory	36
3.2.2.2	Studies of neutron halos and skins	39
3.2.2.3	Tests of <i>ab-initio</i> theories in light- to medium-mass systems	40
3.2.2.4	Evolution of nuclear shell structure	41
3.2.2.5	Studies of nuclear collectivity, shape coexistence, and shape transitions	43

3.2.3	Experimental facilities	46
3.2.3.1	Experiments at the ISAC and ARIEL facilities of TRIUMF	46
3.2.3.2	International collaborations and Canadian-driven programs at off-shore laboratories	56
3.2.4	Beyond the next five years	57
3.2.5	Summary	59
3.3	Nuclear Astrophysics in Canada	60
3.3.1	Overview	60
3.3.2	The Canadian program	61
3.3.2.1	Summary of the program	61
3.3.2.2	Creation of nuclei in stars	64
3.3.2.3	Neutron star physics and the equation of state	68
3.3.2.4	Decays of nuclides under stellar conditions	70
3.3.2.5	Theoretical nuclear astrophysics efforts	72
3.3.3	Experimental Facilities	76
3.3.3.1	Experiments at the ISAC facilities at TRIUMF	76
3.3.3.2	Offshore experiments	82
3.3.4	Beyond the next five years	86
3.3.4.1	New setups at the ISAC facility	87
3.3.4.2	Theoretical Developments	88
3.3.5	Summary	88
3.4	Fundamental Symmetries	90
3.4.1	Overview	90
3.4.2	The Canadian program	90
3.4.2.1	Time reversal and CP violation: Permanent electric dipole moments and related searches	90
3.4.2.2	Neutral current weak interactions	95
3.4.2.3	CPT, Lorentz and weak equivalence principle violation	99
3.4.2.4	Nuclear decay	101
3.4.2.5	Beta neutrino correlations with trapped atoms and ions, and cold neutrons	103
3.4.2.6	Neutrinos	105
3.4.3	Beyond the next five years	108
3.4.4	Summary	109
3.5	Nuclear Theory	110
3.5.1	Overview	110
3.5.2	The Canadian program	110
3.5.2.1	QCD under extreme conditions	111
3.5.2.2	Lattice field theory for QCD and beyond	113
3.5.2.3	Hadron structure with LFHQCD, ChPT and QCD sum rules	114
3.5.2.4	Precision studies with electromagnetic probes	115
3.5.2.5	Nuclear many-body problem and astrophysical signatures	117
3.5.2.6	Ab-initio nuclear theory and applications	118
3.5.2.7	Nuclear Theory and Experiment – Synergy	121
3.5.3	Beyond the next five years	122
3.5.3.1	Lattice QCD and non-perturbative approaches	122

3.5.3.2	Perturbative QCD	123
3.5.3.3	Effective field theory (EFT)	123
3.5.3.4	Phenomenology and model-building	123
3.5.3.5	Nuclear structure and nuclear reactions	124
3.5.4	Summary	124
4	Opportunities Enabled by New Facilities	125
4.1	Canadian facilities	125
4.1.1	TRIUMF	125
4.1.1.1	The national and international roles of TRIUMF	125
4.1.1.2	The Isotope Separator and ACcelerator – ISAC	126
4.1.1.3	The Advanced Rare IsotopE Laboratory – ARIEL	126
4.1.1.4	Ultra-cold neutron source for fundamental physics	129
4.1.1.5	Longer-term upgrades: Storage Ring	130
4.1.2	SNOLAB	132
4.2	International facilities	133
4.2.1	Thomas Jefferson National Accelerator Facility	133
4.2.2	CERN (Antiproton Decelerator and ELENA)	133
4.2.3	Canadian involvement in the Electron-Ion Collider (EIC)	134
4.2.4	Leveraging opportunities at other facilities world-wide	136
4.2.4.1	Argonne National Laboratory (ATLAS), USA	136
4.2.4.2	Duke University Free-Electron Laser Laboratory (DFELL), USA and Mainz Microtron (MAMI), Germany	137
4.2.4.3	Facility for Antiproton and Ion Research (FAIR), Germany	137
4.2.4.4	Facility for Rare Ion Beams (FRIB), USA	137
4.2.4.5	Grand Accelérateur National d’Ions Lourds (GANIL)	137
4.2.4.6	Mainz Energy-Recovering Superconducting Accelerator (MESA), Mainz, Germany	138
4.2.4.7	Oak Ridge National Laboratory (SNS) and National Institute of Standards and Technology (NIST), USA	138
4.2.4.8	RIKEN Nishina Center (RNC), Japan	138
4.2.4.9	Texas A&M University Cyclotron Institute	138
4.3	Accelerator development for nuclear physics	140
4.3.1	ISAC/ARIEL High-power target development	140
4.3.2	ISAC accelerator development	140
4.3.3	Electron-Ion Collider related accelerator technologies	141
4.3.4	General Accelerator R&D	141
4.3.4.1	Model-based and model-coupled beam tuning	141
4.3.4.2	High intensity proton driver accelerators (medical purpose or neu- tron production)	142
4.4	The role of high performance computing	143
4.4.1	Experimental nuclear physics requirements	143
4.4.1.1	Jefferson Lab	143
4.4.1.2	TRIUMF	144
4.4.1.3	nEXO	144
4.4.2	Theoretical nuclear physics requirements	145

4.4.2.1	Ab-initio nuclear structure	145
4.4.2.2	Lattice QCD	145
4.4.2.3	Quantum Monte Carlo simulations of neutron stars and nuclei . . .	145
4.4.2.4	Relativistic quark-gluon plasma	146
4.4.2.5	Multi-loop effects in precision measurements	146
4.5	Detector development within the Canadian nuclear physics community	148
4.5.1	Future Technologies	148
4.5.2	Applications	150
4.5.3	Conclusions	150
5	The Human Element: Positive impacts on Canadian society	151
5.1	Equity, Diversity and Inclusion	153
5.2	Outreach	158
5.3	Overview of the skills acquired in nuclear physics training	161
5.4	Canadians in nuclear physics	164
5.5	Benefits to Canadians	165
5.6	Summary	166
6	Recommendations and Budgetary Estimates	168
6.1	Major recommendations	168
6.2	Budget estimates to implement recommendations	174
6.2.1	Restrained (minimum viable) scenario	174
6.2.2	The optimal scenario	175
6.2.3	Major capital investments	176
A	List of Acronyms	180

Chapter 1

Introduction

Through the aegis of the Canadian Institute of Nuclear Physics (CINP), the nuclear physics community has gathered together to outline its vision for the next 5 years and beyond. That vision is summarized in this report, prepared by a representative committee consisting of the CINP Executive Director and the Chairs of the five CINP Scientific Working Groups, “The CINP White Paper Committee”. Our duty was to gather community input and prepare a document placing the Canadian nuclear physics contributions within a long-term and international context, and make some overall recommendations. We hope that it will be of value to the Canadian Subatomic Physics Long Range Planning Committee as it works to establish the vision and goals for the whole subatomic physics community in Canada.

1.1 Consultation process

The consultation process we followed is outlined below. One of the fundamental aspects of the structure of the CINP are the Scientific Working Groups (SWG), which facilitate collaboration among researchers with common interests, and enhance the profile of specific research areas within Canada. Each SWG is headed by a Chair, who is elected by its members and appointed by the CINP Board. The SWG Chairs and the Executive Director form the CINP White Paper Committee, ensuring representation from all of the sub-disciplines of nuclear physics.

In 2019, in preparation for the Long Range Plan, the CINP Board and Executive Director undertook a review and renewal of its Scientific Working Group (SWG) leadership, including their leadership and terms of reference. One SWG Chair decided to step down after two terms of service, and the terms of the other four chairs were renewed, leading to a very experienced White Paper Committee.

Due to the COVID-19 situation, a three-day virtual Town Hall meeting was held via Zoom on June 22-24, 2020. Participants were requested to submit a draft written document on their activities, plans and HQP training two weeks before the Town Hall meeting (June 5), and all were given an opportunity to revise their written briefs afterward, reflecting the discussions at the meeting. The response to the call for input was excellent, with 33 briefs received by the final deadline.

The Town Hall meeting consisted of plenary sessions, where the SWG Chairs provided overviews of the submitted briefs, and proponents of new projects invited to give presentations outlining their

plans and opportunities for new research more thoroughly. There were also breakout sessions, where each SWG Chair led discussions on the plans and priorities in each of their sub-fields of nuclear physics. Finally, there was a plenary discussion to cover the main points to be emphasized in the CINP Report.

Following this extensive community input, the committee members meet several times by Zoom in July to discuss issues and develop a cohesive plan. Four members of committee met in person at TRIUMF August 10-11, 2020, with the remaining two connecting remotely via Zoom, to prepare the main portions of the report. After further writing, online discussion, and edits, the draft report was released to the Canadian nuclear physics community for comment on September 6. Written comments were requested by September 21, and a second draft incorporating these improvements was circulated on October 20. A second virtual town hall meeting to gather further input and consensus was held on October 26, with final comments due November 13. The report was finalized and submitted on December 1. Given this extensive process, the White Paper committee members are confident this final document reflects the consensus of the CINP community.

1.2 The key questions in nuclear physics

1.2.1 How do quarks and gluons give rise to the properties of strongly interacting particles?

We know that hadrons, strongly-interacting composite particles such as protons, neutrons and pions, are made up of quarks and gluons, but we only have partial answers on how quarks are distributed and moving inside. Quantum Chromodynamics (QCD), the theory of the strong nuclear interaction between quarks and gluons, describes two regimes – the asymptotic freedom and confinement. While the discovery of asymptotic freedom within the context of perturbative QCD was recognized by the Nobel Prize in 2004, we still do not have a complete solution in the confinement regime, where the quark coupling strength is too large to allow the use of perturbative methods. Thus, the explanation for the observed properties of the hadrons remains one of the central problems of modern physics, requiring advances in both theory and experiment. Recent advances in lattice QCD make it possible to extrapolate full lattice QCD simulations to physical quark masses, and thus allow direct comparison to experimental observables such as spectrum of hadrons. Further developments in computational methods making full use of new computing technologies and decisive breakthroughs are anticipated in the near future. In addition, the Chiral Perturbation Theory (ChPT), an effective field theory based on chiral symmetry of QCD, can provide stringent predictions of many fundamental properties of composite systems at low energies such as electromagnetic polarizabilities. Electromagnetic polarizabilities are fundamental properties of hadrons which are especially interesting because their values reflect dynamical response of hadrons to the electromagnetic probe at different energies, and their measurement provide an important test point for ChPT, dispersion relation approaches, and lattice QCD calculations.

Canadian theorists are major contributors to lattice calculations and to predictions based on ChPT and are closely working with experimentalists on planning the measurements and providing theory input, such as radiative corrections. Experiments designed to make detailed comparisons with QCD predictions are high-priority endeavours of research at facilities across the USA, Europe and Japan, with goals of obtaining: a tomographic view of the quarks and their motion within the nucleon; the elucidation of the role of gluons and gluon self-interactions in nucleons and nuclei;

and a detailed understanding of how QCD governs the transitions of quarks and gluons into pions, protons and neutrons. Hadron spectroscopy has become even more exciting since evidence for new types of groupings in heavy-quark systems have been found: tetraquark and pentaquark, candidates in the charmonium sector, and hybrids in the light-quark sector probed in pion production.

Canadians have leadership roles in a number of experiments at offshore facilities, including detailed measurements of proton, kaon and pion structure, and investigations of the spectrum of hybrid mesons containing explicit gluonic degrees of freedom. For example, a Canadian group led experimental efforts at JLab to extract the photon-beam asymmetry for η and η' , resulting in a Ph.D. thesis and a publication [The GlueX Collaboration, S. Adhikari et al., Phys. Rev. C **100**, 052201(R) (2019)]. The extracted beam asymmetry afforded comparisons to theoretical models, and indicated the dominance of natural parity exchange in the reaction mechanism.

1.2.2 What are the phases of strongly interacting matter, and what roles do they play in the cosmos?

Nuclei make up 99.9% of the visible matter in the universe. At the highest densities, yet at still rather low temperatures, the quarks making up the nucleons of nuclear matter may form a new state of matter, which is color-superconducting. Exotic nuclear matter can also be created by colliding nuclei at relativistic energies. In this case, ‘nuclear temperatures’ can reach values that represent a state of matter (the quark-gluon plasma) as it existed during the first moments after the Big Bang. This is an active field of study at international facilities such as RHIC in the USA, and the LHC at CERN. There are a number of very active Canadian theorists who are making significant contributions to our understanding of the phase diagram of nuclear matter. Their work has significant bearing on the quest to characterize the properties of the quark-gluon plasma, and for our understanding of astrophysical phenomena such as neutron star structure and the evolution of the early universe.

In recent years, the nuclear theory group at McGill University has developed and put forward a 3D, relativistic, viscous fluid-dynamical approach that has been successfully used to model the time-evolution of the high-energy nuclear collisions. A fundamental question in all studies of the many-body effects observed in high energy heavy ion collisions is whether the observed correlations develop dynamically or are already present in the initial states. A new approach has recently been constructed [Scott McDonald, Sangyong Jeon, Charles Gale. Nucl. Phys. A982 (2019) 239] which properly takes into account the the evolution in full 3-dimensional space. Importantly, the physics of the IP-Glasma relies on that of *saturation*: the scale at which the non-linearities of the gluon field manifest themselves. The exploration of the *saturation regime* is a central theme of the Electron-Ion Collider which will push our study of QCD to new frontiers.

1.2.3 How does the structure of nuclei emerge from nuclear forces?

Understanding the strong nuclear force binding the protons and neutrons to form the wide variety of complex nuclei in the universe has been a century-long challenge. Enormous progress has been made to this point, but it is a central pursuit of current nuclear structure research to reveal the fine details of the strong nuclear force that is responsible for the properties of nuclei and nuclear matter.

The rare isotopes are breaking the boundaries of our conventional knowledge and reforming our views on how nature organizes the building blocks, protons and neutrons, into a wide variety of

complex atomic nuclei. Nuclear shells form the fundamental pillars that guide the characteristics of the atomic nucleus, influence the processes of element synthesis and are imprinted in the abundance of elements in nature.

Over the past decades it has been determined that the well-established nuclear shells that were identified in stable isotopes in the 1950's, disappear in rare isotopes while new ones appear. This brings challenges to our understanding of nature's strong force that is at the heart of existence of all visible matter. Associated with the changes in nuclear shells the rare isotopes manifest unexpected forms with the creation of a thick surface, called a neutron skin, in isotopes with large neutron-to-proton ratio. This predominant neutron surface provides us with laboratory access to understand neutron-dominated objects in the universe and find new features, such as new excitation modes, that arise from it. While a few discoveries with light nuclei have opened a new paradigm, much of the rare isotopes remain unexplored. Canadians have a unique opportunity to make substantive advances in this field through utilizing the world-leading capabilities of the TRIUMF-ISAC and ARIEL facilities for rare-isotope production as well as leveraging complementary opportunities at rare-isotope laboratories world-wide.

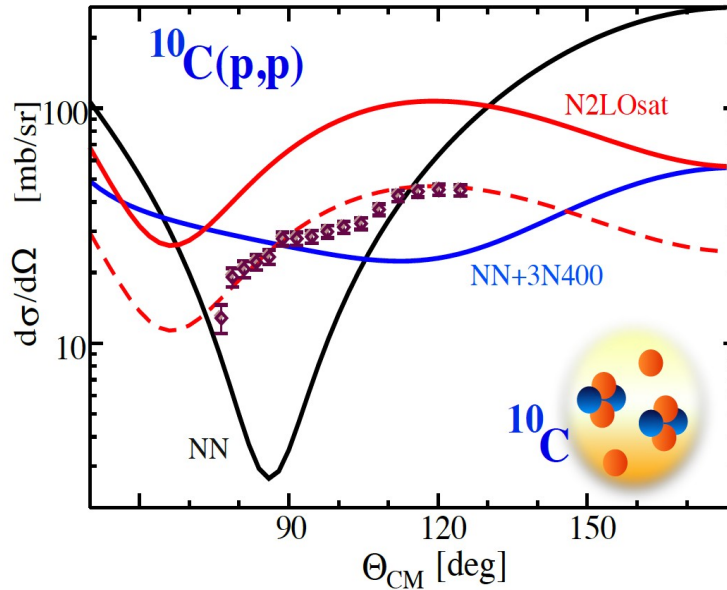

Figure 1.1: The differential cross section for $^{10}\text{C}(p,p)$ at $E_{cm} = 4.15$ MeV, adapted from [Phys. Rev. Lett. 118 262502 (2017)]. The symbols represent the experimental data. The curves represent no-core shell model with continuum calculation results with different chiral forces.

A recent highlight of the impact Canadian scientists are making is in revealing the imprints of the nuclear force in the elastic scattering of protons on ^{10}C . The chiral effective field theory enables a link for its description connected with the theory of quantum chromodynamics but requires certain parameters that are not uniquely defined. From a measurement of proton elastic scattering on ^{10}C using the IRIS facility at the TRIUMF-ISAC laboratory, and *ab-initio* nuclear reaction calculations performed by a collaboration led by the TRIUMF theory group, it was found that the shape and magnitude of the measured differential cross section is strongly sensitive to the nuclear force prescription (Fig. 1.1) ¹.

¹A. Kumar *et al.*, Phys. Rev. Lett. 118, 262502 (2017); Editors Suggestions and Viewpoint in Physics.

1.2.4 What is the role of radioactive nuclei in shaping the visible matter in the universe?

Per aspera ad astra ("Through hardships to the stars") - Lucius Annaeus Seneca, (4 BC–65 AD)

Nuclear astrophysics – connecting nuclear physics properties and the creation of nuclides in astrophysical events – has grown to a mature research field that connects many aspects of experimental and theoretical nuclear physics. The experimental tools are multifaceted, ranging from small accelerators installed at universities or even in underground laboratories to larger setups installed at radioactive beam facilities. With this variety of tools measurements of astrophysically relevant parameters are carried out.

The by far most important event for the nuclear astrophysics community in the last 5 years was the detection of the gravitational wave signal GW170817 from a binary neutron star merger, followed about 1.7 s later by a short γ -ray burst (GRB170817A). This triggered a world-wide unique effort that coined the term "multi-messenger astronomy", and about 11 h later the astronomical transient (AT2017gfo), a "kilonova", was under close observation by dozens of telescopes in various wavelengths from radio to X-rays² (see Fig. 1.2). Not surprisingly, the Nobel Prize in Physics 2017 went to the three key players of the LIGO/Virgo collaboration, Rainer Weiss, Barry C. Barish, and Kip S. Thorne "for decisive contributions to the LIGO detector and the observation of gravitational waves".

The event that triggered the gravitational wave emission on August 17th 2017 was identified as a merger of two neutron stars, a scenario that has never been observed before and is connected to the creation of about half of the elements heavier than iron in the so-called "rapid neutron capture (r) process". This astrophysical process is deeply connected to the nuclear physics of short-lived neutron-rich nuclei and the Equation of State (EoS) of neutron star matter, and was the prime motivation for the construction of the new generation of radioactive beam facilities worldwide, including the ARIEL facility at TRIUMF in Canada (see Sec. 4.1.1.3), as well as FRIB in the USA and FAIR in Germany³ (see Sec. 4.2.4).

A very successful "multi-messenger nuclear (astro)physics" program is already being carried out at many facilities and universities, with the aim to better understand various aspects of the creation of nuclei in stellar events. The detection of GW170817 and all follow-up observations have now laid a firm foundation for a new highway to the interior of stars on which the Canadian Nuclear Astrophysics community is already moving since many years. The main focus of the experimental program will be the science enabled by the phased commissioning of the ARIEL facility, complemented by offshore experiments at radioactive beam facilities.

The experimental tools for the measurement of important nuclear properties of the nuclei, like reaction cross sections, decay half-lives, nuclear masses, and particle emission probabilities, have been developed and are waiting to be leveraged at this new generation of facilities. With ARIEL, the increase of available radioactive ion beamtime will not only allow the development of more beam species and more intense radioactive beams but also enable longer beamtimes to access more exotic nuclei and/or smaller cross sections which will greatly benefit the nuclear astrophysics program.

Reaction cross section measurements have been limited so far to nuclei close to stability. This limitation will be overcome in the next decade and open a new avenue for nuclear astrophysics. Specifically the indirect determination of neutron-induced cross sections of radioactive nuclei via surrogate methods like (d, p) reactions is an important extension to the ongoing efforts to measure

²B.P. Abbott et al., *Astrophys. J. Letters* 848, L12 (2017)

³C.J. Horowitz et al., *J. Phys. G: Nucl. Part. Physics* 46, 083001 (2019)

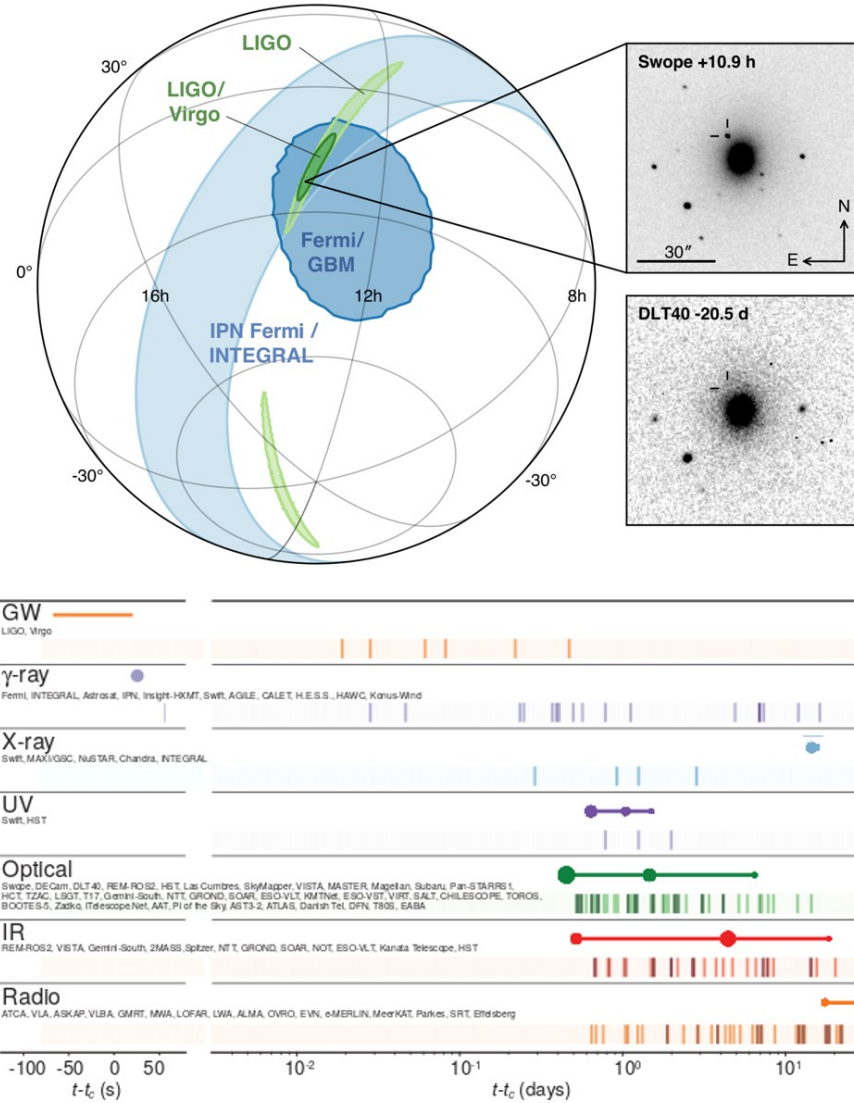

Figure 1.2: (Top) Binary neutron star merger event on August 17, 2017: Localization of the gravitational-wave, gamma-ray, and optical signals. The top left panel shows a projection of the 90% credible regions from LIGO (light green), LIGO-Virgo (dark green), triangulation from the time delay between Fermi and INTEGRAL (light blue), and Fermi GBM (dark blue). The inset shows the location of the apparent host galaxy NGC 4993 in the Swope optical discovery image at 10.9 hours after the merger and the DLT40 pre-discovery image from 20.5 days prior to merger. (Bottom) The timeline for the discovery of GW170817, GRB170817A, AT2017gfo and the follow-up observations. Source: [LIGO Webpage](https://www.ligo.org/).

proton- and α -induced cross sections at the DRAGON and EMMA recoil separator facilities, as well as with the smaller TUDA particle detector at TRIUMF.

The direct measurement of neutron-induced cross sections of short-lived nuclei might be still a bit down the road but first considerations for the world-wide unique coupling of a storage ring facility including an internal neutron generator target with radioactive beams from the ISAC facility are underway, and TRIUMF and the Canadian Nuclear Astrophysics community will play a pivotal

role in this program in the next decade(s) (see Sec. 4.1.1.5).

This experimental progress goes hand in hand with the tremendous progress on the nuclear theory side (see Sec. 3.2.2.1). *Ab-initio*, no-core shell model (NCSM), and valence space in-medium similarity renormalization group (VS-IMSRG) models for heavier nuclei have made a major step forward in the past years. Especially the VS-IMSRG model is a very promising tool since it extended the reach of *ab-initio* nuclear structure calculations to medium-mass nuclei, and in future will be able to go to heavier masses up to even the superheavy nuclei.

This decade will be the start of a new era of radioactive beam facilities that will help us push our understanding of the creation of the lightest up to the heaviest elements further than anytime before.

1.2.5 What physics lies beyond the Standard Model?

The Standard Model (SM) of Particle Physics is now half a century old, and in every way has been spectacularly successful. Its predictions have been confirmed over and over, as generations of increasingly sophisticated experiments in particle, nuclear, and atomic physics have pushed down the limits for possible deviations. At the “energy frontier” of this endeavour, collider physics has not observed any new particles beyond the Higgs, which gave closure to the SM. Neither have we found signatures of physics beyond the SM with rare meson decays or permanent electric dipole moments in atoms, to just name two methods with exquisite reach. Yet, there are extraordinarily compelling reasons to believe that the SM should not be the final answer: It does not explain dark matter nor dark energy, it gives no satisfying explanation for the extreme matter-antimatter asymmetry that we observe in our universe, and it has withstood all efforts to integrate a quantum theory of gravity, so far. In addition, aspects of the SM, while reproducing observations correctly, seem contrived, indicating that we lack deeper understanding. Why are the masses what they are? Why 3 generations of quarks and leptons? Why is only the weak interaction violating parity, why is this violation maximal, and CP violation seems unnaturally small? In addition, we only start to unravel the details of the neutrino sector. Clearly, we must press on to find answers to these fundamental questions.

Nuclear physics, and closely associated experiments in atomic and molecular (AMO) physics, at the low-energy, precision, frontier, have played an important role all along in trying to answer these questions, complementary to high energy techniques. Advantages of this community are the diversity of efforts, nimble response to the changing landscape, relatively modest budgets, and diverse HQP training. Increasingly, a connection is forming to the emerging field of “quantum sensing”, or more broadly “quantum technology”, promising major gains in experimental sensitivity. Canada plays a distinguished role in the domain, with numerous efforts at two world-class domestic facilities, TRIUMF, and SNOLAB, as well as abroad, for example at JLab and CERN, covering most aspects of searches for physics beyond the SM. In the following we present some recent successes with Canadian involvement (more details are discussed in Sec. 3.4).

The Qweak collaboration published its final result ⁴ for the weak charge of the proton, 0.0719 ± 0.0045 , derived from the parity-violating asymmetry in the scattering of polarized electrons on protons, measured at the 9 ppb level (see Fig. 1.3). The result is in excellent agreement with the SM prediction, and sets multi-TeV-scale constraints on any semi-leptonic parity-violating physics not described within the SM. The tour-de-force *nPDGamma* effort concluded by reporting the first

⁴D. Androić *et al.*, *Nature* 557, 207 (2018).

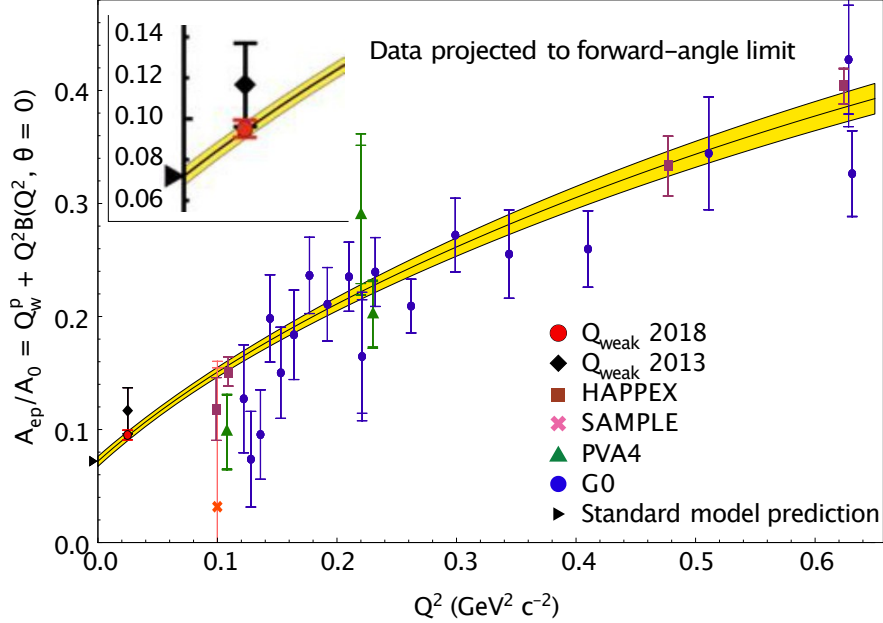

Figure 1.3: Determination of the proton’s weak charge by extrapolation of the reduced asymmetry to zero momentum transfer. The accuracy is dominated by the Q_{weak} result (taken from [D. Androić et al., Nature 557, 207 \(2018\)](#)).

non-zero measurement of parity violation in the neutron-proton system ⁵, and the $n^3\text{He}$ collaboration accomplished the same feat in the neutron- ^3He system ⁶. The ALPHA anti-hydrogen effort produced a series of outstanding measurements. Amongst them, charge-neutrality of \bar{H} was confirmed at the 10^{-9} level, the $1s - 2s$ transition frequency was measured to 10^{-12} , and laser cooling was demonstrated ⁷. The EXO-200 collaboration put a lower limit for the $0\nu\beta\beta$ lifetime of ^{136}Xe of 3.5×10^{25} years ⁸, which is one of the most competitive measurements. EXO-200 was the first 100-kg class $0\nu\beta\beta$ detector and was decommissioned in 2018 after almost a decade of operation. The TRINAT atom trap facility at TRIUMF reported the best relative accuracy of any β asymmetry in a nucleus, with a 0.3 % measurement on laser-trapped and nuclear spin polarized sample of ^{37}K ⁹. The superallowed β decay team, amongst numerous improved branching ratios and lifetimes, carried out the first superallowed half-life measurement to better than 10^{-4} , using ^{10}C ¹⁰. Teams involving theorists from Alberta ¹¹ and Manitoba ¹² refined calculations of radiative corrections in beta decay, opening up a 2 to 3 σ tension in CKM unitarity. The TUCAN collaboration reported the first production of ultra-cold neutrons at TRIUMF in 2017 ¹³, and is on their way to start their neutron EDM experiment by 2023. The team built and commissioned a new fast kicker magnet ¹⁴

⁵D. Blyth *et al.*, *Phys. Rev. Lett.* 121, 242002 (2018).

⁶M. Gericke *et al.*, *Phys. Rev. Lett.* 125, 131803 (2020).

⁷M. Ahmadi *et al.*, *Nature* 529, 373 (2016); M. Ahmadi *et al.*, *Nature* 557, 71 (2018).

⁸G. Anton *et al.*, *Phys. Rev. Lett.* 123, 161802 (2019).

⁹B. Fenker *et al.*, *Phys. Rev. Lett.* 120, 062502 (2018).

¹⁰M.R. Dunlop *et al.*, *Phys. Rev. Lett.* 116, 172501 (2016).

¹¹A. Czarnecki *et al.*, *Phys. Rev. D* 100, 073008 (2019).

¹²K. Shiells, Ph.D. thesis, University of Manitoba, 2020.

¹³S. Ahmed *et al.*, *Phys. Rev. C* 99, 025503 (2019).

¹⁴S. Ahmed *et al.*, *Phys. Rev. Accel. Beams* 22, 102401 (2019).

servicing a new proton beamline with a high-power spallation target. The FrPNC experiment at TRIUMF detected in 2018 for the first time the Stark-induced $7s - 8s$ transition in laser-trapped, atomic francium, preparing the ground for a parity violation experiment.

In the sections following the Executive Summary, we will discuss the contributions of Canadians to these questions in greater detail, placing this work in the broader context of the field as a whole, and giving an indication of where this work is expected to lead in the next 5 years and beyond.

1.3 Benefits of nuclear physics research to society

Canadian nuclear physicists are at the forefront of their fields - studies by the Council of Canadian Academies and Science Metrix both found that Canada is a “world-leader” in subatomic physics and astrophysics ¹⁵. Nuclear technology has an impact in a variety of scientific fields; only computers, microelectronics, and possibly laser technology surpass nuclear physics techniques as the most widely used set of tools in science. For example, nuclear techniques are the gold standard for measuring the age of ancient objects, from the archaeological to the cosmic time scales. Nuclear-tracer techniques are used to unravel bio-chemical pathways, to determine the efficiency of chemical reaction vessels, and to measure the flow of ground water. Another example is that of the GlueX experiment, at JLab. That collaboration’s requirement for stringent silicon photomultiplier (SiPM) specifications has produced tile arrays that are now used in medical imaging. Most, if not all, of these technologies were not developed for the specific application for which they are used, but came about as a result of the pursuit of fundamental nuclear physics research.

An example of the importance of having a large base of knowledgeable and skilled researchers is evident in the recent success of an interdisciplinary team of researchers including Canadian nuclear physicists. This team set out five years ago to develop a reliable, alternative means of producing a key medical isotope, $^{99}\text{Tc}^m$. The project resulted in over a dozen scientific publications, several provisional patents, and a training opportunity for more than 175 individuals. The team demonstrated true collaboration in solving this worldwide healthcare challenge and received the NSERC Brockhouse Canada Prize for Interdisciplinary Research in Science and Engineering for this groundbreaking, and life-saving, technique. ¹⁶ This achievement is a direct result of investment provided by the Government of Canada through programs at the Natural Sciences and Engineering Research Council, the Canadian Institutes of Health Research, and Natural Resources Canada.

¹⁵ “The State of Science and Technology in Canada, 2012.” The Expert Panel on the State of Science and Technology in Canada, Council of Canadian Academies

¹⁶ NSERC Brockhouse Canada Prize for Interdisciplinary Research in Science and Engineering 2015

Chapter 2

Executive Summary of Recommendations

The Canadian nuclear physics community is pursuing a diverse set of research endeavors which address key questions identified by broad international consensus as being of major importance in understanding the origin, evolution and structure of visible matter in the universe. These endeavors are carried out both at TRIUMF in Canada and at international facilities where researchers lead exciting, unique opportunities that are not available onshore. Our specific recommendations for maximizing Canadian scientific output in nuclear physics research are detailed in Chapter 6, and are listed here in shorter form for convenience.

1. Enhance nuclear theory support

The advancement of nuclear physics is strongly dependent on the interplay between theory and experiment. Theory input is indispensable for many experimental programs, including the quickly-developing precision frontier which can reach for new physics at TeV scale. For example, nuclear corrections are still the largest systematic uncertainty in neutrino oscillation data. In addition to predictive first-principles (*ab-initio*) and phenomenological modeling, theorists identify promising future directions for the experimental programs, participate in experimental proposals, develop new computational methodology, help to interpret the experimental data, and educate the future generation of researchers in both theory and experiment. The key to successful collaboration between theory and experiment in such areas is close coordination and rapid theory response to the needs of experimental programs. At the same time, excellence in theory depends on diversity of ideas and people, and it is essential to support a wide range of theoretical programs in all regions of Canada.

We recommend an increased support for nuclear theory researchers at a level that is sufficient for faculty members to allow travel and also to support postdocs and graduate students. Budgetary estimates are in Sec. 6.2.2.

2. Maintain a diverse program of excellence in experimental and theoretical nuclear physics research.

The Canadian nuclear physics program is grouped around several key questions that are each internationally recognized as being of high priority. Recognizing the need to maintain scientific

excellence and a critical mass of effort, the Canadian nuclear physics research community has self-selected where to concentrate its effort, taking leadership roles or making significant contributions in initiatives addressing these questions both onshore and offshore. There are many inter-connections between the key nuclear physics questions, and advances in one area often follow from progress in a complementary area.

Canadian participation and leadership in scientific experiments and developments at offshore rare isotope facilities should continue to be supported. Canadian researchers have successful scientific programs and are building detectors for various RIB facilities, including the new major in-flight facilities at NSCL/FRIB in the USA and GSI/FAIR in Germany.

We strongly recommend that a diverse nuclear physics program addressing all of the key questions be maintained in all funding scenarios.

3. Fund the additional HQP needed to capitalize on new or recently-upgraded facilities

Substantive progress towards the resolution of the key questions in nuclear physics requires highly qualified personnel (HQP), including undergraduate and graduate students, post-doctoral fellows (PDFs) and technical staff. Furthermore, recent strategic investments are enabling the development of major new experimental facilities addressing these key questions, such as:

- At ISAC, CANREB beams are coming online, and new detectors have or are nearing completion such as: the Electromagnetic Mass Analyser (EMMA, ramping up after first experiments in 2019), and the proposed Radioactive Molecules for Fundamental Physics (RAMS) facility.
- The upgraded TRIUMF Ultra Cold Neutron EDM experiment is projected to be assembled in 2023, with experiments planned for the following two to three years.
- The DOE recently approved Critical Decision 0 (Mission Need) for a tonne-scale $0\nu\beta\beta$ experiment, for which nEXO at SNOLAB is a strong candidate. This would be a major opportunity for future Canadian leadership.
- The Jefferson Lab 12 GeV upgrade is now complete, and Canadians are finally starting to see the fruits of their work in terms of high quality new data.
- The ALPHA-Canada Collaboration will be capitalizing on the new infrastructures ALPHA-g and ALPHA-3 at CERN, as well as HAICU in Canada.

The experimental studies enabled by these new facilities have very high scientific merit and Canadians are well-placed to take advantage of these opportunities. These facilities also provide an excellent training ground for the subatomic physics HQP who generate the innovative ideas used to design, build, and operate experiments and facilities, devise improved algorithms to analyze collected data, and create the numerical simulations to interface theoretical models with measurement data. After graduation, the wide range of highly-valuable skills they gain from training in nuclear physics allows them to contribute towards the Canadian innovation economy in multiple areas related to science and technology.

Without sufficient operating funds, to support the HQP for data taking, analysis and dissemination of results, the Canadian leadership and impact in experiments such as these will be lost. *It is essential that a corresponding increase be made in the NSERC Subatomic Physics envelope to support the research teams that will drive the scientific output from these new facilities.* Budgetary estimates are in Sec. 6.2.2.

4. Leverage the scientific opportunities enabled by the completion of ARIEL

The Advanced Rare IsotopE Laboratory (ARIEL) is TRIUMF's flagship project, conceived to ensure Canada's leadership role in rare isotope science. During the period covered by the forthcoming Long Range Plan, ARIEL will move from construction to delivering science in a phased approach that will see a significant increase in the quality and variety of available radioactive beams, and a tripling of the user beam time by 2031. This will allow a large number of high priority measurements to more quickly move ahead.

To fully leverage these opportunities, Government of Canada support for TRIUMF to allow for *operational support necessary to fully exploit the science opportunities of ARIEL (9000 hours of RIB per year) is essential*. Strategic investments by NSERC in the additional HQP needed to run the experiments, analyze the data, and disseminate the results in a timely fashion is also critical to maximize the scientific output.

5. Position Canada for leadership in future international nuclear physics research

The Canadian nuclear physics program is grouped around several key questions that are internationally recognized as being of high priority. To advance our understanding of these key questions, it is understood that Canadians must be leading participants in the development of major international projects. These potential future flagship endeavors must receive the support needed to position Canada for key leadership roles.

Significant international nuclear physics projects with significant Canadian leadership contributions include Qweak and GlueX at Jefferson Lab and ALPHA at CERN. The Electron-Ion Collider (EIC) is a major international facility on the future horizon, which will uniquely address profound questions about nucleons (neutrons and protons) and how they are assembled to form the nuclei of atoms. Canadians have been involved in the planning of the EIC program for some time, and a Canadian was recently elected as International Representative on the EIC User's Group Steering Committee. *A substantial involvement in the EIC project will confirm Canada's leadership role in scientific research and development.*

6. Grow the nuclear physics research community

The 15 years of the coming long range plan constitute a very substantial fraction of the career of most researchers. Over this plan, therefore, there will be a large renewal of the senior researcher ranks of our field. Substantial scientific opportunities in both theory and experiment, such as ARIEL and EIC listed above, but also at new international radioactive beam facilities like FRIB and FAIR, make the case for an expansion of investment in nuclear physics research at universities across Canada.

Historically, Bridge Faculty Positions have proven to be an effective way to strategically grow research capacity in highly promising fields within Canadian universities. Successful nuclear physics faculty bridge programs both in Canada and abroad include: TRIUMF, RIKEN-BNL Research Center (open to Canadian institutions), FRIB Theory Alliance, and Jefferson Lab. We encourage our community to seek innovative sources of funds for such positions, so that the substantial scientific opportunities we see in the next 15 years can be best taken advantage of. We also support TRIUMF in seeking the funds to strengthen its bridge faculty program for the future.

7. Foster a funding environment which enables Canadian researchers to lead in science and discovery

Canadian researchers are at the forefront of subatomic physics research. To maintain this high level of performance in the years to come, it is essential for the range of funding opportunities and resources already in place to be strengthened and expanded.

- (a) Sufficient and versatile funding opportunities for both capital equipment and operational funding are essential to position Canadian researchers to react quickly to new research opportunities as they arise, but also the stability for planning with the long-term perspective necessary for major initiatives. *It is essential to restore the flexibility of the SAP envelope, so that RTI-1 projects at the \sim \$200k scale can be funded with a reasonable success rate. We see this as a strong rationale for an infusion of new funds to the envelope.* The interplay between NSERC, CFI and the new computing agency (see Section 4.4) also needs to be strengthened, so that capital, operating fund and high performance computing resource decisions are coordinated and streamlined.

Table 6.2 lists the major experimental initiatives that will require significant capital funding if the promised substantial improvements over current knowledge are to be realized. The largest projects on the planning \sim 2025–2030 horizon include:

- nEXO at SNOLAB.
- ISAC ion storage ring with a neutron generator target.
- Radioactive Molecules (RAMS) for fundamental physics facility at ISAC/ARIEL.
- Canadian contributions to detectors at the Electron-Ion Collider.

Opportunities may also arise at the next-generation in-flight facilities FRIB (USA) and FAIR (Germany) which will provide first beams during the period covered by this long range plan.

- (b) NSERC and TRIUMF should continue to provide technical resources and capabilities for supporting the construction of experiments, through their MRS program and the TRIUMF Science & Technology department. Whenever possible, TRIUMF should attempt to provide access to technical personnel at subsidized cost.
- (c) Ongoing investments in detector and accelerator R&D are needed to assure the continued excellence of Canadian nuclear physics research in the coming decades, and to continue the positive impacts that fundamental research has had on Canadian society and industry. Such funds are particularly needed as a seed for future projects and to explore improved technologies, including machine learning algorithm, quantum sensing and information technologies.

Chapter 3

Physics Case

In the following chapter several projects and setups with Canadian involvement and their physics cases are described. The chosen format to show the involvement of Canadian universities and research centers and international partners is “**Project** (Location) alphabetical order of Canadian partners; involved international countries”. It should be noted that due to the strong involvement of the local groups in a project, e.g. for setups at TRIUMF, the facility is not repeated in the list of Canadian universities and research centers, e.g. “**Detector X** (TRIUMF) Guelph, SFU, UBC; UK, USA”.

3.1 Hadronic physics and QCD

3.1.1 Overview

The building blocks of the atomic nucleus—the protons, neutrons, and other particles (mesons) that bind them—are collectively known as hadrons. These consist of yet more fundamental constituents, the quarks and gluons, but because the quark-gluon interaction is very strong at long distances, the fundamental constituents are confined within hadrons. The nature of the strong force at long distances, where quark confinement dominates, is one of the *major unsolved problems of modern physics*. In fact, the Fields Institute and the Clay Institute have both listed the solution of how colour confinement permits only bound states of massless gluons, forming only massive hadrons (i.e. mass gap within Yang-Mills quantum theory) as one of their Millenium Prize problems.

On the theoretical side, Quantum Chromo-Dynamics (QCD) is a framework that accurately describes quark-gluon interactions at extremely high energies (when quarks are close together), but what is poorly understood is how QCD gives rise to properties such as the mass and spin of hadrons. A taxing complication is that in the confinement regime, the quark-gluon interaction is too strong for perturbative methods to be reliably applied, and so far QCD can only be used as a basis for either model development or numerical solutions such as Lattice QCD, both of which must be guided by experimental data.

Key hadron properties and their spectrum are best studied via electron scattering and photo-production experiments, such as at Jefferson Lab (JLab, USA) and the Mainz Microtron (MAMI, Germany) that employ continuous wave electron beams. Experimental studies using inclusive electron scattering at high momentum and energy transfer have provided important information on the elementary interactions of quarks and gluons; however, our understanding is fragmented and

further experimental work is needed. Canadian research has advanced and continues to advance the understanding of the structure and properties of hadrons.

3.1.2 The Canadian Program

3.1.2.1 Hadronic physics theory program

Combining a range of approaches, such as Lattice QCD, Light Front Holographic (LFHQCD), studies of exotic hadrons using QCD sum rules, and Chiral Perturbation Theory (ChPT), the Canadian theory community is working on both advancing the field and supporting experimental efforts in Canada and off-shore (Section 3.5).

3.1.2.2 Thomas Jefferson National Accelerator Facility (Jefferson Lab, JLab)

The bulk of the Canadian involvement in experiments on hadronic physics and QCD is currently carried out at Jefferson Lab, in Newport News, Virginia, USA. The Canadian-led experiments at JLab have acquired and continue to acquire high quality data intended to better our understanding of QCD in the strongly interacting, non-perturbative regime, where quark (colour) confinement dominates.

The JLab 12-GeV Upgrade, enabling a doubling of the available electron beam energy and the construction of a suite of new detectors, was completed in 2017. Canadians are now in the “exploitation phase” of the new facility. The experiments are in data-taking and/or analysis phases, with detector R&D having been completed and detectors developed by the team installed and operating in both Hall C and Hall D.

- In the medium-term (2022–26), Canadians will be significantly involved in data-taking and leading experimental efforts in the analysis and publication of data, resulting in the publication of Canadian-led publications. The JLab Eta Factory (JEF) experiment is planned with an upgraded GlueX Experiment in Hall D, and simulations, R&D and detector construction will take place at JLab with Regina participation.
- In the longer-term (2027–36), the SoLID experiment will come online. SoLID will use the latest detector and readout technology to enable an increase in luminosity by a factor of 10 compared to existing detectors. SoLID is in an advanced stage of project planning, with Canadians contributing to Cherenkov detector R&D and construction. SoLID will see continuing activity through the end of the new LRP (2036), in parallel with the MOLLER experiment (covered elsewhere in this document).

Current Program

GlueX Experiment, GlueX (JLab) Regina; Armenia, Chile, China, Germany, Greece, Russia, UK, USA

Quantum Chromodynamics permits a “zoo” of particles. Traditionally, the manifestation of hadrons in nature has their spectrum dominated by colourless “quark model” states—such as quark-antiquark pairs (mesons) and quark triplets (baryons)—while gluonic degrees of freedom are difficult to observe or suppressed. The key question is to understand how the quark and gluonic

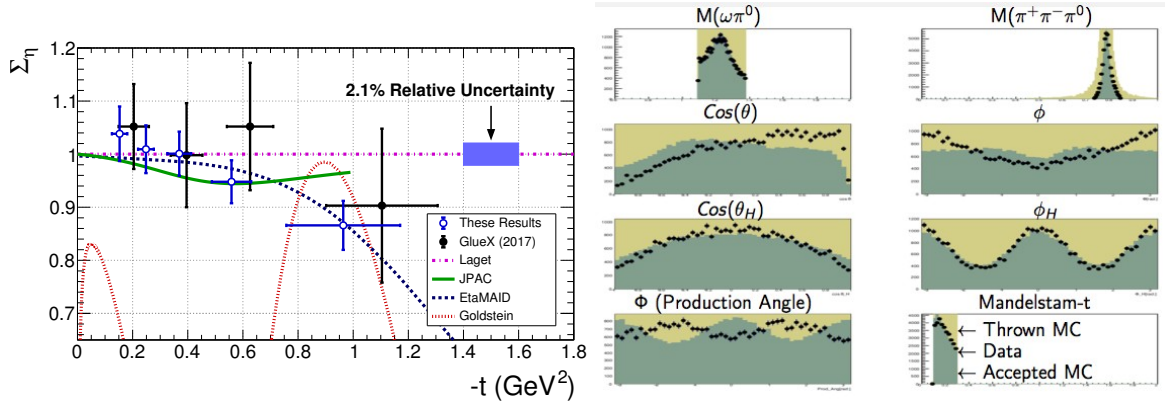

Figure 3.1: a) The photon beam asymmetry Σ_η shown as a function of Mandelstam $-t$ for $\gamma p \rightarrow p\eta$. Previous GlueX (2017) results H. Al Ghoul et al. (GlueX), Phys. Rev. C 95, 042201(R) (2017) are shown along with predictions from several Regge theory calculations: J. M. Laget, Phys. Rev. C 72, 022202(R) (2005), Phys. Lett. B 695, 199 (2011); J. Nys et al. (JPAC), Phys. Rev. D 95, 034014 (2017); EtaMAID: V. L. Kashevarov, M. Ostrick, and L. Tiator, Phys. Rev. C 96, 035207 (2017); G. R. Goldstein and J. F. Owens, Phys. Rev. D 7, 865 (1973). b) Initial PWA showing the $\omega\pi^0$ and 3π invariant masses and four angles in the helicity frame of the $\omega\pi^0$, using a JPAC amplitude analysis model A. Szczepaniak et al. (JPAC Collaboration), private communication, and indicating the dominance of $J^P = 1^+ b_1(1235)$.

degrees of freedom that are present in the fundamental QCD Lagrangian manifest themselves in the spectrum of hadrons.

Mesons are grouped in *multiplets*, each characterized by a given J^{PC} combination. Hybrid mesons result from the addition of angular momentum quantum numbers from a gluonic component to those of the two quarks and are visualized as $q\bar{q}g$ states. Among the hybrids, a subset is predicted to have exotic J^{PC} combinations that are not allowed in the simple quark model. Our understanding is maturing thanks to results from Lattice QCD calculations that predict a clear and detailed spectrum of hybrid mesons. On the experimental side, hadron spectroscopy has become more exciting since evidence for new types of groupings in heavy-quark systems has been found: tetraquark and pentaquark, candidates in the charmonium sector, and hybrids in the light-quark sector probed in pion production.

GlueX’s place in the global spectroscopy program is pivotal; the statistics from the GlueX experiment significantly exceed past data sets and provide data in unexplored domains of meson and baryon spectroscopy. More generally, the study of the light-quark hadron spectrum is the centrepiece of experimental hadron spectroscopy effort in the U.S, as articulated in the 2015 NSAC Long Range Plan: “GlueX at JLab, one of the flagship experiments of the 12-GeV Upgrade, is designed to search for exotic particles where the *glue* is in an energetically excited state.” Hadron spectroscopy ties in with the 2017–2021 Canadian Subatomic Physics LRP under section 5, “How do Quarks and Gluons Give Rise to the Hadronic Properties and the Phases of Hadronic Matter?”

The GlueX-I program commenced in 2016 and has been completed, while GlueX-II (higher luminosity) is under way and will continue over the next few years. The Regina-GlueX is charged with gain calibrations of the silicon photomultipliers (SiPMs) for the Barrel Calorimeter (BCAL), a 30-ton detector designed and built at Regina with a combination of NSERC and US-DOE funds, as well as online and offline monitoring of the SiPM stability and saturation using an LED system. Since 2019, they have started machine learning efforts to improve the understanding of the BCAL’s

electromagnetic and hadronic response. The group led efforts to extract the photon-beam asymmetry for η and η' , resulting in a 2019 Ph.D. Thesis (T. Beattie, 2019, UofR President’s Distinguished Medal) and a publication ¹. The extracted beam asymmetry afforded comparisons to theoretical models, and indicated the dominance of natural parity exchange in the reaction mechanism. An analysis of beam asymmetry in the $\eta\Delta^+$ channel is being carried out in a similar fashion to the recently completed analysis in the $\pi^-\Delta^{++}$ channel. In addition, work is ongoing in the extraction of cross section, moments and first pass at a Partial Wave Analysis (PWA) of the $b_1(1235)$ meson in its dominant $\omega\pi$ decay, on the road to looking at hybrid decays into $b_1\pi$; the initial foray shows the need to include both S- and D-waves at a ratio close to what is predicted by theory ². Three Regina Ph.D. students and a postdoc are working on these analyses.

In addition, Hornidge has recently initiated the process of joining the GlueX Collaboration in order to participate in measurements of the neutral and charged pion polarizabilities, which dovetails nicely with the MAMI polarizability program.

Pion and Kaon Form Factors as probe of emergent mass generation in hadrons (JLab) Regina; Armenia, USA

The elastic electromagnetic form factors of the charged pion and kaon, $F_\pi(Q^2)$ and $F_K(Q^2)$, are a rich source of insights into basic features of hadron structure, such as the roles played by confinement and Dynamical Chiral Symmetry Breaking (DCSB) in fixing the hadron’s size, determining its mass, and defining the transition from the strong- to perturbative-QCD domains. The pion’s properties in particular are intimately connected with DCSB, which explains the origin of more than 98% of the mass of the visible matter in the universe. Furthermore, owing to the intimate connection between DCSB and the pion, the properties of nature’s lightest hadron provide the most direct access to QCD’s momentum-dependent effective quark mass. The measurement of the pion electric form factor (F_π), which encodes our knowledge of the distribution of quarks and gluons within it, presents an extraordinary opportunity to observe QCD’s transition from confinement-dominated physics at large length-scales to short-distance scales where the aspects of perturbative QCD become apparent.

The Regina group also leads the pion form factor program at Jefferson Lab. Their to date work has had significant impact, gathering over 1000 citations, and appearing in various review articles. The work has confirmed that at a photon virtuality of $Q^2 = 2.45 \text{ GeV}^2$, one is still far from the resolution region where the pion behaves like a simple $q\bar{q}$ pair, i.e. far from the “asymptotic” limit. The measured pion form factor is a factor of about three larger than the hard (perturbative) QCD prediction. Modern calculations show that this factor could be explained by using a pion valence quark distribution amplitude evaluated at a scale appropriate to the experiment. An extended calculation indicates that above $Q^2 > 8 \text{ GeV}^2$, the pion form factor should exhibit Q^2 -dependence from hard QCD, but with normalization fixed by a pion wave function dominated by DCSB effects. The JLab experimental data allow these (and other) calculations to be tested with authority. The extension of these studies to shorter distance scales is underway. Data taking is scheduled for 2021–24, followed by 3–5 years of analysis. This work is expected to yield high quality F_π data up to $Q^2 = 6.0 \text{ GeV}^2$, and lower quality data up to $Q^2 = 8.5 \text{ GeV}^2$, and will provide the world’s best data set on this fundamental quantity until these studies can be extended at the EIC.

The K^+ form factor, where the d anti-quark is replaced with the s anti-quark, provides a vital second study case. The K^+ structure has significant influence from DCSB, as does the π^+ , but

¹The GlueX Collaboration, S. Adhikari et al., Phys. Rev. C 100, 052201(R) (2019)

²Hadron Spectrum Collaboration A. J. Woss et al., Phys. Rev. D 100, 054506 (2019)

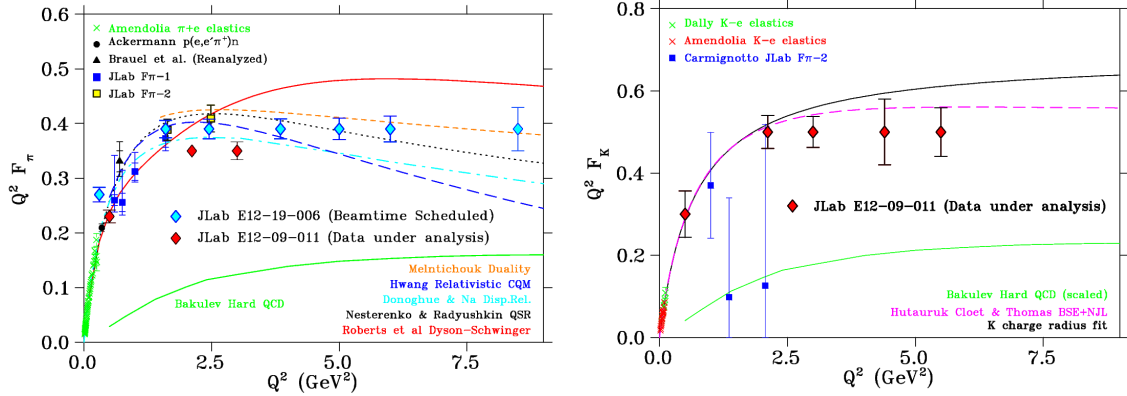

Figure 3.2: Existing data (green, black, red, blue, yellow) and projected uncertainties for data expected by 2026 from JLab Hall C for the charged pion form factor (left) and charged kaon form factor (right), in comparison to model calculations. In both cases, the planned data will be a dramatic improvement in the world database of these fundamental hadron structure observables.

the greater mass of the \bar{s} also has influence from the Higgs mechanism. The understanding of the structure of both mesons, within a unified theoretical framework, will greatly assist with our understanding of the origin of hadronic mass. The data taking for the first F_K experiment was completed in spring 2019, and results are anticipated to be published over the period 2022–25. If the data confirm that the scattering from the virtual K^+ in the nucleon dominates at low four-momentum transfer to the target $|t| \ll m_p^2$, similar to as was done for the pion, the experiment will yield the world’s first quality data for F_K above $Q^2 > 0.2 \text{ GeV}^2$.

New Projects

JLab Eta Factory, JEF (JLab) Regina; Armenia, Chile, China, Germany, Greece, Russia, UK, USA

JEF involves a significant upgrade of the GlueX base instrumentation, by replacing the inner section of the GlueX forward calorimeter (FCAL), and is planned to come online in 2024. This will allow experiments to explore both fundamental topics with experimental sensitivities not previously achievable. This device will provide enhanced performance over the base FCAL (a factor of two improvement in energy and position resolution, a factor of four enlargement in granularity, and one order of magnitude enhancement in radiation resistance). These features will enhance the GlueX exotic hybrid meson search with better particle identification and up to 60% improvement in the sensitivity of PWA and will also allow precision measurements of rare meson decays that will: (1) enable the JEF experiment to measure various η/η' decays with emphasis on rare neutral modes; (2) provide the radiation resistance needed by GlueX to run at high luminosity for exotic hybrid meson search with better particle identification and up to 60% improvement in the sensitivity of PWA.

JEF will probe the role of scalar meson dynamics in chiral perturbation theory for the first time, tighten the uncertainty in the light quark mass ratio extracted from $\eta \rightarrow 3\pi$, search for sub-GeV dark gauge bosons (a leptophobic vector B' and an electrophobic scalar φ') by improving the existing bounds more than two orders of magnitude that is complementary to the ongoing worldwide efforts on invisible decays or decays involving leptons; and provide direct probes for C -violating,

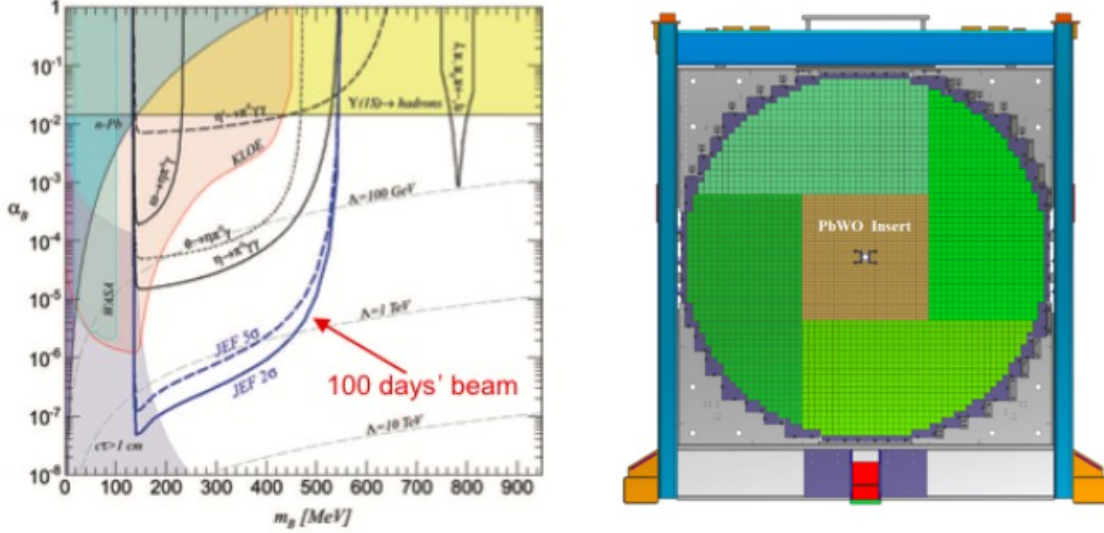

Figure 3.3: a) Current exclusion regions for a leptophobic gauge boson B' S. Tulin, Phys. Rev. D 89, 114008 (2014), with the proposed search region via $\eta \rightarrow B'(\rightarrow \gamma\pi^0)$ labelled “JEF” for the coupling versus mass plane. Dashed gray contours denote the upper bound on the mass scale Λ for new electroweak fermions needed for anomaly cancellation. b) The FCAL-II insert/upgrade, showing the new, finer-granularity PbWO_4 crystals in the centre in brown, with the original, re-stacked FCAL lead glass blocks in green.

P -conserving new forces. Work is underway on event generators and full Geant4 simulations. R&D and construction of the FCAL-II insert is at an advanced stage: detector assembly and testing has commenced at a new clean room at JLab with the Regina postdoc and Ph.D. students contributing to the efforts.

The GlueX plans for the next five years have been recently optimized to start with three publications in 2019 on beam asymmetries and the first on cross sections, which will pave the path to PWA publications planned from 2021 and beyond. The experiment will continue to run until ~ 2023 , when a shutdown is planned to start to install the FCAL-II insert for the JEF program. During the 2021–26 period, the JEF program will ramp up and continue into the next five years.

Solenoidal Large Intensity Detector, SoLID (JLab) Regina; Australia, China, France, Israel, Italy, Korea, Mexico, Russia, Slovenia, Ukraine, UK, USA

The development of the Generalized Parton Distribution (GPD) formalism in the last 20 years is a notable advance in our understanding of the structure of the nucleon. Unifying the concepts of parton distributions and hadronic form factors, GPDs are “universal objects” which provide a comprehensive framework for describing the quark and gluon structure of the nucleon. Knowledge of GPDs would allow a tomographic 3D understanding of the nucleon to be built up. They are probed experimentally through a variety of Deep Exclusive reactions, where the system responds coherently to the incoming probe. The Solenoidal Large Intensity Detector (SoLID), planned to be constructed in Hall A of Jefferson Lab in the next five years, has an open geometry and high luminosity capability which makes it optimally suited to the study of GPDs.

The Regina-led experiment will use SoLID, in conjunction with a polarized ^3He target, to probe the poorest-known GPD, \tilde{E} . The four lowest-order GPDs are parameterized in terms of quark

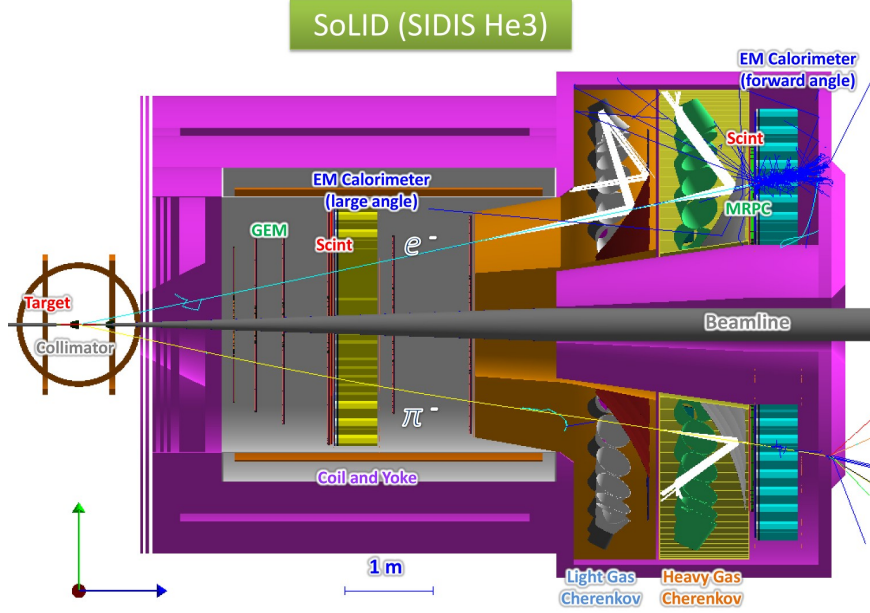

Figure 3.4: The Solenoidal Large Intensity Device (SoLID), planned for Jefferson Lab. The polarized ${}^3\text{He}$ target is at far left, and the Heavy Gas Cherenkov detector is second from right.

chirality, with \tilde{E} involving the difference between left and right handed quarks, and corresponds to a process where the proton helicity is flipped. \tilde{E} is believed to contain an important pion pole contribution, and hence is optimally studied in Deep Exclusive Meson Production (DEMP). \tilde{E} cannot be related to already known parton distributions, and so experimental information about \tilde{E} via Demp can provide new information on nucleon structure which is unlikely to be available from any other source. The experimental access to \tilde{E} is through the azimuthal variation of the emitted pions from a transversely polarized nucleon target. Since polarized ${}^3\text{He}$ is an excellent proxy for a polarized neutron, the reaction of interest is essentially $\vec{n}(e, e' \pi^-) p$. Due to their higher Q^2 , the SoLID measurements should be more readily interpretable than earlier results from HERMES, providing the first clear experimental signature of \tilde{E} .

The essential idea of SoLID is to use the latest technology detector and readout to enable an increase in luminosity by a factor of ten compared to existing detectors (such as CLAS-12). The construction of the SoLID detector, an international project estimated at US\$70M, has received very favorable feedback in scientific reviews conducted by the U.S. Department of Energy (US-DOE). The SoLID Collaboration has 300 members from 72 institutions in 13 countries, and is in an advanced stage of project planning, in anticipation of project approval in 2021. Construction and installation would extend through 2026, with the physics program to last at least 10 years. The Regina group, in partnership with Duke University, is responsible for the Heavy Gas Cherenkov detector, which will be used for forward angle pion identification. They have received funds from CFI and provincial sources for HGC prototyping. The full HGC detector is projected to cost \sim US\$4M, which is planned to be funded through a combination of CFI-IF and US-DOE funds.

3.1.2.3 Mainz Microtron

A2 Collaboration (MAMI) Mount Allison, Regina, Saint Mary’s; Croatia, Germany, Italy, Russia, Switzerland, UK, USA

As already mentioned above, a portion of the Canadian experimental research program on QCD is carried out at facilities other than than JLab. One of those is MAMI, the Mainz Microtron (Mainz, Germany), where Canadians are members of the A2 Collaboration. The Mainz laboratory provides a high-quality, high-flux continuous-wave 1.5 GeV electron beam providing a beam of polarized photons, a refurbished near- 4π CB-TAPS detector system, and a frozen-spin polarized proton target. These have allowed unique access to high-precision measurements of nucleon structure. Obtaining these new, precise nucleon-structure data is the aim of each of the experiments that have significant Canadian contributions.

Proton Spin and Scalar Polarizabilities We have conducted a program of measurements to extract the spin polarizabilities of the proton in the 250–320 MeV energy range, and scalar polarizabilities of the proton below pion threshold. Such polarizabilities are fundamental observables of hadron structure, and are amenable to calculation with various QCD-inspired models and effective theories. To extract the heretofore unknown spin polarizabilities we took data on three polarization observables in the Δ region: the asymmetries Σ_{2x} , Σ_3 , and Σ_{2z} , and to determine the scalar polarizabilities with unprecedented precision and reduced model dependence we measured the polarization observable Σ_3 at low energy for the very first time.

The results for Σ_{2x} have been published—along with a first independent determination of the individual proton spin polarizabilities—in Physical Review Letters ³. The paper for the Σ_{2z} asymmetry was recently published in PRC ⁴. The manuscript for the Σ_3 asymmetry in the Δ region with new fits for the spin polarizabilities is in preparation. The combination of all three asymmetries allows for an independent extraction of all four spin polarizabilities with small statistical and model-dependent systematic errors, and our results should be completely finalized in the fall of 2020. In order to get the statistics necessary to appreciably reduce the errors on the scalar polarizabilities, the tagging spectrometer and data-acquisition electronics were upgraded, allowing for a significant increase in the photon flux and trigger rate. Mainz Ph.D. student E. Mornacchi is in the final stages of the data analysis and we expect to publish the results by the end of 2020. It is possible that we will take more data on the Σ_{2x} observable in 2021, but this would be the final measurement on the proton part of the Mainz polarizability program.

Neutron Polarizabilities Information on the neutron polarizabilities remains extremely fragmentary, largely due to the lack of a free-neutron target. The scalar polarizabilities are poorly known compared to the proton and the spin polarizabilities are almost entirely unknown. With the help of colleagues in Glasgow and Mainz we are developing an active, high-pressure helium target for use at the centre of the CB-TAPS detector system. As our third set of polarizability experiments, we will measure elastic Compton scattering on both ^3He and ^4He , and with the help of theoretical work in the Chiral Perturbation Theory framework we will be able to extract the neutron scalar polarizabilities accurately for the first time. The proposal for this measurement has been given an “A” rating by the MAMI Program Advisory Committee and we expect to conduct this measurement in 2021 or 2022.

The neutron spin polarizabilities are of equal importance to the proton spin polarizabilities, but most neutron observables are at best poorly measured due to the nuclear effects present when

³P. Martel et al., PRL 114, 112501 (2015)

⁴D. Paudyal et al., PRC 102, 035205 (2020)

attempting to extract the neutron quantities. The neutron spin polarizabilities are no exception. Although there are some predictions, and due to isospin invariance the neutron should behave in much the same manner as the proton, there are no experimental measurements on the neutron spin polarizabilities. The only result is a “recommended experimental value” of the linear combination $\gamma_{\pi}^n = (58.6 \pm 4.0) \times 10^{-4} \text{ fm}^2$. There are, however, recent theory results in the framework of ChPT and more are on the way. Measuring the neutron spin polarizabilities would provide another important tool for testing models of QCD in the low- and intermediate-energy region. Similar to what was done for the proton spin polarizabilities, the plan for the fourth set of measurements is to use deuterated butanol in the frozen-spin target and polarized photons in the Δ region, along with theory support to attempt an extraction of the neutron quantities. The experiments should run in the middle of the decade, 2023–26, with the corresponding analysis completed and papers published by the decade’s end.

3.1.3 The longer term: The Electron-Ion Collider (EIC)

3.1.3.1 Physics Program

The EIC will uniquely address three profound questions about nucleons (neutrons and protons) and how they are assembled to form the nuclei of atoms. In addition, the EIC presents significant opportunities that connect to neutrino, high energy, particle physics and astrophysics.

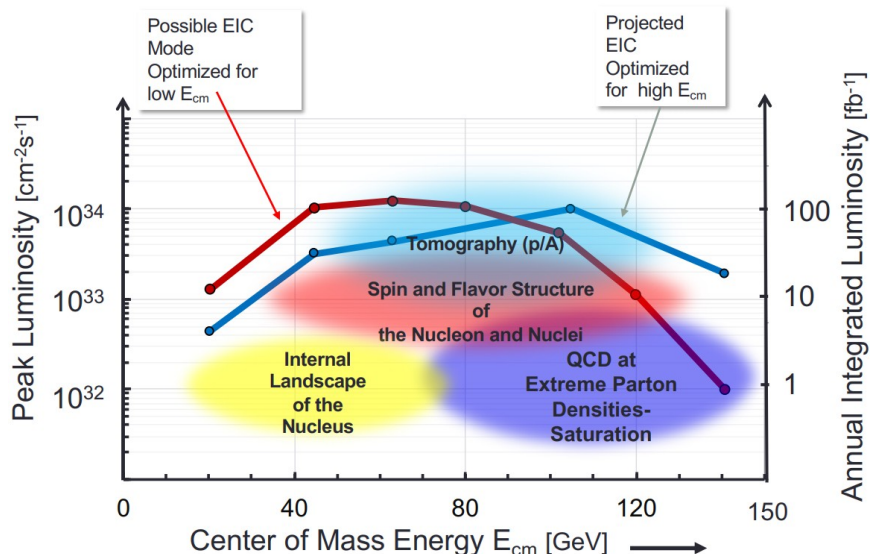

Figure 3.5: The opportunity to use a variety of electron-ion center of mass energies enables rich physics potential at the EIC, from studying the internal structure of the nucleons and nuclei, to the tomographic visualization of the correlated three-dimensional structure of the nucleon at the femtoscale. The ongoing Yellow Report process will provide input to the detailed accelerator design to identify at which center of mass energy the luminosity should be optimized.

How does the mass of the nucleon arise? The problem is that while gluons have no mass, and u , d quarks are nearly massless, the nucleons that contain them are heavy; the total mass of a nucleon is some 100 times greater than the mass of the valence quarks it contains (see Figure 3.6).

The largest contribution to the mass of the proton originates from the gluon field energy. In this sense, the source of visible mass in the universe is not the Higgs field, but the gluon field. By selecting the energy and resolution of the virtual photon, an EIC can address different regions of Bjorken x going from the regime of moderate x dominated by valence quarks to the small x regime controlled by sea quarks and gluons. These types of experiments have been carried out before, but the EIC will add several new dimensions by studying the distribution of partons in the plane transverse to the motion of the nucleon, and by determining their transverse motion. These measurements will provide tomographic images of nucleons and nuclei, to determine: the relative spatial size of the valence quark, sea quark, and gluon distributions; the spatial structure of the different contributions to the energy density and pressure forces in the nucleon; and the spatial distribution of gluons in a large nucleus.

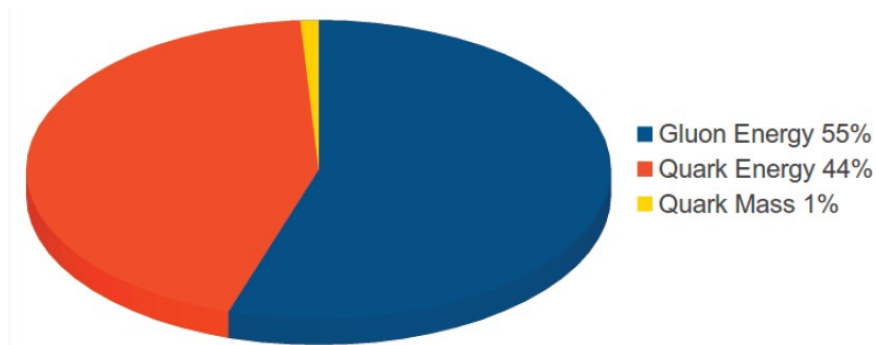

Figure 3.6: The mass of the nucleon originates not only in the mass of its constituent quarks, but overwhelmingly from the energy in its quark and gluon fields.

How does the spin of the nucleon arise? How the angular momentum, both intrinsic as well as orbital, of the internal quarks and gluons gives rise to the known nucleon spin is not understood. The quark polarization contribution to the nucleon spin is only about 30 percent. The remainder of the spin must reside in orbital angular momenta of quarks and gluons or gluon polarization. Polarized proton-proton collisions at the Relativistic Heavy Ion Collider (RHIC) have provided the first evidence for a nonvanishing gluon spin polarization in the proton. A central goal of the EIC program is to provide a determination of the gluon spin contribution and its orbital angular momentum. These measurements would be based on the resolution dependence of polarized Deep Inelastic Scattering (DIS). This dependence arises from quark and gluon partons radiating additional partons. When a polarized gluon radiates a quark-antiquark pair, the spin orientation of the gluon is transferred to the quark and the antiquark. This effect can be measured using polarized electron scattering with a polarized proton beam. The orbital angular momentum of gluons can be probed via the exclusive measurements described. Precise knowledge of the spin of gluons combined with sum rules of the generalized parton distributions (GPDs) determined in these measurements offer the possibility of isolating the contribution to the nucleon spin of the orbital angular momentum of gluons.

What are the emergent properties of dense systems of gluons? The nature of gluons in matter, i.e. their arrangements or states, and the details of how they hold matter together, is not well known. Gluons in matter are somewhat like dark matter in the universe, unseen but playing

a crucial role. The EIC would be able to study the gluons that bind quarks and antiquarks into nucleons and nuclei with unprecedented precision. A central goal of such studies is to explore the limit of low Bjorken x , where the number of gluons in the target is very large. Here, the description of the nucleus in terms of colored degrees of freedom is expected to simplify dramatically, and discovery of a new type of state composed of dense gluon matter is also expected. The EIC would also be able to explore modifications of the quark distributions in nuclei. These issues are fundamental to an understanding of the matter in the universe.

Connections with other fields Nuclear physics also includes high-priority programs in neutrino physics and fundamental symmetries. Neutrinos are messengers from hot and dense environments like the solar interior, type II supernova explosions, and cooling neutron stars. Neutrinos also provide an important window into fundamental symmetries and possible extensions of the Standard Model of particle physics. One central question is whether the neutrino is its own antiparticle, which would imply that neutrinos would violate lepton number conservation. Evidence for lepton number violation is being sought in neutrinoless double beta decay experiments, and nuclear physicists are actively working toward a ton-scale detector of such processes. Electron accelerators have also made important contributions to the study of fundamental symmetries. JLab studies parity-violating electron scattering, and a series of past and planned experiments, QWeak, Measurement Of Lepton Lepton Elastic Reactions (MOLLER), and Solenoidal Large Intensity Device (SoLID), study the evolution of the fundamental electroweak coupling, and search for physics beyond the Standard Model. An EIC would naturally extend this program, studying fundamental symmetries at higher energies.

3.1.3.2 Current Canadian effort

Multiple groups are already active in the EIC program. Below are the current and projected Canadian subatomic physics efforts at U. Manitoba, U. Regina, and Mount Allison U.

Pion form factors as probe of emergent mass generation in hadrons The elastic electromagnetic form factors of the charged pion and kaon, $F_\pi(Q^2)$ and $F_K(Q^2)$, are a rich source of insights into basic features of hadron structure, such as the roles played by confinement and Dynamical Chiral Symmetry Breaking (DCSB) in fixing the hadron's size, determining its mass, and defining the transition from the strong- to perturbative-QCD domains. Studies during the last decade, based on JLab 6-GeV measurements, have generated confidence in the reliability of pion electroproduction as a tool for pion form factor extractions. Forthcoming measurements at the 12-GeV JLab will deliver pion form factor data that are anticipated to bridge the region where QCD transitions from the strong (color confinement, long-distance) to perturbative (asymptotic freedom, short-distance) domains.

At EIC, pion form factor measurements can be extended to still larger Q^2 , by measuring ratios of positively- and negatively-charged pions in quasi-elastic electron-pion (off-shell) scattering via the $p(e, e'\pi^+)n$ and $n(e, e'\pi^-)p$ reactions, accessed with proton and deuterium beams. Huber's group at U. Regina has written an event generator and have performed simulations demonstrating the feasibility of these measurements. The measurements would be over a range of small $-t = -(p_p - p_n)^2$, and gauged with theoretical and phenomenological expectations, to again verify the reliability of the pion form factor extraction.

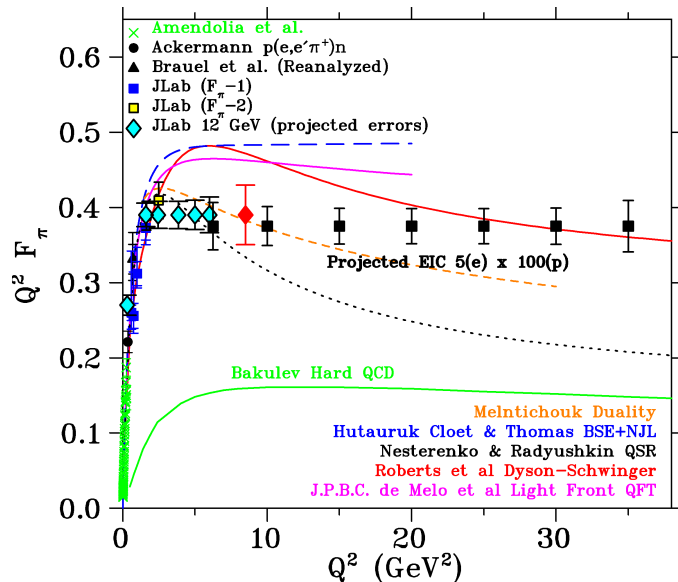

Figure 3.7: Existing data (blue, black, yellow, green) and projected uncertainties for future data on the pion form factor from JLab (cyan, red) and EIC (black), in comparison to a variety of hadronic structure models. The EIC projections clearly cover a much larger Q^2 range than the JLab measurements, providing access to the mass. These results have been published in A.C. Aguilar *et al.*, Eur.Phys.J.A 55 190 (2019).

A consistent and robust EIC pion form factor data set will probe deep into the region where $F_\pi(Q^2)$ exhibits strong sensitivity to both emergent mass generation via DCSB and the evolution of this effect with distance scale. Figure 3.7 shows the EIC projections for possible pion form factor measurements. The pion form factor projections assume an integrated luminosity of 20 fb^{-1} with a 5 GeV electron beam colliding with a 100 GeV proton beam. Simulation work to refine the eRHIC detector requirements is ongoing, as part of EIC Yellow Report efforts.

Due to its strange quark content, roughly $1/3$ of the K^+ mass is due to the Higgs mechanism, while the π^+ mass is barely influenced by the Higgs and is almost entirely generated by DCSB. Thus, the comparison of the charged pion and charged kaon form factors over a wide Q^2 range would provide unique information relevant to understanding the generation of hadronic mass. Planned simulation work for 2021-23 include extensions to the case of the charged kaon, assuming that measurements by Huber’s group at the 12-GeV JLab on exclusive kaon electroproduction beyond the resonance region at $-t \leq 0.9 \text{ GeV}^2$ and Q^2 up to $\sim 5 \text{ GeV}^2$ confirm the feasibility of this technique.

Electroweak mixing angle measurements and tests of the Standard Model Precision measurements of fundamental observables in the electroweak sector of the Standard Model have allowed us to impose strict limits on the existence of potential new physics beyond the Standard Model. Canadian subatomic physicists were instrumental in such experiments at Jefferson Lab in the PV-DIS experiment ⁵ and QWeak experiment ⁶.

The EIC presents opportunities for isoscalar hadrons, *i.e.* electron–deuteron collisions, which have never been available. Measurements of interference structure functions $F_1^{\gamma Z}$ and $F_3^{\gamma Z}$ in

⁵Jefferson Lab PVDIS Collaboration, Nature 506, 67–70 (2014)

⁶Jefferson Lab Qweak Collaboration, Nature 557, 207–211 (2018)

polarized electron–unpolarized deuteron scattering will allow for clean separation of the weak vector and weak axial-vector quark couplings, and determination of the electroweak mixing angle $\sin^2 \theta_W$ in the poorly explored region between 10 and 70 GeV (see Figure 3.8). Additionally, the measurements of $F_3^{\gamma Z}$ will improve our knowledge of the V_{ud} term in the u -quark unitarity relation for the CKM matrix, another avenue for Standard Model tests.

The EIC presents opportunities outside hadronic physics as well, for example in the area of fundamental symmetries. New channels for Standard Model tests of lepton flavor violation present themselves through $e^- \rightarrow \tau^-$ decays. At the anticipated integrated luminosities of 100 fb^{-1} , this channel holds discovery potential for leptoquarks, R -parity violating supersymmetry, leptophobic Z' bosons, and other charged lepton flavor violation theories.

In Spring 2020, the U. Manitoba members of the EIC-Canada Collaboration organized a (virtual) workshop on Electroweak and Beyond the Standard Model physics at the EIC that attracted over 80 theoretical and experimental subatomic physicists. The outcomes of this workshop are directly impacting the Yellow Report process.

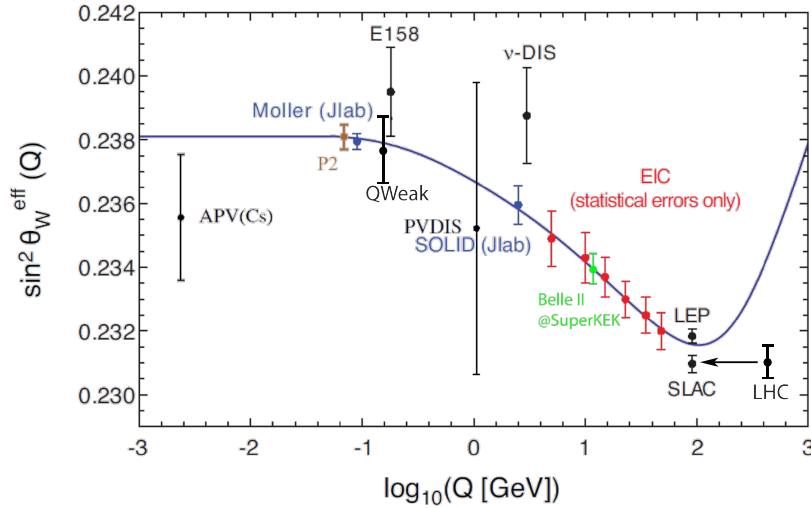

Figure 3.8: Available and anticipated (Moller, SOLID, Belle-II) measurements of the electroweak mixing angle at facilities worldwide are compared with projected measurements and their uncertainties at the EIC for a variety of kinematic conditions. The EIC projections cover an energy scale μ between the low-energy regime and the Z -pole where little data is currently available. These projections have been published in Eur.Phys.J.A 53, 55 (2017)

Accurate knowledge of the electron beam polarization is important for the electroweak mixing angle program. The U. Manitoba group plans to apply its expertise in Compton polarimetry at HERA, Jefferson Lab, and the EIC. The development of Compton polarimetry for the EIC has significant synergies with the upgrade of the Belle II facility to use polarized electrons in their high energy ring.

Light and heavy quark spectroscopy Interactions and structures are convolved with each other in nuclear matter. The observed properties of nucleons and nuclei emerge out of this complex system. Achieving an understanding of this dynamical system promises to be transformational.

Strong QCD dynamics results in many-body correlations between quarks and gluons and, as a result, hadron structure emerges. Traditionally, the manifestation of hadrons in nature has

their spectrum dominated by colorless “quark model” states — such as quark-antiquark pairs (mesons) and quark triplets (baryons) — while gluonic degrees of freedom are difficult to observe or suppressed. A question arises: how do the quark and gluonic degrees of freedom that are present in the fundamental QCD Lagrangian manifest themselves in the spectrum of hadrons?

In hadron spectroscopy there are standard quarkonium states but also a host of unexpected resonances have appeared that are not well reconciled with the usual charmonium interpretation. Specifically, one of the challenges in the charmonium sector at the moment is that if all the bumps that are seen are true resonances, it’s not clear what the underlying degrees of freedom are (multi-quark states, molecules, etc.). One great advantage of electro-/photo-production is that most of these states have been seen in e^+e^- annihilation or decays, and electro-/photo-production allows access to different kinematics which can help confirm their resonant nature and exclude them being kinematical effects; this is particular important for Z-states. In addition, not only are these states created in larger numbers than e^+e^- annihilation experiments, but one has a well-controlled initial state (e-p) which makes determining the J^{PC} of these states a lot easier than, say, at the LHC. In addition, the bottomonium exotic sector needs to be explored with sufficient detail, in order to achieve a comprehensive and consistent understanding of both sectors.

New states need to be confirmed such as $\tilde{X}(3872) \rightarrow J/\psi\pi\pi$, the observed charged charmonium structure observed by BESIII and Belle (Figure 3.9), and CLEO ⁷ in decay of $Y(4260)$ to $Z_c^+(3900) \rightarrow J/\psi\pi$ needs to be studied, as do pentaquarks ⁸ whose confirmation in photo- and electro-production will be the first step towards elucidating their nature. These studies are statistically limited at the B-factories and difficult/impossible at LHCb. Experimentally, the EIC will offer centre of mass variability with minimal loss of luminosity, which is a critical feature in the study of the onset of interesting QCD phenomena. The EIC is the perfect lab to carry out thorough studies of hadron spectroscopy and to address the remaining open questions in that field.

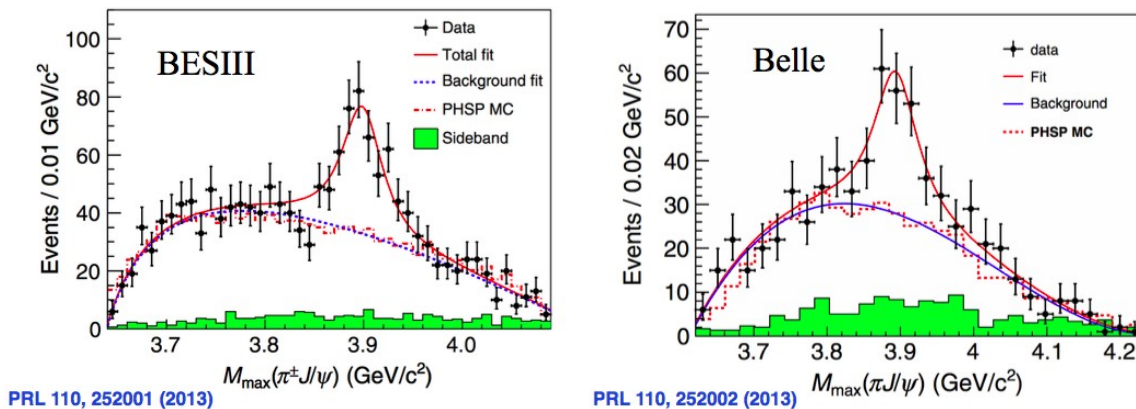

Figure 3.9: Charged charmonium structure observed by BESIII (left) Phys. Rev. Lett. 110, 252001 (2013), and Belle (right) Phys. Rev. Lett. 110, 252002 (2013) in the decay of $Y(4260)$.

An EIC Physics Working Group has been formed focusing on light and heavy spectroscopy at EIC. This group plans to demonstrate a strong physics case for a hadron spectroscopy program at EIC, which will be included in the next EIC Physics Book. Studies have commenced using event generators and simulating the kinematics which will help define the detector design. The

⁷T. Xiao et al, PLB 727, 366 (2013)

⁸A.N. Hiller Blin et al. (JPAC), PRD 94, 034002 (2016)

Regina-GlueX group that has joined the EIC Spectroscopy effort, which has a strong contingent of GlueX collaborators from the USA. Likewise, the group has joined the EIC Calorimetry group (with BNL and JLab participants) where the group’s experience in building the 30 ton sampling fraction, electromagnetic barrel calorimeter (BCAL) for GlueX will be leveraged, as will the expertise in testing and deploying silicon photomultipliers.

In the 2021–2026 period, the group will be active in using/developing event generators and simulating and smearing generated events in the EIC detector framework, to study kinematical regions and see how observables depend on acceptance, achievable resolutions, etc., towards achieving the spectroscopy physics goals and in ensuring that the developed detector(s) can meet those goals. In parallel, the effort of the Calorimetry Working group is focused on collecting information about different calorimetry technologies and simulations studies, as well as examine physics-driven requirements to ECAL and HCAL calorimetry.

During the 2026-2031 period, final design, construction and commissioning of the EIC detector(s) is planned. The group will be active in calorimetry R&D and testing, together with American colleagues from JLab and BNL. The group’s FTE and HQPs will increase during this period, as the GlueX and JEF projects in Hall D wind down.

3.1.3.3 Long Range Planning Visions

5 year outlook (2022–26) Over the next 5 years, the EIC community plans to achieve the next three critical decisions, CD-1 (alternative selection and cost range, by March 2021), CD-2 (final design, by September 2022), and CD-3 (start construction, by the 4th quarter of 2023). This aggressive schedule is only possible because of the strong international user community of over 1000 subatomic physicists working in concert with the joint accelerator design teams at Brookhaven National Laboratory and Jefferson Lab.

The EIC-Canada Collaboration anticipates that the next 5 years will be a period of growth. Opportunities exist for subatomic physics groups with detector technology expertise to join the EIC-Canada Collaboration. The current members are in leadership positions in the detector development and physics working groups, as well as the software working groups. The Canadian theorists are also interested in joining EIC working groups and committees and complementing the experiment efforts, with broad range of contributions such as e+A gluon saturation, GPDs and TMDs, radiative corrections and Lattice QCD.

By 2026, the number of Canadian PIs are anticipated to increase to 2.5 FTE and the number of HQP to 9, following the acceptance of the Canadian Expression of Interest in international detector development efforts (to be submitted in late 2020). At that point, the construction phase of a major Canadian detector component (funded through a substantial CFI investment of at least \$1.5M) will begin.

Long-term vision (2027–36) In the longer term, the Canadian detector construction and commissioning efforts will result in an increase to 15 HQP by 2029, and the start of physics data taking will result in an increase to 21 HQP supervised by 5.6 FTE. The start of the first North American collider of this century will be associated with significant scientific interest. In the first years of the 2030s, significant new results will be published by the two detector collider collaborations.

Interface with the Jefferson Lab program There is significant synergy in the physics programs of the Electron-Ion Collider and the Jefferson Lab 12 GeV facility. As the Electron-Ion

Collider program is ramping up, the Jefferson Lab 12 GeV program continues to take advantage of the energy upgrade completed in 2017. As of summer 2020, there are another 11 years of physics experiments approved for running at Jefferson Lab, with additional experiment proposals evaluated annually. The Jefferson Lab leadership is currently engaging in a 1-year idea gathering effort to define how their mission will be reshaped or expanded in the 2030s. However, this is unlikely to include a hardware project of similar scope as the Jefferson Lab 12 GeV upgrade or the Electron-Ion Collider construction. With the completion of the upgraded detector construction and commissioning (including the new Hall D GlueX experiment that is in its third year of data taking), this bandwidth has become available to Electron-Ion Collider detector design and construction efforts. While we anticipate an increasing focus on the Electron-Ion Collider program, this will not come at a cost to the Jefferson Lab 12 GeV program. In particular, the Canadian proponents remain committed to the success of the Jefferson Lab parity program, a unique program world-wide.

3.1.4 Summary

The research community involved in hadronic/QCD physics pursue a program that is rich and diverse. The many projects in the program aim to study QCD under all of its facets, from understanding the nature of the many-body problem at zero and finite temperatures, to mapping out the transition between hadronic and partonic degrees of freedom. Canadians have undertaken key responsibilities in their respective experimental collaborations, and have continued to make fundamental contributions to theory. In the years ahead, a specific example of the potential to access new physics is the successful 12 GeV upgrade of the Jefferson Laboratory, which has transformed that facility into a site that will provide unique opportunities to understand the nature of the strong interaction, the nucleon, and the nucleus. In addition, as new facilities like the proposed EIC enter an advanced stage of planning, the Canadian hadronic/QCD community is already at work, preparing its participation in detector design and development, as well as in experiment preparation. In order to realize the strong scientific potential of the new generation of experiments in which the Canadian hadronic/QCD community is involved and to enable a vigorous theoretical effort (see Section 3.5), a continued strong support of researchers and a strategic investment in HQP is necessary.

3.2 The structure of nuclear matter

3.2.1 Overview

The nucleus is one of the most challenging quantum many-body systems to describe. This is largely due to the fact that the primary modes of excitation (single-particle excitation, spherical vibrations, rotations of a deformed shape) all act on a very similar energy scale, meaning that all are observed in nature and become mixed together. The key to describing the diverse features of nuclear structure is to develop a robust and complete understanding of the nuclear force which acts between the constituent nucleons. This is a major challenge because of the enormous computational power required to describe the behaviour of tens or hundreds of nucleons, and the many contributions to the nuclear force which subtly change as a function of neutron and proton number, neutron-proton ratio, and excitation energy. Nonetheless, tremendous progress has been made in recent years in both developing the theoretical tools and frameworks which can make this link from QCD to nuclei, and in the acquirement of pertinent nuclear data that can challenge and drive forward the development of these theoretical calculations. Canadian researchers are at the forefront of this field of research and the many contributions and activities are described in this Chapter. With continued support and strategic investment, Canada is well positioned to make key contributions to the field of nuclear structure research in the coming years.

3.2.2 The Canadian program

3.2.2.1 Canadian effort in nuclear structure theory

Canada has emerged as a world-leading effort over the past 10-15 years in the field developing theoretical descriptions of atomic nuclei from first principles. The goal of these initiatives is to develop a predictive *ab-initio* theory of nuclear structure and nuclear reactions for light and medium mass nuclei. Such a theory is needed for understanding of exotic nuclei investigated at rare isotope facilities like ISAC and ARIEL at TRIUMF, for understanding of nuclear reactions important for astrophysics, for understanding of fusion reactions important for the future energy generation as well as for the testing of fundamental symmetries in nuclear processes. At the same time, it provides a feedback on the quality of inter-nucleon interactions used as input to these calculations and ultimately helps to improve our knowledge of the nucleon-nucleon interaction, and in particular of the still-not-completely-understood three-nucleon interaction.

The theoretical efforts in Canada for nuclear structure are mainly focused in the two theory groups located at TRIUMF and the University of Guelph. These groups have been developing the capability to theoretically describe light- and medium-mass nuclei as systems of nucleons interacting by forces rooted in the fundamental theory of strong interactions, QCD. Using a low-energy expansion of QCD, namely chiral effective field theory (χ EFT), one can derive forces among nucleons and their interactions with external probes in a consistent way. The χ EFT interactions are utilized and different frameworks to perform calculations of structure effects. Studies in light- and medium-mass nuclei are crucial to test such a theory and allow cross-fertilization with experiments performed both at TRIUMF and elsewhere. Indeed, an abundance of close collaborations exist between theoretical and experimental nuclear physicists which are essential in driving progress and discoveries. Detailed examples of the specific efforts being pursued by Canadian nuclear structure theorists are provided in Section 3.5 with a few of highlights given here.

The theory group at the University of Guelph employs several *ab-initio* many-body methods,

most of which can be described as Quantum Monte Carlo (QMC) simulations to produce improved formulations of nuclear forces to understand the physics of neutron star crusts and cores, neutron-rich nuclei, as well as phenomena at the interface of nuclear physics and ultracold atoms. These are non-perturbative simulations which have an excellent track record in quantum chemistry, atomic physics, and solid-state theory. A main strength of this approach is the ability to work at interfaces, whether between different theories (*ab-initio* vs phenomenology) or between different physical systems (neutron stars vs cold atoms). Some recent highlights have used local chiral EFT in light nuclei and neutron matter⁹ and made novel developments in first-principles or mean-field techniques¹⁰.

Another theoretical framework being used is the no-core shell model with continuum (NCSMC)^{11,12,13}. This approach describes the reacting system using a basis expansion with two key components: one describing all nucleons close together, forming the composite nucleus, and a second one describing the separated clusters. The former part utilizes a square-integrable basis expansion treating all nucleons on the same footing. The latter part factorizes the wave function into products of cluster components and their relative motion with proper bound-state or scattering boundary conditions. The chiral NN and 3N forces served as input for the NCSMC calculations. Some of the calculations, when appropriate, are done with the square-integrable basis expansion part only, i.e., within the no-core shell model (NCSM)¹⁴. A recent highlight using this approach is the description of the ¹⁰C nucleus scattering on the proton¹⁵ measured at TRIUMF IRIS facility which is discussed in Section 1.2.3.

The VS-IMSRG is another framework which has been developed with strong Canadian leadership. This allows us to calculate properties of light to heavy nuclei starting from only input nuclear forces and electroweak currents. A tremendous level of progress has been made in the past few years in the development of the valence-space VS-IMSRG into a world-leading and far-reaching *ab-initio* tool. The first major breakthrough allowed Researchers to capture the bulk effects of 3N forces between valence nucleons, and it was found that ground-state energies calculated with the VS-IMSRG from carbon to nickel agree with results of large-space *ab-initio* methods, generally to the 1% level or better, effectively extending the reach of *ab-initio* nuclear structure calculations to essentially all light- and medium- mass nuclei. Indeed it has now been shown with new NN+3N forces which reproduce saturation in infinite matter, that results agree well with experiment in nuclei as heavy as the Sn isotopes, published as a Phys. Rev. Lett. Editor’s Suggestion¹⁶. This new approach has been used to predict both the proton and neutron driplines which define the limits of existence up to the nickel isotopes (See Section 3.5). Its success in reproducing experimental data has resulted in a large number of joint theoretical and experimental studies in the past few years.

Together, these two theoretical approaches have also been used to address the 50-year-old puzzle of why observed β -decay rates in nuclei are found to be systematically smaller than for free neutrons. The fundamental coupling constant is quenched by a factor of about 0.75 and this was not understood. As can be seen in Figure 3.10, it has now been demonstrated with these *ab-initio* theories that this quenching arises to a large extent from the coupling of the weak force to two

⁹J. Lynn *et al*, Phys. Rev. Lett. 116, 062501 (2016)

¹⁰E. Rrapaj *et al*, Phys. Rev. C 99, 014321 (2019)

¹¹S. Baroni, P. Navratil, and S. Quaglioni, Phys. Rev. Lett. 110, 022505 (2013)

¹²S. Baroni, P. Navratil, and S. Quaglioni, Phys. Rev. C 87, 034326 (2013)

¹³P. Navratil *et al.*, Physica Scripta 91, 053002 (2016)

¹⁴B. R. Barrett, P. Navratil, and J. P. Vary, Prog. Part. Nucl. Phys. 69, 131 (2013)

¹⁵A. Kumar *et al.*, Phys. Rev. Lett. 118, 262502 (2017); Editors Suggestions and Viewpoint in Physics.

¹⁶T.D. Morris *et al.*, Phys. Rev. Lett. 120, 152503 (2018); Editors Suggestion.

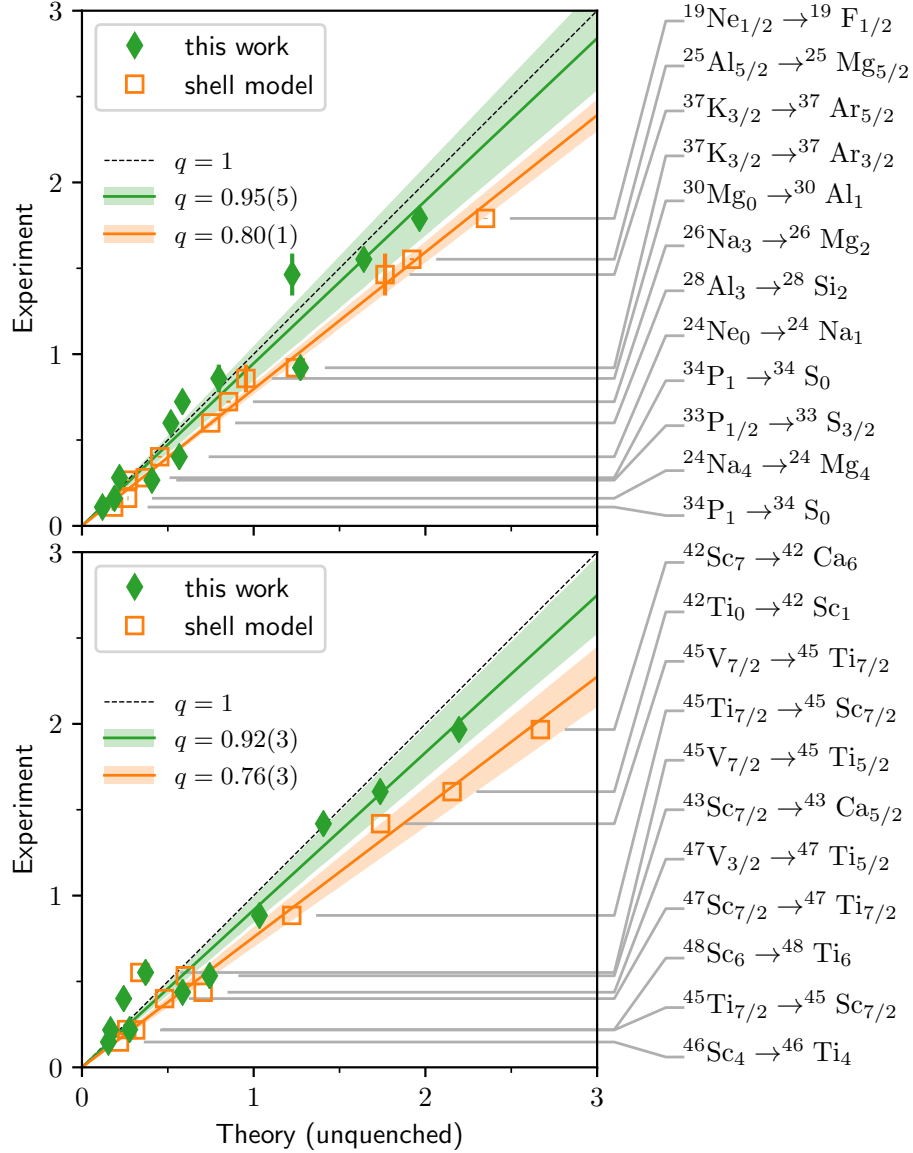

Figure 3.10: Comparison of experimental and theoretical Gamow-Teller matrix elements for medium-mass nuclei in the sd -shell (top panel) and lower pf -shell (bottom panel). The theoretical results were obtained using phenomenological shell-model interactions with an unquenched standard Gamow-Teller operator (orange squares); and using the valence-space IMSRG approach with the NN^4LO+3N_{Inl} interaction and consistently evolved Gamow-Teller operator plus 2BC (green diamonds). The linear fits show the resulting quenching factor q given in the panels, and shaded bands [P. Gysbers *et al.* Nat. Phys. 15, 428 (2019)].

nucleons as well as from strong correlations in the nucleus.

A great opportunity exists to further strengthen and grow these programs with strategic investment into HQP who can accelerate the efforts of these recognized world leaders at the forefront of an exciting and fast-moving discipline which is symbiotic with Canadian experimental efforts in nuclear physics.

3.2.2.2 Studies of neutron halos and skins

Halo nuclei probe some of the most urgent questions in nuclear physics. The classical example of a halo nucleus is ^{11}Li where the two neutrons nearest the Fermi surface are weakly bound, so that their spatial wave functions are diffuse compared to stable nuclei. These properties are confirmed by a very small two-neutron separation energy and a large inclusive reaction cross section. Many of these details were revealed by experiments led by Canadian researchers and studying the details of halo nuclei remains an insightful pursuit with new experimental results continuing to challenge the most sophisticated *ab-initio* theories.

The weakly bound exotic ^{11}Be nucleus, famous for its ground-state parity inversion and distinct $n+^{10}\text{Be}$ halo structure, was investigated from first principles using chiral two- and three-nucleon forces within the no-core shell model with continuum framework¹⁷. The explicit treatment of continuum effects was found to be indispensable and revealed that the details of the ^{11}Be spectrum is sensitive to the specifics of the three-nucleon force. It was found that only certain chiral interactions are capable of reproducing the parity inversion making this a valuable benchmark for them. With such interactions, the extremely large $E1$ transition between the bound states is reproduced. These theoretical calculations predict new features in the spectrum and have highlighted experimental short-comings in our understanding which prompts further studies.

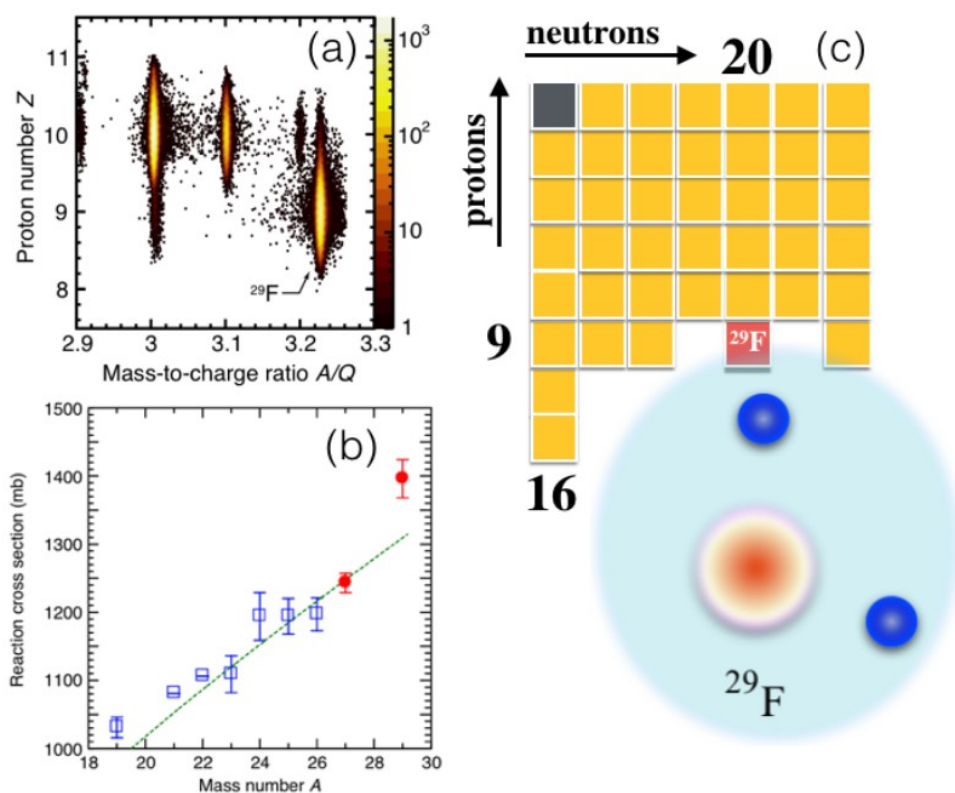

Figure 3.11: (a) Isotope identification showing ^{29}F events separated using the BigRIPS fragments separator at RIKEN. (b) Red symbols show measured reaction cross sections of $^{27};^{29}\text{F}$. (c) Nuclear chart showing the location of ^{29}F (red square) and a schematic concept of its halo structure discovered from the measurement.

¹⁷A. Calci *et al.*, Phys. Rev. Lett. 117, 242501 (2016)

Recent studies at RIKEN-RIBF in Japan have unveiled the heaviest two-neutron halo observed till date in the last bound $N = 20$ isotone¹⁸, see Figure 3.11. It is the first Borromean halo observed in the proton sd -shell. The halo is formed because of the $2p_{3/2}$ orbital unexpectedly becoming lower in energy thereby intruding into the $N = 20$ shell gap and hence making it disappear. The results are explained by state-of-the-art shell model calculations. *Ab-initio* predictions in a coupled-cluster framework are challenged in explaining the halo in ^{29}F pointing to our still limited knowledge on the nuclear force from first principles.

There are also ongoing efforts studying the ^8He and ^{11}Li systems with various ISAC experiments. It was found in a one-neutron-removal measurement using the IRIS facility that ^{10}Li resonances play an important role in the halo structure of ^{11}Li ¹⁹. Proton inelastic scattering of ^{11}Li with IRIS also revealed a large enhancement of soft dipole strength originating from the halo²⁰. These examples highlight the importance of studying a system using a variety of methods or reactions as each one probes a different aspect of the structural phenomenon. TRIUMF-ISAC remains the source for some of the highest intensities of these light beams anywhere in the world so is the venue of choice to perform such research.

3.2.2.3 Tests of *ab-initio* theories in light- to medium-mass systems

Understanding the strong nuclear force binding the protons and neutrons to form the wide variety of complex nuclei in the Universe has been a century long challenge. The shell model is, in many ways, the standard model of low-energy nuclear structure. Phenomenological shell models with valence particles (or holes) coupled to an otherwise inert core have been successful at explaining a wide range of nuclear observables such as ground-state spins, parities, binding energies, and charge radii, and excited-state properties such as excitation energies. The desire is to obtain these descriptions from first principles, rather than using phenomenology. The chiral effective field theory enables a link for a description of the nuclear force connected with the theory of quantum chromodynamics but requires certain parameters that are not uniquely defined. Strategic measurements of certain nuclear properties are necessary in order to refine the theory.

From a measurement of proton elastic scattering on ^{10}C at TRIUMF using IRIS and *ab-initio* nuclear reaction calculations, it was found that the shape and magnitude of the measured differential cross section is strongly sensitive to the nuclear force prescription (Fig. 1.1)²¹

Electromagnetic transition rates have been a particular challenge for both phenomenological and *ab-initio* shell models, and the complex interaction between valence and core nucleons was traditionally subsumed in highly phenomenological effective electric charges. Over the past decade, modern treatments of the nucleon-nucleon interaction, many-body techniques, and theoretical uncertainties have offered a means to eliminate the phenomenology of effective charges and provide testable predictions, in many cases with an accuracy exceeding the available measurements. The Canadian γ -ray spectroscopy group has focused on measurements of low-lying $B(E2)$ reduced electric quadrupole transition strengths in mirror nuclei in the the sd shell using Coulomb excitation techniques. In particular, our experiments have capitalized on a particular ISAC strength, production and delivery of intense post-accelerated beams of Mg isotopes. Measurements on the mirror

¹⁸J.S. Bagchi *et al.*, Phys. Rev. Lett. 124, 222504 (2020)

¹⁹A. Sanetullaev *et al.*, Phys. Lett. B 755, 481 (2016)

²⁰J. Tanaka *et al.*, Phys. Lett. B 774, 268 (2017)

²¹A. Kumar *et al.*, Phys. Rev. Lett. 118, 262502 (2017); Editors Suggestions and Viewpoint in Physics.

pairs ^{21}Mg - ^{21}F ²², ^{22}Mg - ^{22}Ne ²³, and ^{23}Mg - ^{23}Na ²⁴ have supported the No-Core Symplectic Shell Model, while the In-Medium Similarity Renormalization Group method was found to underpredict the average (isoscalar) $B(E2)$ strength in the pairs.

The excitation of the proton drip-line nucleus ^{20}Mg was explored using deuteron inelastic scattering with the IRIS facility and provided the first observation of its lowest resonance state²⁵. This finding has challenged the existing *ab-initio* theory predictions opening new scope to constrain the nuclear force. It was also found that there is a large deformation from excitation to the first 2^+ state suggesting a possible weakening of the $N = 8$ shell at the proton drip-line. During the 2022–2026 period it is planned to make a direct measurement of the lifetime of this sole excited state in the ^{20}Mg nucleus using TIGRESS and TIP.

The mass of neutron-deficient Mg isotopes, $^{27,28,29}\text{Mg}$ were precisely measured with the TITAN system to examine the validity of the isobaric mass multiplet equation and compare to *ab-initio* calculations²⁶.

The first direct observation of a βp^+ decay in ^{11}Be was performed using a radioactive beam of ^{11}Be provided by TRIUMF-ISAC²⁷ in conjunction with a prototype active target time projection chamber (PAT-TPC)²⁸. The branching ratio for the βp^+ channel was determined to be $1.3(3) \times 10^{-5}$, in agreement with a previous indirect measurement. This experiment shows that this decay process is sequential and proceeds through a newly identified narrow resonance with a width of 12.5 keV located at an energy of 11425 ± 20 keV. New theoretical calculations that include this resonance in ^{11}B can only now reproduce the measured branching ratio which is orders of magnitude larger than previously thought.

3.2.2.4 Evolution of nuclear shell structure

In the last decade, a significant fraction of the research programs at radioactive ion beam facilities has been driven by the observation that the traditional nuclear shell gaps, or “magic numbers”, are modified in light neutron-rich nuclei and new shell gaps such as $N=16$ and $N=32$ appear with large neutron excess²⁹. First indications of this evolution of nuclear shell structure came from anomalies in the masses of neutron-rich Na and Mg isotopes and subsequent data on excitation energies, transition strengths and spectroscopic factors have confirmed the picture of a weakening of the $N=20$ shell gap and the generation of a so-called “island of inversion” around ^{32}Mg in which deformed configurations involving 2p-2h and 4p-4h excitations across the shell gap become the ground state. The evolution of the sub-shell gap at $N=34$ established in neutron-rich ^{54}Ca ³⁰ remains the subject of intense study³¹, while strong deformation of ^{64}Cr has been interpreted in terms of the disappearance of the harmonic oscillator (sub-)shell gap at $N = 40$ in neutron-rich nuclei³². From the theoretical perspective, the microscopic origins of the evolution of shell structure in light and intermediate mass nuclei has been linked to shifts of the effective single-particle energies associated

²²P. Ruotsalainen *et al.*, Phys. Rev. C 99, 051301 (2019)

²³J. Henderson *et al.*, Phys. Lett. B 782, 468 (2018)

²⁴J. Henderson *et al.*, in preparation

²⁵J.S. Randhawa *et al.*, Phys. Rev. C 99, 021301(R) (2019)

²⁶M. Brodeur *et al.*, Phys. Rev. C 96, 034316 (2017)

²⁷Y. Ayyad *et al.*, Phys. Rev. Lett. 123, 082501 (2019)

²⁸D. Suzuki *et al.*, Nucl. Instrum. Methods Phys. Res., Sect. A 691, 39 (2012)

²⁹T. Otsuka, Phys. Scripta T152, 014007 (2013)

³⁰D. Steppenbeck *et al.*, Nature 502, 207 (2013)

³¹Y. Utsuno *et al.*, JPS Conf. Proc. 6, 010007 (2015)

³²S.M. Lenzi *et al.*, Phys. Rev. C 82, 054301 (2010)

with the central, tensor, and three-nucleon ($3N$) components of the monopole interaction between valence nucleons e.g.^{33,34}, while modifications of the spin-orbit interaction, pairing correlations, and coupling to continuum states have all been discussed in the context of shell structure evolution in heavy nuclei approaching the neutron dripline³⁵.

Mass measurements often provide the first glimpses of changes to the expected shell-model orbitals, reflected in the binding energies along chains of isotopes. Indeed as the on-line commissioning experiment of the TITAN MR-TOF, mass measurements of neutron-rich titanium isotopes³⁶ illuminated the emergence of the a subshell closure at $N=32$ and benchmarked state-of-the-art calculations performed within the VS-IMSRG framework. Additional mass measurements in the neighbouring vanadium isotopes clearly showed the $N = 32$ subshell closure is quenched with the addition of this extra proton³⁷. The VS-IMSRG calculations successfully describe the occurrence of the $N=32$ subshell closure, but are found to over-predict its strength and extent in the titanium and vanadium chains.

The state-of-the-art GRIFFIN and TIGRESS spectrometers, together with their auxiliary detection systems, provide ideal opportunities to gain new insights into the evolution of nuclear shell structure in light and medium mass nuclei. With the GRIFFIN spectrometer at ISAC-I, the evolution of shell structure in the island of inversion surrounding the neutron-rich $N=20$ nucleus ^{32}Mg has been investigated through β decay studies of ^{32}Na (experiment S1507) and $^{32,33,34,35}\text{Mg}$ (S1367). These experiments, which included high-efficiency $\gamma-\gamma$ angular correlation measurements to establish spin and parity assignments for excited states in the daughter nuclei, are currently in the analysis phase. Mass measurements in this region from the TITAN group revealed³⁸, and then confirmed³⁹, an unusual cross-over of the in the two-neutron separation energies of ^{33}Mg and ^{34}Al .

A high-statistics GRIFFIN data set for the β decay of ^{47}K studying hole states and the role of three nucleon forces in doubly-magic ^{48}Ca has recently been submitted for publication⁴⁰, while a detailed study with GRIFFIN of ^{46}K β decay to ^{46}Ca was published in⁴¹. The suggested subshell closure at $N = 34$ in the neutron-rich Ca isotopes has recently been studied in experiment S1602 through β decay studies of $^{52,53,54}\text{K} \rightarrow ^{52,53,54}\text{Ca}$ with the DESCANT neutron detector array coupled with GRIFFIN to provide a high-efficiency β -delayed n- γ coincidence detection capability.

Complementary information on shell structure evolution is obtained from experiments with accelerated radioactive beams from ISAC-II, as demonstrated by the recent measurement of spectroscopic factors in the $d(^{25}\text{Na}, p\gamma)$ reaction with TIGRESS that revealed a reduction in the $N=20$ shell gap already in ^{26}Na ⁴². This program will be extended to the associated appearance of $N=16$ as a new magic number in neutron-rich nuclei through simultaneous spectroscopic factor and excited state lifetime measurements in ^{26}Ne populated via the $^{25}\text{Ne}(d,p)^{26}\text{Ne}$ reaction in high-priority TIGRESS experiment S1702.

Canadian Researchers have also led a complementary experiment IS651 at the new HIE-ISOLDE facility at CERN. A radioactive beam of ^{28}Mg was scattered off a radioactive tritium target to populate states in ^{30}Mg after two-neutron transfer. For the first time, the full HIE-ISOLDE beam

³³T. Otsuka *et al.*, *Phys. Rev. Lett.* 104, 012501 (2010)

³⁴J.D. Holt *et al.*, *Phys. Rev. C* 90, 024312 (2014)

³⁵I. Hamamoto, *Phys. Rev. C* 85, 064329 (2012)

³⁶E. Leistenschneider *et al.*, *Phys. Rev. Lett.* 120, 062503 (2018)

³⁷M. P. Reiter *et al.*, *Phys. Rev. C* 98, 024310 (2018)

³⁸A.A. Kwiatkowski *et al.*, *Phys. Rev. C* 92, 061301 (2015)

³⁹A.T. Gallant *et al.*, *Phys. Rev. C* 96, 024325 (2017)

⁴⁰J.K. Smith, *et al.*, submitted to *Phys. Rev. C* (2020)

⁴¹J.L. Pore *et al.*, *Phys. Rev. C* 100, 054327 (2019)

⁴²G.L. Wilson *et al.*, *Phys. Lett. B* 759, 417 (2016)

energy of 9.5 AMeV was used for a transfer experiment with the MINIBALL γ ray spectrometer. The high beam energy allowed a more straightforward interpretation of spectroscopic factors compared to previous transfer experiments performed at ISOLDE. As the two-neutron transfer into the intruder $2p_{3/2}$ orbital is highly favoured, the experiment determined the amount of intruder configurations in the ground state and excited states in ^{30}Mg . These results, currently under analysis, will determine whether the transition into the island of inversion is following the surprising recent predictions⁴³ of the EKK-theory.

Opportunities at facilities employing high-energy fragmentation reactions to produce rare-isotope beams have also been utilized in the study of shell evolution. A recent example is the determination of the proton radii in neutron-rich N isotopes via charge changing cross section measurements at GSI in Germany⁴⁴. Contrary to the conventional expectation that radii increase with mass number ($A^{1/3}$), the proton radii show a decreasing trend exhibiting a local minimum at ^{21}N . This signals a neutron sub-shell closure at $N=14$ because of which the $1d_{5/2}$ orbital is fully occupied. The attractive proton-neutron interaction between the $1d_{5/2}$ neutrons (with $j = l + 1/2$) and the $1p_{1/2}$ protons ($j = l - 1/2$) is therefore strongest for ^{21}N . This causes both the $1d_{5/2}$ neutron orbital and the $1p_{1/2}$ proton orbital to become more bound causing the decrease of the proton radius.

There has been a focused effort to explore the structure of isotopes around the doubly-magic ^{132}Sn nucleus. These investigations have important implications for nuclear astrophysics in respect to the significance of these isotopes in the rapid neutron-capture (r) process. A better understanding of the nuclear structure in this region will strengthen theoretical calculations and predictions which will lead to a more precise modelling of the r process. Mass measurements of the ground states and isomers in $^{125-127}\text{Cd}$ isotopes⁴⁵ are reported from TITAN along with the $^{125-130}\text{In}$ isotopes⁴⁶. This is accompanied by detailed γ -ray spectroscopy using the GRIFFIN spectrometer. Results from are reported for the decay of beams of ^{129}In ⁴⁷, ^{131}In ⁴⁸ and ^{132}In ⁴⁹ as well as the half-lives of $^{128-130}\text{Cd}$ ⁵⁰. These studies of the daughter $^{129-132}\text{Sn}$ nuclei reveal a very complex set of structures but on different single-particle structure existing in these nuclei. In general the results are in good agreement with the latest *ab-initio* calculations.

3.2.2.5 Studies of nuclear collectivity, shape coexistence, and shape transitions

A key question in nuclear physics is how simple patterns emerge in complex nuclei. To put this another way, how do macroscopic behaviours manifest themselves from the microscopic proton and neutron interactions. In reality, it is a complex combination of excitation modes that is typically observed in nuclei and, with very similar excitation energy scales, it is often difficult to disentangle the coupled excitation modes. Many collective phenomena cannot yet be predicted from the microscopic interactions of the individual nucleons, but theoretical developments towards this ultimate goal are advancing quickly. Experimental studies are essential to elucidate the nature of excitation modes and drive theoretical advancements. A number of important contributions have

⁴³N. Tsunoda *et al.*, Phys. Rev. C 95, 021304(R) (2017)

⁴⁴S. Bagchi *et al.*, Phys. Lett. B 790, 251 (2019)

⁴⁵D. Lascar *et al.*, Phys. Rev. C 96, 044323 (2017)

⁴⁶C. Babcock *et al.*, Phys. Rev. C 97, 024312 (2018)

⁴⁷F.H. Garcia *et al.*, submitted to Phys. Rev. C (2020)

⁴⁸R. Dunlop *et al.*, Phys. Rev. C 99, 045805 (2019)

⁴⁹K. Whitmore *et al.*, Phys. Rev. C 102, 024327 (2020)

⁵⁰R. Dunlop *et al.*, Phys. Rev. C 93, 062801(R) (2016)

been made from experiments performed at TRIUMF-ISAC.

A major focus over the past 5 years has been to develop the techniques necessary to perform experiments with high-mass ($A \geq 30$) accelerated radioactive beams from ISAC-II. These efforts culminated in the successful completion of the flagship experiments to investigate the evolution of single-particle structure and shape coexistence in the neutron-rich Sr isotopes through a series of (d, p) transfer experiments with TIGRESS and SHARC. The $^{94}\text{Sr}(d, p)^{95}\text{Sr}$ and $^{96}\text{Sr}(d, p)^{97}\text{Sr}$ experiments have probed the single-particle nature of the low-lying states in the odd- A Sr isotopes as the sudden shape transition at $N = 60$ is approached, while the $^{95}\text{Sr}(d, p)^{96}\text{Sr}$ experiment has probed the neutron $s_{1/2}$ component of the shape coexisting 0^+ states in ^{96}Sr ^{51,52}. Additional analysis of the $^{95}\text{Sr}(d, t)^{94}\text{Sr}$ reaction channel has identified the previously unobserved, but expected, 0^+ states in ^{94}Sr ⁵³ to lie very close to the predicted energies and result from a strong mixing of different shapes. In contrast, co-linear laser spectroscopy performed at the TRUMF-ISAC polarizer beamline with the neighbouring Rb isotopes identified the spin (and existence) of a low-lying isomeric state in ^{98}Rb which rules out the idea of shape co-existence in the rubidium isotope chain around $N=60$ ⁵⁴. The success of these first high-mass accelerated radioactive beam experiments at ISAC-II, coupled with the other established facilities in ISAC-I, sets the stage for a broad program of nuclear collectivity and shape-coexistence studies that will be performed with TIGRESS and its auxiliary detector systems during the 2022–2026 period using the high-purity charge-bred beams of high-mass isotopes that will be provided by the new CANREB component of ARIEL beginning in 2021.

In particular, a series of multi-step safe Coulomb excitation experiments with re-accelerated $N \approx Z$ beams ranging from the doubly-magic ^{56}Ni to ^{100}Sn and along the chain of the Sn isotopes will be possible with TIGRESS in combination with SHARC or TIP for measuring transition probabilities and lifetimes of nuclear levels. Neutron-proton correlations, shape coexistence, and the evolution of shapes will be investigated in odd-odd ^{62}Ga and ^{74}Rb nuclei, while mirror symmetry and shape changes in ^{70}Br and ^{70}Se will be investigated by measuring transition probabilities. To explore whether the $N = Z = 50$ shell gap remains valid at the proton-drip line, the evolution of shell structure will be investigated in the even-even $^{100-112}\text{Sn}$ isotopes by extracting the transition probabilities of the low-lying states.

The SPICE detector, optimized for in-beam conversion electron spectroscopy with radioactive ion beams, was commissioned at ISAC-II in the past 5 years⁵⁵ and the first physics results have been published⁵⁶. This experiment, using SPICE+TIGRESS, found that the $E0$ transition strengths in ^{110}Pd are consistent with the expectations from the axial rotor model. Detailed spectroscopic studies following β decay have been performed using the 8π spectrometer and PACES in the Sn and Cd isotopes^{57,58,59} which reevaluated the nature of low-spin states and provided evidence for strong $E0$ transition branches. High-quality data sets have been acquired with the powerful GRIFFIN+PACES+LaBr₃(Ce) setup for the Hg, Er, Ce and Ge isotopes for which the data is now under analysis and the first results have been published⁶⁰. Work is also underway to couple the high-

⁵¹S. Cruz *et al.*, Phys. Lett. B 786, 94 (2018)

⁵²S. Cruz *et al.*, Phys. Rev. C 100, 054321 (2019)

⁵³S. Cruz *et al.* Phys. Rev. C 102, 024335 (2020)

⁵⁴T. Procter *et al.* Eur. Phys. J. A, 51, 23 (2015)

⁵⁵M. Moukaddam *et al.*, Nucl. Inst. And Meths. A 905, 180 (2018)

⁵⁶J. Smallcombe *et al.*, Eur. Phys. J. A 54, 165 (2018)

⁵⁷J.L. Pore *et al.*, Eur. Phys. J. A 53, 27 (2017)

⁵⁸D.C. Cross *et al.*, Eur. Phys. J. A 53, 216 (2017)

⁵⁹B. Jiggmedorj *et al.*, Eur. Phys. J. A 52, 36 (2016)

⁶⁰B. Olaizola, *et al.*, Phys. Rev. C 100, 024301 (2019)

efficiency SPICE detector with the GRIFFIN spectrometer for use in β -decay studies. The upgrade from PACES to SPICE will greatly enhance the detection efficiency and spectral quality for internal conversion electron spectroscopy. This will extend the possibilities for studies of shape coexistence in exotic nuclei not possible with the current facility. The first experiments, investigating the neutron-rich Ni isotopes around $N = 40$ with SPICE at GRIFFIN, will be performed in the next 5 years.

In a set of complementary measurements on the stable Ni isotopes led by Canadian Scientists at the Australian National University (ANU), enhanced $E0$ transitions were identified between low-lying 2^+ states^{61,62} which presently cannot be explained with existing theories. In parallel with these experimental efforts, the same group have worked with theorist Alex Brown of Michigan State University (MSU) to develop a microscopic approach to theoretical $E0$ transition strengths that dramatically improves the accuracy of calculations by capturing the polarizing effect of valence nucleons on the core⁶³.

TIP studies in the past 5 years have employed safe and unsafe Coulomb excitations as well as fusion-evaporation reactions using stable and radioactive beams from ISAC-II. A high precision lifetime measurement for the 2_1^+ state in ^{94}Sr near the shape transition region around $A = 100$ and $N = 60$ was performed using unsafe projectile Coulomb excitation⁶⁴, providing a value approximately 25% larger than previously reported while the relative error was reduced by a factor of approximately 8. As a result, a baseline deformation has been established for Sr isotopes with $N \leq 58$, which is a necessary condition for the quantum phase transition interpretation of the onset of deformation in this region. Subsequently the CsI(Tl) ball detectors have been successfully used for evaporated light charged-particle identification via pulse-shape analysis in several experiments. The data from the two proton evaporation channel in the $^{18}\text{O}+^{12}\text{C}$ fusion reaction provided the spectroscopic and DSAM lifetime measurements in ^{28}Mg ⁶⁵ needed to map the influence of the fp neutron orbitals on the structure of nuclei near the “island of inversion” centred on ^{32}Mg . This development enabled stringent testing of state-of-the-art phenomenological and *ab-initio* Shell Model calculations. Reaction channel selectivity following pulse-shape analysis of digitized waveforms has been employed using the silicon diode wall in a DSAM measurement of the first excited state reduced transition probability in the “standard candle” ^{36}Ar ⁶⁶, resolving discrepancies between previous measurements and yielding good agreement with Shell Model calculations. Finally, high-precision RDM/DSAM measurements from unsafe Coulex in $^{84,86}\text{Kr}$ nuclei^{67,68} indicated a more precipitous than anticipated reduction in the strength of the transition from the first excited to the ground state in the $N=50$ isotones approaching the $Z=40$ subshell, resulting in a more pronounced minimum at ^{90}Zr .

A major re-interpretation of the Cd isotopes has been put forward based on measurements performed with the 8π spectrometer of the β decays of ^{110}In and $^{112}\text{In}/\text{Ag}$ ^{69,70}. This work assigned rotational-like bands and, with the aid of beyond-mean-field calculations, suggested that the structures of $^{110,112}\text{Cd}$ exhibited multiple-shape coexistence. This new interpretation is illustrated

⁶¹L.J. Evitts *et al.*, Phys. Letts. B, 779, 396 (2018)

⁶²L.J. Evitts *et al.*, Phys. Rev. C 99, 024306 (2019)

⁶³B.A. Brown *et al.*, Phys. Rev. C 95, 011301(R) (2017)

⁶⁴A. Chester *et al.*, Phys. Rev. C 96, 011302(R) (2017)

⁶⁵J. Williams *et al.*, Phys. Rev. C 100, 014322 (2019)

⁶⁶P. Voss *et al.*, Phys. Rev. C 96, 024305 (2017)

⁶⁷A. Chester *et al.*, Nucl. Instr. and Meth. A 882, 69 (2018)

⁶⁸J. Henderson *et al.*, Phys. Rev. C 97, 044311 (2018)

⁶⁹P.E. Garrett *et al.*, Phys. Rev. Lett. 123, 142502 (2019)

⁷⁰P.E. Garrett *et al.*, Phys. Rev. C 101, 044302 (2020)

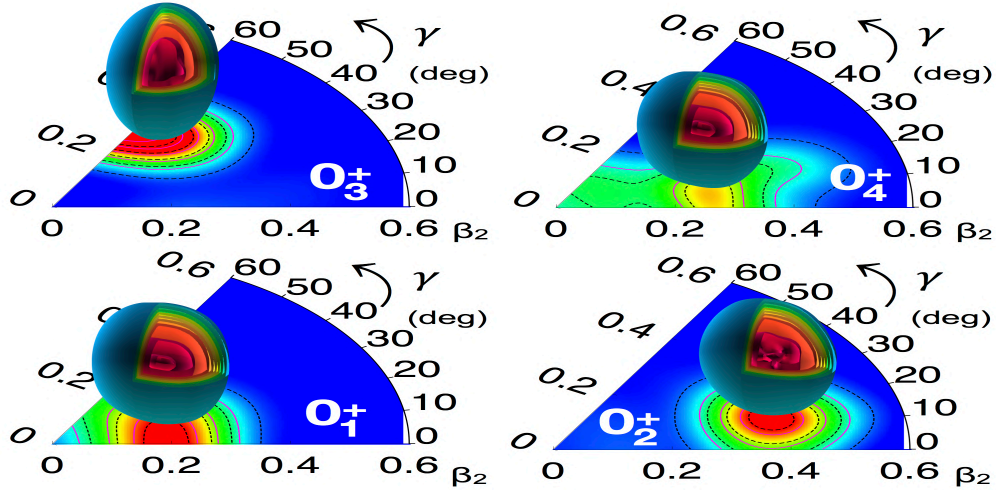

Figure 3.12: An illustration of the multiple co-existing nuclear shapes discovered in ^{112}Cd through high-precision decay spectroscopy with rare isotope beams provided by the TRIUMF-ISAC facility.

in Figure 3.12. This opens a significant opportunity for study into multiple shape coexistence since these Cd isotopes are stable and thus amenable to study with a wide variety of techniques. This work has led to new experimental programs at other facilities using a variety of experimental probes, and it is intended to revisit these β -decays to seek additional decay branches with the increased sensitivity provided by the GRIFFIN spectrometer that may permit the extension of the assigned rotational bands. Building on the previous successful experiments performed with the 8π spectrometer, shape coexistence phenomena in the semi-magic ^{118}Sn isotope⁷¹ has been investigated.

Shape coexistence in the region above doubly-magic ^{78}Ni has been investigated in the ^{80}Ge nucleus in a high-statistics decay spectroscopy experiment with GRIFFIN. The results show that shape coexistence is not present at low energies as previously reported and prompted a detailed theoretical investigation using state-of-the-art shell model calculations⁷². These studies will continue with the study of shape coexistence in ^{114}Sn [TRIUMF experiment S1916] and ^{82}Ge [S1683]. A new direction of research will be to exploit the β -decay of ^{92}Rb to probe the Pygmy Dipole Resonance that is not fully understood. The GRIFFIN spectrometer is ideally suited to performing such studies given its very high detection efficiency for γ - γ coincidences combined with the ability to perform γ - γ angular correlation measurements.

3.2.3 Experimental facilities

3.2.3.1 Experiments at the ISAC and ARIEL facilities of TRIUMF

The Isotope Separator and Accelerator (ISAC) and the future ARIEL facility are some of the world's most powerful sources of rare-isotope beams. These facilities are essential to the nuclear structure research and the various experimental setups described in this section. The details of these facilities are discussed in Sec. 4.1.1.

⁷¹K. Ortner *et al.*, Phys. Rev. C 102, 024327 (2020)

⁷²F.H. Garcia *et al.*, Phys. Rev. Lett. 125,172501 (2020)

GRIFFIN (TRIUMF) Guelph, SFU, Regina, Queen's; USA

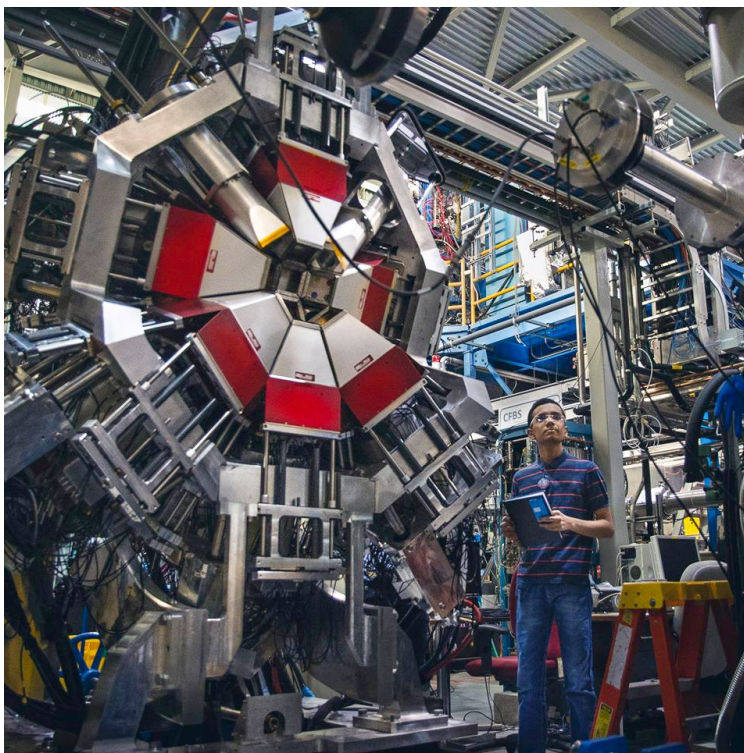

Figure 3.13: The GRIFFIN Spectrometer with its 16 Compton-suppressed high-purity germanium clover detectors arranged in a rhombicuboctahedral geometry. Undergraduate student Aditya Babu is calibrating the equipment for future measurements. Photo courtesy of TRIUMF.

GRIFFIN is a new high-efficiency γ -ray spectrometer comprised of 16 Compton-suppressed high-purity germanium (HPGe) clover detectors arranged in a rhombicuboctahedral geometry that has been optimized for γ -ray detection following the β decay of low-energy radioactive beams provided by the ISAC-I facility at TRIUMF. The first phase of the GRIFFIN project, with a total project cost of \$8.98M, was funded jointly by CFI, TRIUMF, and the University of Guelph over the 4-year period from 2011 to 2015, while the addition of the GRIFFIN Compton-suppression shields was completed through a second phase of the project funded by an additional \$3.57M award from CFI, the Ontario Ministry of Research and Innovation and the British Columbia Knowledge Development Fund over the 2016–2019 period. GRIFFIN incorporates a powerful suite of auxiliary detection systems that have also been developed by our group. Eight cylindrical Compton-suppressed lanthanum bromide crystals with a 5% doping of cerium ($\text{LaBr}_3(\text{Ce})$) placed in the ancillary triangular positions of the array are used for fast-timing lifetime measurements of nuclear levels. In the middle of the array, around the beam's implantation point, covering the upstream half of the chamber, a set of five LN_2 - cooled lithium-drifted silicon detectors (PACES) is used for conversion electron measurements. A fast 1 mm thin plastic called Zero Degree Scintillator (ZDS) can be placed just a few millimeters behind the ion-deposition point in the tape for β particle tagging. These detectors can also be replaced by another plastic scintillator detector called SCEPTAR, which consists of two sets of 10 plastic scintillators for superior β detection efficiency. GRIFFIN can also be coupled with DESCANT - 70 liquid scintillator neutron detectors that cover a 1.08π solid angle, for β -delayed neutron emission studies. The combination of this versatile suite of auxiliary detection

systems and the very high γ -ray detection efficiency of GRIFFIN forms a highly-sensitive facility for nuclear decay spectroscopy research with low-energy radioactive ion beams that is unique in the world. A comprehensive description of GRIFFIN and its ancillary detectors can be found in Nucl. Inst. Meths. A 918, 9 (2019)⁷³. The full suite of detectors is operated with a custom-built digital data acquisition system with a 100 MHz sampling frequency⁷⁴.

A series of new and upgraded ancillary detectors are under development for GRIFFIN which will enhance the experimental capabilities. A major upgrade of SCEPTAR to the Ancillary detector for Rare-Isotope Event Selection (ARIES) detector is under development at TRIUMF and will be optimized for use with GRIFFIN. The ARIES detector will come online in 2022 offering high efficiency for beta-tagging and coincidence fast-timing for LaBr₃ detectors, as well as enable $\beta - \gamma$ angular correlation measurements. The Regina Cube for Multiple Particles (RCMP) is a compact array of double-sided silicon strip detectors that is being designed by researchers at the University of Regina to surround the central implantation position of GRIFFIN. Anticipating first experiments in 2022, RCMP will extend the reach of the present GRIFFIN program towards extremely neutron-deficient nuclei by detecting charged particles (α -particles and protons) emitted from exotic nuclear decays. Of particular interest are studies of multiple-particle decay channels such as β -delayed two-proton ($\beta 2p$) and α -proton (βap) emissions that are relevant for nuclear astrophysics and give insight into the importance of particle-particle correlations in the parent nuclei.

General Purpose Station Gas Proportional β Counter and Tape System (TRIUMF) Guelph, SFU, Regina, Queen's

A 4π continuous-flow gas proportional β counter, tape transport system, and stand-alone HPGe γ -ray detector for high-precision β decay half-life measurements is operated on a separate ISAC-I low-energy beam line referred to as the General Purpose Station (GPS)⁷⁵. At GPS, the low-energy radioactive beam from ISAC-I is implanted into a 25 mm wide, 25 μm thick aluminized mylar tape of a fast tape transport system. After a collection period of ~ 4 half-lives, the ISAC beam is interrupted and the sample is moved out of the vacuum chamber through two stages of differential pumping and into the 4π gas counter. After multiscaling the signals from the counter for approximately 25 half-lives, the data are stored and the cycle repeated. Sample purity is monitored with a HPGe detector located just outside the 4π counter, or by delivering the beam to GRIFFIN, and great care is taken to investigate, and eliminate, systematic effects in order to achieve the 0.01% – 0.02% precision required for the superallowed Fermi β decay half-life measurements described in Section 3.4 below.

TITAN (TRIUMF) Calgary, Manitoba, McGill, SFU; France, Germany, Netherlands, South Korea, UK, USA

TITAN (TRIUMF's Ion Trap for Atomic and Nuclear science) is a unique ion trap experiment, currently consisting of five individual ion traps coupled together: an RFQ cooler and buncher, a Multi-Reflection TOF isobar separator and spectrometer, an Electron Beam Ion Trap, an Electron Plasma Cooler trap, and a precision Penning trap. Figure 3.14 shows a photograph of graduate student, Eleanor Dunling, holding the inner electrode assembly of the TITAN precision Penning trap. This one-of-a-kind setup has the fastest beam preparation and measurement cycle for on-line precision mass measurements (by an order of magnitude, with a duty cycle time of 5 ms, hence

⁷³A.B. Garnsworthy *et al.*, Nucl. Inst. Meths. A 918, 9 (2019)

⁷⁴A.B. Garnsworthy *et al.*, Nucl. Inst. Meths. A 853, 85 (2017)

⁷⁵G.C. Ball, Hyperfine Interact 225, 133 (2014)

providing access to isotopes with $T_{1/2} \gtrsim 5$ ms), it is the only system in the world to provide highly-charged radioactive ions, which boost the precision by one to two orders of magnitude (depending on the charge state and Z of the isotope). TITAN started in 2003 originally funded for equipment and project through an NSERC RTI, and later augmented with additional equipment from CFI and NSERC SAP RTI. The operation of the system is supported in Canada through NSERC SAP project grants. International partners have contributed as well and the estimated total capital investment in TITAN to date is \$4.5M.

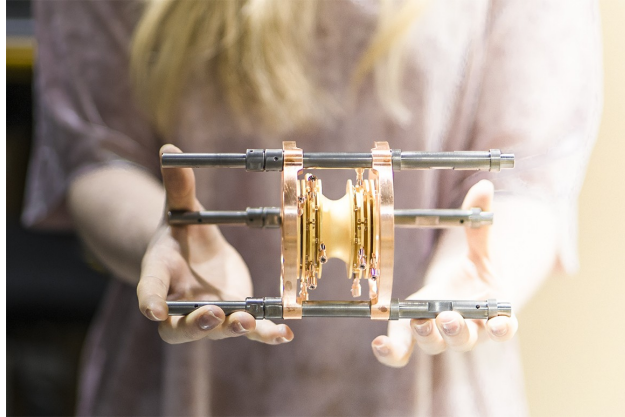

Figure 3.14: Photograph of graduate student, Eleanor Dunling, holding the inner electrode assembly of the TITAN precision Penning trap.

The core piece of the TITAN setup is the Penning trap mass spectrometer. Mass spectrometry can now be performed in two ion traps, relying either on kinematics (time of flight or MR-TOF) or on a cyclotron-frequency determination (Penning trap). The former is preferred for its high sensitivity and non-scanning technique. The latter is preferred for higher precision and resolving power (at least one order of magnitude). TITAN was the first on-line system to implement charge-breeding which can improve the precision of Penning trap mass spectrometry, be used for tertiary beam production and beam purification. The EBIT itself can also be used for in-trap γ -ray spectroscopy and in the near future the setup will be augmented with a suite of high-purity germanium detectors.

The MR-TOF, which was commissioned in 2017, has emerged as an important tool for beam development, which often hinders the timely realization of experiments. Yields can be measured simultaneously with executing the nuclear-structure and -astrophysical objectives. Thus, in the future the MR-TOF will perform the majority of the TITAN mass measurements, continue in its role of beam development, and will serve as a high-resolution beam purifier for the subsequent ion traps. The Measurement Penning Trap (MPET) was de-commissioned in 2018 and will be re-commissioned as cryogenic one with two detection techniques: the Time-Of-Flight⁷⁶ and Phase-Imaging Ion-Cyclotron-Resonance⁷⁷ techniques. The latter can improve the precision, resolving power, and sensitivity of the former; and, both benefit from higher charge states, in particular the precision. As this will remain a unique advantage among Penning-trap mass spectrometers dedicated to nuclear physics, this feature will be leveraged to pursue studies of fundamental interactions and cases requiring exceptional precision or resolving power.

⁷⁶G. Bollen, *Journal of Applied Physics* 68, 4355 (1990)

⁷⁷S. Eliseev *et al.*, *Phys. Rev. Lett.* 110, 082501 (2013)

Collinear laser spectroscopy (TRIUMF) McGill; UK, Japan, Jordan, USA

Fast beam, collinear laser spectroscopy has long been seen as a highly sensitive method with which to probe nuclear structure of ground and long lived isomeric states. When coupled to radioactive beam facilities that are capable of producing long chains of isotopes of many chemical elements these techniques provide invaluable information on the evolution of nuclear structure from stability out to the drip lines (see for example⁷⁸). The use of high resolution laser spectroscopy of the atomic electrons, which in turn directly probe the nucleus, leads to a non-destructive, highly sensitive probe that can extract subtle nuclear effects in a largely nuclear spin independent way. These properties include the ground state nuclear spin, magnetic dipole and electric quadrupole moments along with the changes in the root mean squared charge radii. In certain cases it is also possible to extract higher order effects such as the nuclear magnetisation distribution, magnetic octupole moments and the absolute charge radii. As such the results from this work have far reaching impact across many areas of nuclear physics ranging from nuclear structure through weak nucleon-nucleon interactions to fundamental symmetry tests of the standard model. through to initial measurements required in order to pursue both biomedical and material science research.

Since the implementation of the last long range plan, this collaboration has had a successful experimental program that has led to the identification and characterisation of two isomeric states in each of $^{204,206}\text{Fr}$ ⁷⁹. This found the shortcomings of the single particle model in this region of the nuclear chart as well as providing the local Francium trapping group with the information required for high precision measurements in some of these isomers. In addition to this the spin (and existence) of a low lying isomeric state in ^{98}Rb was determined, ruling out the idea of shape co-existence in the rubidium isotope chain in this region⁸⁰. This work was all made possible by a collaboration with the TITAN group at TRIUMF as the use of their radio frequency buncher was invaluable. Significant technical development was also undertaken, most notably utilising the time domain within both the data-acquisition system as well as time correlated temporal manipulation of the narrow line width laser systems. This achieved unprecedented precision and is summarised in Ref.⁸¹.

In the near future, it is expected that the CANREB facility at TRIUMF will become available. The use of the radio-frequency quadrupole buncher from this facility, as opposed to utilising the TITAN buncher, should dramatically increase the regions of the nuclear chart that are available. In general, laser spectroscopic techniques are blind to contaminants within a beam with the exception of the space charge limit of the buncher that is used. Utilising the newly developed CANREB RFQ with a significantly higher space charge limit will greatly expand the regions of the nuclear chart that are accessible without the need for complex target development.

DESCANT (TRIUMF) Guelph

DESCANT, the DEuterated SCintillator Array for Neutron Tagging, is a 70-element array of deuterated liquid-scintillator detectors that can be used with both the TIGRESS and GRIFFIN γ -ray spectrometers⁸². DESCANT currently resides at the ISAC-I facility and is used in studies of β -delayed neutron emitters with the GRIFFIN spectrometer⁸³. DESCANT forms a close-packed array that replaces the forward “lampshade” of 4 HPGe clover detectors in each of the GRIFFIN

⁷⁸P. Campbell, I.D. Moore, M.R. Pearson. *Progress in Particle and Nuclear Physics* 86, 127 (2016)

⁷⁹Voss *et al.*, *Phys. Rev. C*, 91 044307, (2015)

⁸⁰Procter *et al.*, *The European physical Journal A*, 51, 23 (2015)

⁸¹A. Voss *et al.*, *Nucl. Instr. Meth. A* 811, 57 (2016)

⁸²P.E. Garrett, *Hyperfine Interact* 225, 137 (2014)

⁸³V. Bildstein *et al.*, *Phys. Procedia*, 66, 465 (2015)



Figure 3.15: A photograph of the 70-element DESCANT neutron detector array coupled with the GRIFFIN spectrometer at ISAC-I.

and TIGRESS γ -ray spectrometers, providing high detection efficiency for neutrons in the range of ≈ 100 keV to 10 MeV. A recent experiment to study the decay of the neutron-rich K isotopes performed in 2019 measured $\gtrsim 50\%$ intrinsic efficiency for some $\beta-n$ decays, although the efficiency is dependent on the shape of the neutron spectrum. The DESCANT detectors have a 15 cm depth. With a 50 cm flight path from the source, DESCANT thus does not provide a high-resolution measurement of neutron energies via the time of flight (TOF) technique. In order to address this, a new device DAEMON (Detector Array for Energy Measurements Of Neutrons), based on thin plastic scintillator detectors, is currently being designed for use in conjunction with DESCANT. As it is presently envisioned, DAEMON would be composed of plastic scintillator bars that could be positioned directly on the front faces of the DESCANT detectors and provide energy measurements via TOF with a resolution better than 100 keV at 1 MeV.

IRIS (TRIUMF) Guelph, McMaster, Regina, Saint Mary's, SFU; Japan, UK, USA, France

The ISAC Reaction Induced Spectroscopy station, IRIS, is a facility for studying direct reactions by charged particle spectroscopy using the reaccelerated beams of rare isotopes with energies from 5-12 A MeV provided by the ISAC-II facility at TRIUMF. Construction of the facility was funded by CFI and was developed in partnership with Japan by a Canada-wide collaboration involving Saint Mary's University, University of Guelph, Simon Fraser University, McMaster University and TRIUMF. This collaboration pioneered techniques in developing thin solid hydrogen and deuterium targets (see Fig. 3.16) to boost the reaction yield, thereby allowing reaction studies of very neutron-rich nuclei possible, since they can only be produced with rather small intensity. Such a target is also



Figure 3.16: Views of the solid hydrogen or deuterium target assembly of the IRIS detector at TRIUMF-ISAC-II.

necessary to eliminate backgrounds arising from the carbon content of polyethylene foils that are typically used elsewhere. A low-pressure ionization chamber is another unique feature of the facility that makes it possible to identify beam contaminants before reaction with the target. Arrays of segmented silicon strip detectors register the reaction products. These powerful, innovative features make IRIS a major world-class facility in Canada.

Furthermore, the solid H_2 or D_2 target at IRIS is currently uniquely bringing a high degree of competitive advantage. There are several active targets in facilities around the world. The project plans for the EXACT-TPC will have some similarities to existing active targets in the world but has its advantageous feature particularly for improved gas amplification using thick GEMs and MICRO-Mesh-Gaseous Structure (Micromegas) that will allow use of pure H_2 and D_2 gases. The EXACT-TPC project is a world-wide collaboration aimed at a program that is optimally suited for TRIUMF.

TIGRESS and ancillary detectors (TRIUMF) Guelph, Saint Mary's, SFU; France, Spain, UK, USA

TIGRESS is an array of 16 Compton-suppressed 32-fold segmented clover-type HPGe γ -ray detectors optimized for in-beam γ -ray spectroscopy with the accelerated radioactive ion beams provided by the ISAC-II superconducting heavy ion linear accelerator at energies approaching or beyond the Coulomb barrier. The 32-fold segmentation of the TIGRESS HPGe detectors enables precise translation of the γ -ray energies measured in the laboratory to the rest frame of the nucleus.

TIGRESS⁸⁴ was funded by an \$8.06M NSERC RTI-3 grant over the 6-year period from 2003–

⁸⁴G. Hackman and C.E. Svensson, *Hyperfine Interact* 225, 241 (2014)

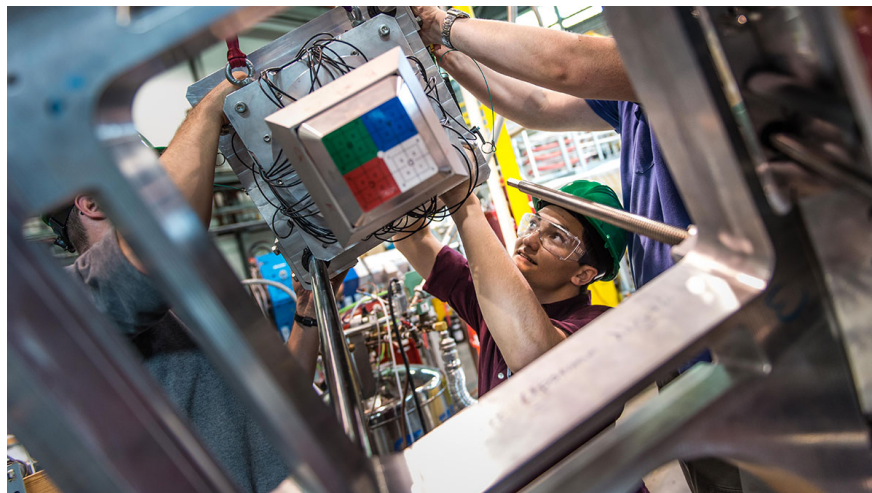

Figure 3.17: Undergraduate student, Alex Kurkjian, helping install a 32-fold segmented high-purity germanium clover detector into the TIGRESS spectrometer in the TRIUMF-ISAC-II facility.

2009, and has been augmented by more than \$2.5M of associated detectors funded through NSERC RTI and CFI awards. As in the case of GRIFFIN, the sensitivity of TIGRESS is dramatically enhanced through its coupling with a suite of specialized charged-particle and neutron detector systems that can be tailored, for each experiment, to the reaction of interest. These include: i) the Bambino detector, comprised of two 24×32 -fold segmented annular “CD-type” Si detectors, optimized for Coulomb excitation experiments with TIGRESS; ii) the Silicon Highly-segmented Array for Reactions and Coulex (SHARC)⁸⁵ comprised of up to 2000 channels of double-sided silicon strip detectors (DSSDs) with nearly 4π solid angle coverage around the reaction target at the centre of the TIGRESS array, optimized for light charged particle detection in single- and two-nucleon transfer reactions with accelerated radioactive ion beams in inverse kinematics; iii) The SPectrometer for Internal Conversion Electrons (SPICE) ancillary detector⁸⁶, a large-volume, highly-segmented lithium-drifted silicon (Si(Li)) detector located in vacuum that is shielded from direct sight of the target by a photon shield, for in-beam internal-conversion-electron spectroscopy that allows detailed investigations of shape coexistence in exotic nuclei far from stability; iv) the TIGRESS Integrated Plunger (TIP), a “plunger” device surrounded by an array of radiation-hard CsI detectors^{87,88}, the latter for identification of weak reaction products or scattered particles amongst strong backgrounds, the former for measuring lifetimes of long-lived ($\tau > 1$ ps) states; v) the TRIumf Fast Ionization Chamber (TRIFIC)⁸⁹, a tilted-plane heavy-ion gas counter for counting and identifying the nuclear charge of beam particles and beam-like reaction products and designed for rates approaching 10^6 particles per second; and, vi) DESCANT, described in Section 3.2.3.1. TIGRESS can also be coupled with the EMMA spectrometer as discussed in the next section.

EMMA and focal plane detectors (TRIUMF) Guelph, McGill, McMaster, SFU, St. Mary’s; UK

⁸⁵C.Aa. Diget *et al.*, JINST 6, P02005 (2011)

⁸⁶M. Moukaddam *et al.*, Nucl. Inst. And Meths. A 905, 180 (2018)

⁸⁷A. Chester, *et al.*, Nucl. Inst. Meths. A 882, 69 (2018)

⁸⁸J. Williams *et al.*, Nucl. Inst. And Meths. A 939, 1 (2019)

⁸⁹A. Chester *et al.*, Nucl. Inst. And Meths. A 930, 1 (2019)

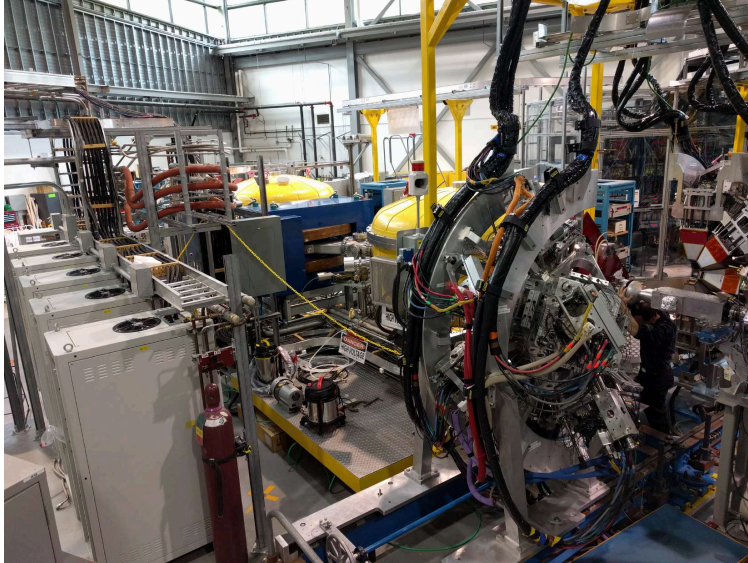

Figure 3.18: A photograph of the TIGRESS and EMMA spectrometers taken during their first experiment together in September 2019. Here the two halves of the TIGRESS support structure have been separated to allow access to the EMMA target chamber.

The Electromagnetic Mass Analyser (EMMA) is a recently-commissioned vacuum-mode recoil mass spectrometer located in the ISAC-II experimental hall. EMMA employs a symmetric configuration of electrostatic and magnetic deflectors to separate the products of nuclear reactions from the beam, focus them in both energy and angle, and disperse them in a focal plane according to their mass/charge ratios. The spectrometer was designed to couple with TIGRESS around the target position in order to provide γ -ray spectroscopic information in coincidence with the detection of heavy-ion reaction products. EMMA's design enables the measurement of fusion evaporation, radiative capture, and transfer reactions for nuclear structure and astrophysics and all of these types of reactions have been studied during its commissioning and first experiments with stable and radioactive ion beams from ISAC-II. Its complement of focal plane detectors enables the identification of recoiling nuclei and facilitates subsequent recoil decay spectroscopy. The commissioning of and initial operating experience with the spectrometer are described in⁹⁰. Currently, approximately half of all approved TIGRESS experiments involve heavy-ion detection in EMMA, and all EMMA experiments except for one require TIGRESS. TIGRESS is thus presently situated at the EMMA target location, as shown in Fig. 3.18. In anticipation of these TIGRESS+EMMA experimental campaigns, the TIGRESS and EMMA data acquisition systems have been integrated to allow the EMMA focal plane data acquisition system to either run as a fully standalone system or as a second data stream sharing the same clocks and time-stamps as TIGRESS with the data time-correlated offline. This new data acquisition scheme was validated in 2018 and used for first experiments in 2019. Future developments include SHARC-II, a charged particle detector specifically designed for TIGRESS+EMMA experiments, and associated data acquisition upgrades leveraging technologies initially designed for GRIFFIN but also used in ALPHA-g and to be used with RCMP (described in Section 3.2.3.1).

⁹⁰B. Davids *et al.*, Nucl. Instrum. Meth. Phys. Res. A 930, 191 (2019)

The 8π Spectrometer (SFU) TRIUMF

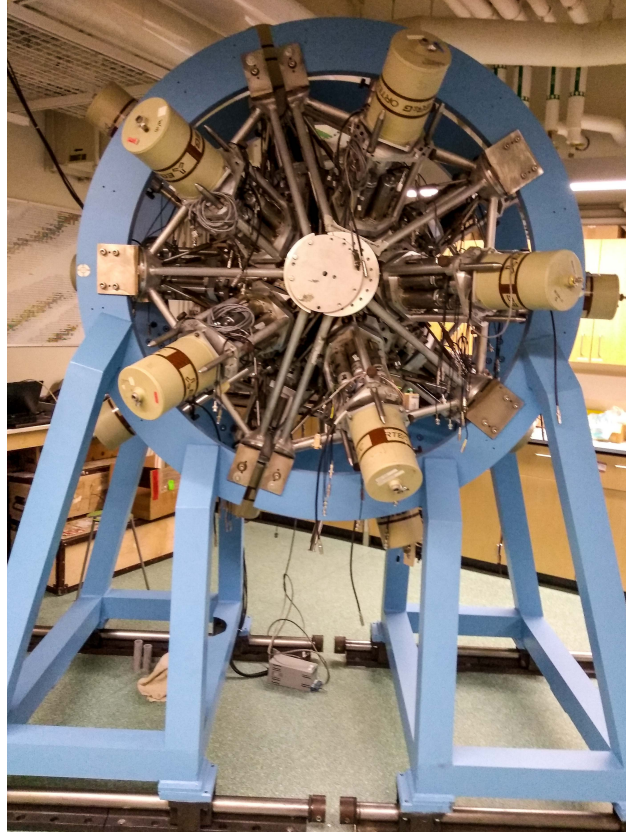

Figure 3.19: The 8π spectrometer in the Nuclear Science Laboratory at SFU.

The possibility of studying the structures of nuclei far from stability via spontaneous fission was recognized when large arrays of γ -ray detectors became effective in disentangling the complex and rich spectra from fragments emitted in the fission of ^{252}Cf and ^{248}Cm ⁹¹. The operation of a 14.1 MeV deuterium/tritium neutron generator at the SFU Nuclear Science Laboratory⁹², combined with the 8π γ -ray spectrometer⁹³ relocated from TRIUMF, offers many opportunities for studies of the products of nuclear reactions induced by fast neutrons. The goal for the upcoming LRP cycle is to deploy the 8π spectrometer, including the BGO calorimeter and all 20 Compton-Suppressed HPGe detectors as a powerful combination for the study of fission fragments produced in thick-sources (Shown in Figure 3.19). High-fold γ -ray gating on HPGe data will be used for fission fragment identification while the total γ -ray energy and multiplicity data from the BGO calorimeter will provide information on energy and angular momenta distributions for a given mass split. These measurements will be unique as previous arrays could not match the sensitivity of the 8π BGO calorimeter.

⁹¹I. Ahmad and W.R. Phillips, *Rep. Prog. Phys.* 58, 1415 (1995)

⁹²J. Williams *et al.*, *Radiat. Prot. Dosimetry* 171, 313 (2016)

⁹³A. B. Garnsworthy and P. E. Garrett, *Hyp. Int.* 225, 121 (2014)

3.2.3.2 International collaborations and Canadian-driven programs at offshore laboratories

PREX and CREX (JLab) Manitoba, Winnipeg; Croatia, Italy, Slovenia, Ukraine, USA

PREX II proposes to measure the neutron radius of lead to a precision of 1% and will provide crucial information about the neutron matter equation of state (EOS) at nuclear densities, anchoring nuclear structure theories and potentially providing evidence for nuclear matter phase transitions⁹⁴. The CREX experiment proposes to make a 0.9% measurement, and will connect the regions of the nuclear landscape that can be calculated using *ab-initio* techniques that are not computationally feasible for lead. They both have implications for neutron star structure, heavy ion collisions and atomic parity violation (APV).

The capability of JLab to produce highly polarized, high current, stable electron beams makes it the only existing laboratory to carry out such an experiment at the required energies and statistical precision. Advances in experimental techniques have made it feasible to use parity violation in the weak interaction to measure various nuclear and nucleon properties. By measuring the parity-violating asymmetry A_{PV} in elastic scattering of longitudinally polarized electrons from an unpolarized nucleus, it is possible to measure the weak form factor $F_W(Q^2)$ ⁹⁵. Because the Z boson couples mainly to neutrons, the weak charge density distribution can be related to the neutron density. The “neutron skin” is defined as the difference in the RMS neutron and proton distributions, $R_n - R_p$, of a nucleus.

PREX II (E12-11-101) ran successfully in summer and early Fall of 2019. CREX (E12-12-004) began in fall 2019 and was scheduled to complete data-taking in spring 2020. The experimental run was paused due to COVID-19, and as of the writing of this brief, is planned to resume data-taking during the summer of 2020. PREX II has presented preliminary results at the October 2020 APS DNP meeting which agree with the large central value found in the PREX I result, but with a smaller uncertainty. The analysis of the CREX data should be complete by the end of 2022, and some students will need to complete their theses. There is a future experiment, MREX, which has been proposed to run at the new Mainz accelerator, which would further improve the uncertainty on the neutron skin of heavy nuclei, but there are no plans within our group to apply for NSERC funding related to this experiment at this time.

Studies using reactions of relativistic rare-isotope beams (GSI/FAIR (Germany), RIBF (Japan), NSCL/FAIR(USA)) Saint Mary’s, TRIUMF; China, Germany, Japan, the Netherlands, Slovakia, Spain, UK, USA

This impactful research program uses the reactions of high-energy beams of exotic nuclei on various targets to determine the neutron skin thickness and discover nuclear halos through measurement of their nuclear radii. This research seeks to unveil exotic nuclear forms, neutron halos, neutron skin and new arrangements of nuclear shells in nuclei approaching the edges of the bound nuclear landscape. The thick neutron-dominated surface emerging in these nuclei provides laboratory access to gain knowledge on the equation-of-state of asymmetric nuclear matter that describes the characteristics of neutron-rich cosmic environments such as neutron stars and supernovae. The rare isotopes produced at the in-flight facilities with relativistic energies are crucial to enable these discoveries through direct reactions.

The technique used is measurements of the interaction cross section and charge-changing cross

⁹⁴F.J. Fattoyev, J. Piekarewicz, and C.J. Horowitz, *Phys. Rev. Lett.* 120, 172702 (2018)

⁹⁵T.W. Donnelly, J. Dubach and I. Sick, *Nucl. Phys. A* 503, 589 (1989)

section. These cross sections analyzed using the Glauber model reaction theory are used for determining the matter radius and proton radius. Nuclear orbitals are investigated through nucleon knockout reactions measuring nucleon momentum distributions. The nuclear radii also reflect on nuclear orbitals.

This program exploring reactions with relativistic rare isotope beams is carried out at the world's foremost in-flight rare isotope facilities at GSI-FAIR in Germany, RIBF-RIKEN in Japan and NSCL/FRIB in USA. These facilities have been the discovery frontiers unearthing new isotopes with their novel characteristics and expanding our knowledge of the nuclear landscape. Rare isotope science is at the international frontline of nuclear physics research. Its impactful discoveries led to a Nobel Symposium on the physics with radioactive beams being held in 2012.

Measurements of β -delayed neutron emitters at the RIBF, RIKEN, Japan (RIKEN) TRIUMF, McMaster; Chile, Hong Kong, Japan, Poland, Spain, UK, USA, Vietnam

The BRIKEN collaboration has the goal to measure half-lives and neutron-branching ratios of ≈ 600 β -delayed neutron-emitters until 2021, for direct input into astrophysical models for a better understanding of the nucleosynthesis of heavy elements in the r -process. This new experimental data will also drive the development of nuclear structure models to reproduce these results and predict the properties of additional nuclei which cannot be accessed experimentally. See Section 3.3.3.2 for further details.

International involvement in ISAC Another aspect of the international involvement of the ISAC and Canadian nuclear structure community in the world-wide effort should not be overlooked; this is the presence of foreign researchers and students driving science programs at TRIUMF. The vast majority of experiments performed at ISAC include collaborators from foreign institutions, often as the principal investigators of the study. Most of the major pieces of experimental equipment at ISAC have international participation, both financial and specialist expertise, in their construction and in their operation.

As a recent example, the first direct observation of a βp^+ decay in ^{11}Be was performed using a radioactive beam of ^{11}Be provided by TRIUMF-ISAC⁹⁶ in conjunction with a prototype active target time projection chamber (PAT-TPC)⁹⁷ built in the USA. The branching ratio for the βp^+ channel was determined to be $1.3(3) \times 10^{-5}$, in agreement with a previous indirect measurement. This experiment shows that this decay process is sequential and proceeds through a newly identified narrow resonance with a width of 12.5 keV located at an energy of 11425 ± 20 keV. New theoretical calculations that include this resonance in ^{11}B can only now reproduce the measured branching ratio which is orders of magnitude larger than previously thought.

3.2.4 Beyond the next five years

There are many exciting developments planned for the next five to fifteen year period which will position Canadian scientists to make important contributions and discoveries in subatomic physics. With appropriate funding and investment in this field, Canadians will remain in a world-leading position for the foreseeable future.

On the theoretical side, global *ab initio* calculations of all nuclei may well become possible in the next five to fifteen years, making statistical analyses of properties and the limits of nuclei from first

⁹⁶Y. Ayyad *et al.*, Phys. Rev. Lett. 123, 082501 (2019)

⁹⁷D. Suzuki *et al.*, Nucl. Instrum. Methods Phys. Res., Sect. A 691, 39 (2012)

principles calculations a reality. One particular challenge to overcome for this to be possible is the development of *ab initio* theory which accurately describes nuclear deformation. Such achievements will give us the capability to provide first principles input for nucleosynthesis codes well into the r-process region, or nuclear structure predictions of heavy and super-heavy systems. Of course advances in quantum computing could tremendously speed up all these initiatives, and Canadian researchers are currently exploring these directions.

ARIEL will be a next-generation rare-isotope beam facility utilizing the Isotope-Separation-OnLine (ISOL) method for beam production. The ISAC facility first brought rare-isotope beam science to TRIUMF over twenty years ago and continues to be the world's highest-power ISOL facility. While the next-generation Fragmentation facilities such as RIKEN, FRIB and FAIR offer exciting research prospects, ISOL produced rare-isotope beams are ideally suited for world-leading research in nuclear structure, nuclear astrophysics and fundamental symmetries. ARIEL will ultimately triple the number of beam hours available for science with the addition of two new target stations; one for photo-fission using electrons from the eLINAC, and one served by a new proton beamline, plus a symbiotic target dedicated to medical isotope production. There are so many exciting opportunities for the development of new rare-isotope beam species, higher intensities, cleaner beams and longer experiment running periods which will enable a whole host of new discoveries. ARIEL will be the world's most powerful ISOL complex and the only purpose-built multi-user rare-isotope facility in the world. Completion of ARIEL positions Canadian researchers in a very strong position for subatomic physics research over the next decades.

A number of new detector systems, such as the EXACT-TPC and the RCMP detectors, will be commissioned at ISAC in the next few years and will begin their science programs. Many other existing detectors at ISAC will undergo upgrades and revitalization in the next five to ten years to maintain competitiveness or to expand their capabilities as new opportunities present themselves.

These exciting developments will allow new directions of research to be pursued. At this moment it is not possible to predict what these will be. There will be a number of self-selection and peer-review processes in order to identify the most promising research programs to pursue. To give one example, the nuclear structure features related to the stability of the super-heavy elements may be explored. This is a subject not actively being pursued by Canadian researchers at this time, but new capabilities enabled by ARIEL may allow reactions with accelerated beams of very neutron-rich nuclei to access such physics.

Nuclear structure investigations relevant to neutrinoless double beta decay may also gain momentum as a future direction. Presently a handful of initial such studies have been completed or are proposed. However, at this time a number of neutrinoless double beta decay experiments are now operating in Canada or are in the planning stage. The nEXO collaboration are pursuing a ^{136}Xe -based double-beta decay experiment located at SNOLab. The LEGEND Collaboration, which has formed primarily from the GERDA and MAJORANA collaborations, aims to develop a phased, ^{76}Ge -based double-beta decay experimental program with discovery potential at a half-life beyond 10^{28} years. SNOLab is one location under consideration for the LEGEND detector. With these experiments located in Canada there would be good opportunity for collaboration with nuclear structure experts because accurate nuclear structure calculations are essential for producing the final results of these large-scale experiments.

3.2.5 Summary

Nuclear structure research in Canada addresses a range of topics which are of interest in the field today. The research efforts are primarily focused on experiments performed at the TRIUMF-ISAC facility but are also complemented by experiments performed at other laboratories worldwide. There has been significant Canadian capital investment into the ISAC and ARIEL facilities as well as the individual experimental facilities that have been described in this section. In fact several major pieces of equipment at ISAC have recently been commissioned or have undergone major upgrades. Therefore, in the 2016 to 2026 time period, Canadian researchers are in an excellent position to reap the benefits of these investments by making scientific discoveries in nuclear structure. The timely completion of the ARIEL-II project will be a major enhancement to the rare-isotope beam physics opportunities available at TRIUMF and will ensure Canadian leadership in this exciting research field.

3.3 Nuclear Astrophysics in Canada

3.3.1 Overview

The ultimate goal of all world-wide efforts in Nuclear Astrophysics is the complete understanding of the astrophysical origin and the production processes that make up all the visible matter around us. This quest is strongly connected to the theoretical understanding of the quantum many-body problem of the atomic nucleus that would enable a reliable prediction of the properties of all nuclei from the proton- to the neutron-dripline.

The interpretation of the observed solar abundances (see Fig. 3.20), from hydrogen up to uranium, is a long-standing problem. The basic foundation was already laid in 1957 by Cameron⁹⁸ and Burbidge, Burbidge, Fowler, and Hoyle⁹⁹. Since then, generations of stellar modellers have worked hand in hand with experimental nuclear astrophysicists and theoretical nuclear physicists to better understand the underlying astrophysical processes and to finetune and constrain the astrophysical and nuclear physics inputs.

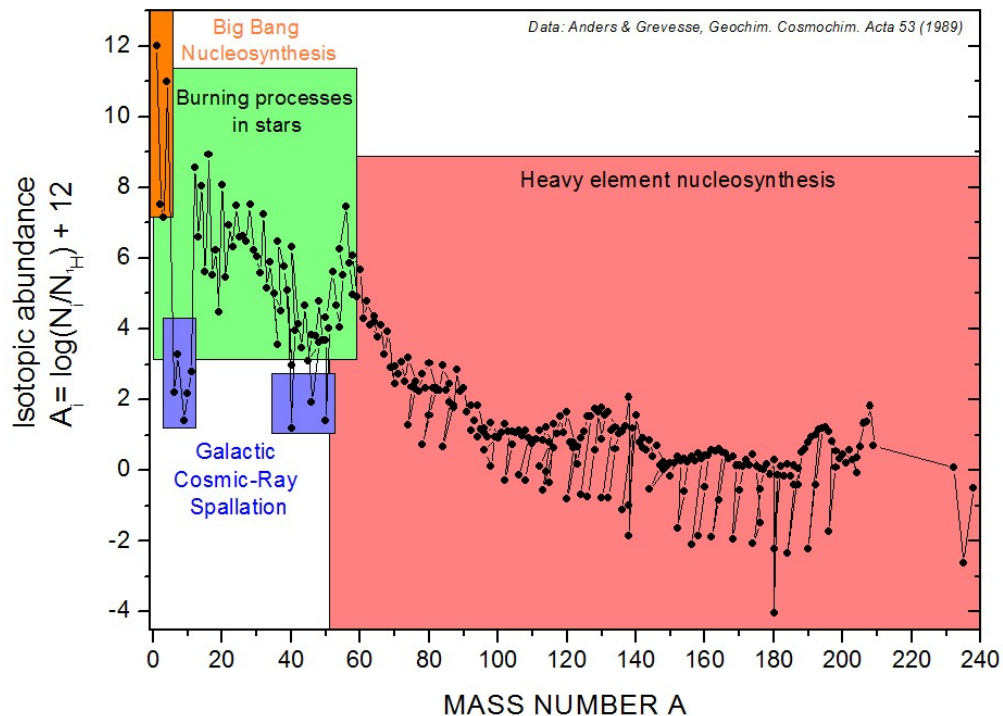

Figure 3.20: Measured (observed) solar abundances of the stable nuclides. The different regions for astrophysical productions processes are marked in color.

How well do we understand the different nucleosynthesis processes nowadays? Despite the tremendous efforts in the past six decades, experimental nuclear astrophysics has just scratched at the surface of its possibilities. So far only half of the total number of nuclei that are expected to exist between the neutron- and proton-dripline have been discovered, about 3450 nuclei. Another ≈ 4000 nuclei are awaiting discovery, the vast majority of them are on the neutron-rich side and will decay by β -delayed neutron emission.

⁹⁸A.G.W. Cameron, *Publ. Astron. Soc. of the Pac.* 69, 201 (1957)

⁹⁹E.M. Burbidge et al., *Revs. Mod. Phys.* 29, 547 (1957)

However, not all of these nuclei and their nuclear properties need to be investigated to improve our understanding of the creation of elements. So-called "sensitivity studies" have helped to identify the most important nuclear properties and regions of nuclei that need to be measured to better understand the creation of nuclei in stars and astrophysical events. Such efforts are important to guide the future experimental program where competition for beamtime will be large.

With the detection techniques established and refined at the present facilities, the community is looking forward to an exciting future with the several of the next generation of radioactive ion beam (RIB) facilities becoming operational in the next decade.

3.3.2 The Canadian program

The Canadian community is focusing their efforts on main aspects around the Big Question "*What is the role of radioactive nuclei in shaping the visible matter in the universe?*". There is also a very lively experimental program around astrophysical reaction studies of stable nuclei but the focus in the upcoming decades will be to fully exploit the new possibilities with radioactive beams, at domestic facilities like ISAC and ARIEL at TRIUMF, as well as at major RIB facilities and at smaller accelerators abroad.

The detection of the gravitational wave signal GW170817 from a binary neutron star merger (see Sec. 1.2.4) has led to a worldwide boost in public awareness for the creation of elements and how radioactive beam facilities and stellar modellers help to understand these complex topics better since we are all made of stardust.

Canadian scientists are already deeply involved in this "multi-messenger" astrophysics since many years and have taken leadership roles thanks to the diverse nuclear (astro)physics research that is enabled by the ISAC facility at TRIUMF. Still, the next decade will be the most exciting since developments on the experimental frontier (new facilities, like ARIEL, FRIB, FAIR) and on the theoretical frontier (new models and descriptions) will allow unprecedented progress in nuclear astrophysics.

3.3.2.1 Summary of the program

The majority of the domestic experimental program is carried out at the ISAC facility at TRIUMF (Sec. 4.1.1.2) and complemented by offshore-activities in Germany, Japan, and the USA (Sec. 4.2). This program is closely connected to the recent [White Paper for the Canadian Long Range Plan for Astronomy and Astrophysics 2020](#) where many of the Canadian nuclear astrophysicists were co-authors.

The experimental efforts (see Sec. 3.3.3) aim at the measurement of various nuclear physics quantities that are direct or indirect input parameters in astrophysical calculations of various stellar events:

- The CREX/PREX-II collaboration at Jefferson Lab is aiming at a more precise determination of the neutron skin thickness of ^{48}Ca and ^{208}Pb . These measurements will help to constrain the density-dependence of the symmetry energy of neutron-rich nuclear matter, which has for example implications on the equation of state and thus on the structure of neutron stars and supernovae explosions.
- The DRAGON and EMMA recoil separators and their auxiliary detectors, as well as the TUDA detector measure the resonance strength and cross sections of reactions that take place in various nucleosynthesis processes.

- Ion trap facilities like TITAN and CPT are measuring the masses of the participating radioactive nuclei to high precision. Masses are the most important nuclear physics input parameter for astrophysical abundance calculations since they determine the reaction path.
- High-efficiency decay spectrometers like GRIFFIN and TIGRESS in combination with their many auxiliary detectors allow to investigate the evolution of the shell structure or reaction rates. GRIFFIN can measure decay half-lives and lifetimes of excited states as well as extract deformation parameters and neutron emission probabilities which e.g. influence the reaction path in the rapid neutron capture process. TIGRESS coupled to EMMA allows e.g. the tagging of γ -rays emitted in radiative capture reactions.
- Moderated neutron detectors like the BRIKEN array at RIKEN Nishina Center or the BELEN detector at GSI/FAIR measure the half-lives and neutron emission probabilities of the most neutron-rich heavy nuclei that can presently be produced. These nuclear properties are important ingredients for a better description of the final abundance distribution of the r process.
- Time-of-flight neutron scintillators like DESCANT and the pseudo-bar neutron array of TexNeut and its planned Canadian successor allow to detect neutrons and their energies from decays and reactions. They can be coupled to a multitude of setups at ISAC, e.g. DESCANT with GRIFFIN and TIGRESS, and the pseudo-bar neutron array will allow operation with EMMA and IRIS.
- Indirect studies of neutron capture cross sections via (d,p) reactions are carried out with the EMMA recoil separator and the TIGRESS γ -ray spectrometer with either TI-STAR or SHARC as particle detectors, or offshore via β -decay spectroscopy in the USA with the SuN total absorption spectrometer. These studies help to constrain the nuclear level density and γ -ray strength function for a better theoretical description of yet unmeasured cross sections.

The efforts of the theoretical astrophysics community in Canada are also very diverse and support many aspects of the aforementioned measurements. The two main groups covered under the CINP umbrella are located at the University of Guelph and at TRIUMF:

- The nuclear (astro)theory group at the University of Guelph aims to provide answers to long-standing overarching questions related to nuclear forces, novel states in nuclei and matter, as well as the behaviour of matter at thermodynamic extremes found in neutron stars, their mergers, accretion disks around black holes, and supernovae. This by will be achieved by employing novel chiral effective field theory (χ EFT) interactions for both medium-mass nuclei and neutron-star matter.
- At TRIUMF, the goal of the theory group is to develop a predictive *ab-initio* theory of nuclear structure and nuclear reactions for light and medium mass nuclei. The method primarily used in this project is the no-core shell model with continuum (NCSMC), capable of simultaneous description of bound and unbound states from first principles. A novel many-body approach is the valence-space formulation of the in-medium similarity renormalization group (VS-IMSRG), which can be thought of as an *ab-initio* shell model approach to atoms and nuclei, using electromagnetic and the latest two- and three-nucleon forces, respectively.
- TRIUMF in collaboration with nuclear astrophysicists from Los Alamos National Laboratory and the University of Notre Dame in the USA is investigating new "reverse engineering"

tools for constraining yet unmeasured nuclear physics parameters from the deduced solar abundances for the r-process. This method will help to guide future experimental campaigns for the measurement of nuclear properties in the neutron-rich "Terra Incognita".

Theoretical and experimental nuclear astrophysics efforts in Canada are strongly connected by two Joint Centers, the "Joint Institute for Nuclear Astrophysics - Center for the Evolution of Elements" (JINA-CEE) in the USA and the Astronomy Research Center (ARC) at the University of Victoria.

Joint Institute for Nuclear Astrophysics - Center for the Evolution of Elements (JINA-CEE) (USA) McGill, TRIUMF, Victoria; Australia, Brasil, China, Germany, Hungary, Italy, Israel, Japan, Jordan, Netherlands, Sweden, UK, USA

In the USA the [Joint Institute for Nuclear Astrophysics - Center for the Evolution of Elements \(JINA-CEE\)](#) is a multi-institutional Physics Frontiers Center funded by the US National Science Foundation. JINA was founded in 1999 as joint venture between the University of Notre Dame, Michigan State University, and the University of Chicago and has been supported from 2002-2020 as a NSF Physics Frontiers Center. The interdisciplinary and multinational JINA-CEE network involves 26 institutions and about 300 scientific participants from all over the world, including about 240 students and postdocs. Participating Canadian institutions include scientists from the University of Victoria, TRIUMF, and McGill University.

JINA-CEE addresses fundamental questions about the cosmos, like "*Where do the elements come from that make up our world?*" and "*What are basic properties of matter when compressed to high density?*". It has organized many workshops and conferences where Canadian Nuclear Astrophysicists took part and also received (partial) travel support. JINA-CEE has also co-sponsored the [TRIUMF Summer Institute about "Modern Tools in Nuclear Astrophysics"](#) in 2017 and provided travel support for participating students.

International Research Network for Nuclear Astrophysics (IReNA) (USA) Victoria; Canada, Europe, Japan, USA

[IReNA](#) is US National Science Foundation AccelNet Network of Networks. It connects six interdisciplinary research networks across 17 countries to foster collaboration, complement and enhance research capabilities in the US and abroad, and thus greatly accelerate progress in science. An important component of IReNA is the training of students and other young researchers in an unique interdisciplinary, collaborative, and international environment.

IReNA connects this broad range of observations with the extraordinarily broad range of experimental and theoretical nuclear physics studies and advanced computational models needed to truly create new windows into the physics of the universe.

Astronomy Research Centre (ARC) (University of Victoria) NRC Dominion, NRC Herzberg, TRIUMF

The [Astronomy Research Center \(ARC\)](#) was launched in 2015 as a communication platform to increase awareness and opportunities in astronomical research at the University of Victoria. It brings together world-renowned researchers with the expertise to answer many basic questions about our universe. Scientists from the University of Victoria work closely with local researchers from BC at the NRC Herzberg Astronomy & Astrophysics Research Centre, the NRC Dominion Radio Astronomy Observatory, TRIUMF accelerator laboratory, and with industrial partners across Canada.

Currently, ARC hosts an NSERC-CREATE training program on New Technologies for Canadian Observatories, and is involved in the CFI-funded GIRMOS instrument being built at NRC-Herzberg for the Gemini-South Observatory. In addition, several members of ARC are involved in a large CFI proposal for the final design phase of a new 11-meter spectroscopic survey telescope, the Maunakea Spectroscopic Explorer.

ARC has co-hosted the [TRIUMF Summer Institute about "Modern Tools in Nuclear Astrophysics"](#) in 2017 and provided travel support for participating students.

3.3.2.2 Creation of nuclei in stars

Light element nucleosynthesis Apart from the lightest nuclei (hydrogen, helium, lithium) which are created in Big Bang nucleosynthesis, the vast majority of heavier nuclei are produced in the interior of stars (in so-called "burning phases") or through explosive stellar events. The mass of a star determines the duration and sequence of the burning phases. Stars between 0.08 and 8 solar masses (M_{\odot}) can only ignite hydrogen and helium burning and produce nuclei up to ^{12}C and ^{16}O , whereas "massive" stars with $> 8 M_{\odot}$ continue through advanced burning phases and produce a core of iron-group elements before they end their lives in Core Collapse Supernovae.

In binary systems also explosive burning phases can be triggered. For example, in "classical novae" hydrogen-rich material from a Red Giant is transferred to the surface of a dense White Dwarf and explosive hydrogen burning reactions ignited. These reactions can be detected as luminosity increase as part of the material is ejected. Another example are X-ray bursters which consist of a neutron star which is accreting hydrogen-rich material from an accompanying donor star. This material forms a dense layer due to the extremely high gravitational field. After hours of accumulation and gravitational compression, nuclear fusion starts and leads to a thermonuclear runaway. Explosive stellar nucleosynthesis is ignited via the hot CNO cycle and continues into the "rapid proton-capture (*rp*) process". The *rp*-process proceeds close to the proton-dripline up to mass $A \approx 110$. Within seconds most of the accreted material is burned, powering a bright X-ray burst that is observable with X-ray telescopes and carries information about the produced radioactive isotopes in its light curves.

All these scenarios require the accurate knowledge of proton- and α -capture reactions on stable and radioactive isotopes within the astrophysically relevant energy range ("Gamow window"). These charged-particle reaction face the challenge of Coulomb penetrability and have thus extremely small cross sections. The reactions are studied in the laboratory via direct measurements at the appropriate energies (where possible), i.e. reactants and products interacting as they do in the astrophysical environment. This requires radioactive beams like the ones produced by the ISAC facility, and the instruments optimized to study the reactions. In cases where the reaction cannot be studied directly, the approach is an indirect study, either via an appropriate nucleon transfer reaction, or extraction of nuclear parameters via scattering observables or decay properties of resonances.

Three setups at the ISAC facility at TRIUMF, namely the DRAGON and EMMA recoil separators and the TUDA detector, are well-suited for these measurements. Their broad goal is to effectively measure the cross sections of nuclear reactions using radioactive and stable beams to provide input to global nuclear reaction rate libraries. In this way they help to reduce or eliminate those reactions as sources of uncertainty between astronomical observations and astrophysical models, or elucidate their roles in the nucleosynthesis or energy generation. In addition, studies more focused on nuclear structure allow refinement of modern *ab initio* no-core shell model theory

calculations, which in turn drive theoretical extrapolations of experimental data to astrophysical energies with improving accuracy.

This measurement program is in line with the proposed aims of the γ -ray astronomy community whose recent White Paper to NASA on a new MeV-scale γ -ray mission¹⁰⁰ contained motivations for observing characteristic γ -ray lines from classical novae, as well as core-collapse supernovae.

Recent focus of the Canadian community were measurements of reactions in the region of the endpoint of nova nucleosynthesis around $A \approx 40$ since a significant disagreement between abundance predictions and spectroscopic observations of the ejecta was found. From a nuclear-physics point of view, the $^{38}\text{K}(p, \gamma)^{39}\text{Ca}$ reaction is one of the main reactions in this region for which more experiments are required. Studies exploring the sensitivity of nova nucleosynthesis to reaction rate uncertainties have found that this reaction has a strong impact on the abundances of several elements near $A = 40$ that are potentially observable in the nova ejecta, for example, ^{38}Ar , ^{39}K and ^{40}Ca . This reaction has now been measured at DRAGON and further indirect measurements in this mass region have been carried out and are under investigation, e.g. at the (now closed) Maier-Leibniz Laboratory (MLL) in Garching/ Germany and at Triangle Universities Nuclear Laboratory (TUNL). Further progress on this question must rely on improved comparisons between new spectroscopic observations of ejecta elemental abundances from this mass region, with reliable yield predictions from the models.

Another focus has been on reactions of producing and destroying radioactive ^7Be , which plays an important role for the solar neutrino production during the proton-proton chains in hydrogen burning. Recent studies of the $\alpha(^3\text{He}, ^3\text{He})\alpha$ reactions at DRAGON with the scattering chamber SONIK have provided insights into the $^3\text{He}(\alpha, \gamma)^7\text{Be}$ reaction. The $^7\text{Be}(\alpha, \gamma)^{11}\text{C}$ reaction was also investigated since it was found to play an important role in the late phase of the νp -process in core-collapse supernovae, affecting the abundances of $A = 100$ – 110 nuclei by producing intermediate-mass nuclei that remove protons from the environment (proton "poisons"). Upcoming studies will continue this program with $^7\text{Be} + \text{p}$ and $^7\text{Be} + \alpha$ elastic scattering, and in the longer term with e.g. the first precise inverse kinematics measurement of the important $^7\text{Be}(p, \gamma)^8\text{B}$ reaction.

Heavy element nucleosynthesis Nuclei beyond iron up to uranium are produced by different reactions mechanisms since nuclear fusion cannot generate energy anymore for heavier nuclei. The main processes driving the nucleosynthesis here are neutron capture processes in different astrophysical scenarios. They are distinguished by the timescale of neutron capture relative to β -decay: in the "slow" neutron capture (s) process the neutron capture is slow compared to the β -decay, thus the reaction path runs along the line of stability. The reaction flow of the "rapid" neutron capture (r) process proceeds far off stability through short-lived, neutron-rich nuclei since the neutron-capture rate is much higher than the β -decay rate. And recently, a third neutron capture process has gained a lot of attraction since it can nicely explain certain abundance pattern in stars, the so-called "intermediate" neutron capture (i) process.

For the remaining 1%, notably 32–35 neutron-deficient, stable nuclei with low elemental abundances, a superposition of charged-particle and photon-induced reaction mechanisms is summarized under the term "p processes".

All of three neutron capture processes are located on the neutron-rich side of the chart of nuclides and create the vast majority ($\approx 99\%$) of the amount of stable nuclei heavier than iron. One of the most important missing puzzle piece for all of these three neutron capture processes are experimental neutron capture cross sections on short-lived radionuclides. Whereas the cross

¹⁰⁰C. Fryer et al., *Bull. Amer. Astron. Soc.* 51, Vol. 3, 122 (2019)

sections of the vast majority of stable nuclei have been measured in the last decades and agree well with the statistical Hauser-Feshbach theory (within a factor of 2-3 at stability), this theory unfortunately cannot be reliably applied for the lightest nuclei and at neutron shell closures since the level density becomes too low. Unfortunately, the nuclei at these neutron shell closures are the most important ones in astrophysical terms since they are responsible for the formation of the observed peaks in the abundance distributions. If one moves away from stability towards more neutron-rich nuclei, the predicted rate uncertainty increases to a factor of more than 100 which would lead to large deviations in the predicted abundance. To circumvent these problems, neutron capture cross sections have to be measured for neutron-rich key nuclei.

The slow neutron-capture process The Canadian research around the s process is focused around the investigation of charged-particle reactions that influence the neutron economy. One highlight was the indirect determination of the strength of the key $E_{cm} = 706$ keV resonance in $^{22}\text{Ne}(\alpha, n)^{25}\text{Mg}$, the main neutron source for the weak s -process ¹⁰¹. In an experiment at the Texas A&M Cyclotron Institute (see Sec. 4.2.4.9) the resonance strength was determined indirectly by measuring neutron/ γ -ray decay branching ratios, following selective population of the resonance in the inverse-kinematics $^{22}\text{Ne}(^6\text{Li}, d)^{26}\text{Mg}$ reaction. The extracted strength was around a factor 3 lower than previous measurements which leads to a factor ≈ 10 –100 decrease in the production of $A > 100$ nuclides.

The rapid neutron-capture process It is not surprising that the focus of nuclear structure and astrophysics research has shifted in recent years towards the investigation of neutron-rich nuclei since the discovery potential in this “Terra Incognita” is very high. The r -process occurs in explosive astrophysical environments such as core collapse supernovae and neutron star mergers. Since its reaction path lies far from stability, many experimental campaigns world-wide are ongoing to push the known limits of neutron-rich nuclei, especially since up to ≈ 4000 more nuclei are predicted to exist and a large fraction of them will become accessible for the first time with the next generation of RIB facilities ¹⁰².

However, not all of these nuclei need to be studied for a better understanding of r -process nucleosynthesis. Sensitivity studies for different nuclear physics parameters such as masses, β -decay half-lives, neutron-capture rates, and β -delayed neutron emission probabilities have identified key regions of importance ¹⁰³. These regions are located around the $N=50$, 82, and 126 shell closures, and in the Rare Earth Element region around mass $A \approx 160$. The neutron shell closures are connected to short-lived r -process nuclei responsible for the formation of the observed elemental solar abundance peaks at $A=80$, 130, and 195. In contrast, the Rare Earth Element region is connected to nuclei with half-filled neutron- and proton orbitals that are highly deformed and produce an r -process mini-abundance peak that is responsible for the production of the stable nuclei between mass $A=160$ –170.

The lightcurve of the kilonova following the neutron star merger event that triggered GW170817 (see Sec. 1.2.4) showed two distinctive patterns: a fast, blue component high in iron-group elements and light r -process material up to $A \approx 140$, and a longer-lasting red component rich in lanthanides ¹⁰⁴. The red colour of the kilonova light curve has been interpreted to originate from the decay of

¹⁰¹S. Ota et al., Phys. Lett. B 802, 135256 (2020)

¹⁰²C.J. Horowitz et al., J. Phys. G: Nucl. Part. Physics 46, 083001 (2019)

¹⁰³M.R. Mumpower et al., Progr. Part. Nucl. Phys. 86, 86 (2016)

¹⁰⁴D. Kasen et al., Nature 551, 80 (2017)

heavy ($A > 140$) r -process material, like lanthanides ($Z=58-71$, about 1-10% of the ejected mass). This was the first direct observation of decaying lanthanides in a stellar light curve and confirmed the production in an r -process event during neutron star mergers.

There is no question that the Rare Earth Element mini-peak around $A \approx 160$ is formed when the r -process flow is hindered by nuclear structure effects in this deformed region around the neutron-midshell closure ($N=104$). However, which nuclear properties (half-lives, low-lying isomers, masses, etc.) play a key role here remains an open question due to missing experimental information.

One intermediate step to better constrain yet unknown nuclear properties like masses is the so-called "reverse-engineering" method (Sec. 3.3.2.5 and Fig. 3.23). In the case of the r -process the distinct feature of the Rare Earth Peak has been identified as perfect tool to try to extract yet-unmeasured masses, like e.g. with the Canadian Penning Trap at Argonne National Laboratory in the USA (see Sec. 3.3.3.2).

The ISAC facility at present and with the cleaner and more intense beams from ARIEL in future is ideally suited to play a key role in the exploration of hard-to-access regions. Mass measurements with the TITAN facility and decay spectroscopy with GRIFFIN and its auxiliary detectors have allowed to increase our knowledge to better understand and constrain the nuclear physics input of r -process nucleosynthesis. Offshore experiments like the campaign to measure half-lives and β -delayed neutron emission probabilities of the most neutron-rich nuclei with the BRIKEN array in Japan (see Sec. 3.3.3.2) have complemented this knowledge.

A new addition to the Canadian program are indirect measurements of neutron capture cross sections via (d, p) reactions, for example with the EMMA recoil separator coupled to TIGRESS and its auxiliary detectors. This will allow for the first time to better constrain another important nuclear physics input parameter which had so far to rely entirely on theoretical models.

The new results from PREX-II and CREX at JLab in the USA on the neutron-skin thickness will allow indirectly to constrain the density-dependence of the symmetry energy of neutron-rich nuclear matter. These results are highly anticipated in the astrophysics community due to their implications on the equation of state (EOS) and thus for the structure of neutron stars and supernovae explosions.

Experiments are always guided by theoretical predictions but in turn also help to benchmark models to make them more reliable for extrapolations into the yet-unknown regions. Going to even more neutron-rich, shorter-lived nuclei will be possible in the next decade with the new generation of radioactive beam facilities like e.g. ARIEL at TRIUMF, FRIB in the USA, and FAIR in Germany. Although not all participating neutron-rich nuclei will be accessible and should be investigated, the focus will be on the aforementioned key regions which will allow a more complete description of r -process nucleosynthesis.

The intermediate neutron-capture process A substantial fraction of so-called carbon-enhanced metal-poor (CEMP) stars have abundance distributions that cannot be described by the s - or r -processes, or by a combination of the two. The CEMP stars are "fossil" low-metallicity stars that do not yet carry the signatures of many cycles of nucleosynthesis and thus provide a unique insight into the fundamental building blocks of stellar nucleosynthesis. Recent astrophysical models and observations implied that a third neutron-capture process with "intermediate" neutron densities (10^{14} - 10^{16} n/cm^3) is responsible for these abundances. Its reaction flow proceeds through neutron-rich nuclei 2–6 neutrons away from stability where the majority of nuclear properties (masses, half-lives, β -delayed neutron emissions) are known experimentally, except for neutron capture cross sections.

The i process was first described in 1977 to occur in He-shell flashes in thermally-pulsing asymp-

otic giant branch (TP-AGB) and post-AGB stars ¹⁰⁵. Thermal convection carries hydrogen from the surrounding hydrogen-rich envelope into the helium burning shell and triggers the production of neutrons with the reaction sequence $^{12}\text{C}(p, \gamma)^{13}\text{N}(e^+\nu)^{13}\text{C}(\alpha, n)^{16}\text{O}$. Another possible astrophysical scenario are rapidly accreting white dwarfs in close binary systems ¹⁰⁶.

The main nuclear physics uncertainties in the i process comes from unmeasured neutron-capture cross sections of the participating radioactive nuclei close to stability. Direct neutron capture measurements on short-lived nuclei are not yet possible as the radioactive targets cannot be produced in the required μg quantities (corresponding to $\approx 10^{16}$ atoms) and are hard to handle due to their high activity.

A method to overcome this lack of direct neutron capture data is through (d, p) neutron-transfer reactions with accelerated radioactive beams using for example EMMA at TRIUMF-ISAC (see Sec. 3.3.3.1). In collaboration with colleagues from Norway, South Africa, and the USA a new complementary program has been initiated to study nuclei relevant to the r - and i -process at TRIUMF and other laboratories, to extract important nuclear physics parameters like nuclear level densities and γ -ray strength functions with the so-called "*Oslo-method*". These two quantities are the main sources of uncertainty in the calculation of neutron-capture cross sections within the statistical Hauser-Feshbach model. Without any experimental constraints on these parameters, theoretical predictions for cross sections of neutron-rich nuclei may vary by orders of magnitude. The proposed measurements with EMMA expect to reduce that uncertainty to a factor of 2–3.

As a first step, the $^{142}\text{Cs}(d, p)^{143}\text{Cs}$ reaction will be studied at TRIUMF to infer the (n, γ) cross section indirectly. These results will be compared with a decay experiment at Argonne National Laboratory that will constrain the neutron capture into ^{143}Cs via the " β -Oslo method" using the SuN total absorption spectrometer. The combined data will offer the first direct comparison of reaction-based and β -decay techniques for constraining neutron capture rates experimentally.

Recent i -process studies have identified four bottleneck reactions which act at different neutron densities and affect the abundance of a different element. The $^{135}\text{I}(n, \gamma)^{136}\text{I}$ reaction is important at neutron densities of order 10^{14} n/cm^3 and affects the abundance distribution of Ba. At lower densities (10^{13} n/cm^3) the Ba abundance is affected by the $^{137}\text{Cs}(n, \gamma)^{138}\text{Cs}$ reaction. On the other hand, the La abundance at low neutron densities is correlated with the $^{139}\text{Ba}(n, \gamma)^{140}\text{Ba}$ reaction, while at high neutron densities the main bottleneck is the $^{139}\text{Cs}(n, \gamma)^{140}\text{Cs}$. Accurate experimental knowledge of all four reaction rates will provide strong constraints on the predicted abundances, and in turn compare to astronomical observations and deduce the neutron densities involved in the i process.

The $^{135}\text{I}(n, \gamma)^{136}\text{I}$ reaction will be studied at Argonne National Laboratory using the β -Oslo technique and the SuN detector. The remaining three reactions will be studied at ISAC-II in 2021/22 in transfer reactions with EMMA and TIGRESS and open the door to a larger follow-up campaign towards neutron-capture cross section measurements of shorter-lived nuclei for the r -process.

3.3.2.3 Neutron star physics and the equation of state

With a radius of roughly 12 km and densities of up to twice the nuclear matter density, neutron stars are the smallest and densest objects in the universe. The behavior of matter under such extreme conditions is governed by quantum chromodynamics (QCD). Neutron stars probe the low

¹⁰⁵J.J.Cowan et al., *Astrophys. J.* 212, 149 (1977)

¹⁰⁶P.A. Denissenkov et al., *Monthly Not. Royal Astron. Soc.* 488, 4258 (2019)

temperature and high density region of the nuclear phase diagram and offer a unique opportunity to test and explore the richness of QCD in a regime that is beyond the reach of terrestrial experiments. While laboratory experiments at colliders like RHIC and the LHC explore the high-temperature/low-density regime, astrophysical studies probe the opposite, low-temperature/high-density regime.

One of the central questions in the astrophysics of neutron stars is the relation between the pressure and the density, the so-called equation of state (EOS, $P \propto \rho^\alpha$). In contrast to the EOS of white dwarfs which can be described with special relativity, the neutron star EOS needs to consider increased effects from general relativity. When translated into a mass-radius relation, neutron star mass measurements can help constraining these predictions and make better predictions of the behaviour of neutron star matter. With a "stiffer" EOS ($\alpha \geq 5/3$) a larger radius is derived for the same mass and thus a higher maximum neutron star mass.

The "neutron skin" is defined as the difference in the root-mean-square neutron and proton distributions of a nucleus, $R_n - R_p$. Precise measurements of the neutron skin thickness in neutron-rich nuclei will help to constrain the density-dependence of the symmetry energy of neutron-rich nuclear matter, which has for example implications on the structure of neutron stars and supernovae explosions.

A model-independent measurement of the neutron radius is carried out at Jefferson Lab via extraction of the parity-violating asymmetry in the elastic scattering of polarized electrons from ^{48}Ca (CREX) and ^{208}Pb (PREX-II), see Sec. 3.3.3.2. The PREX-II measurement has confirmed the large central value of the PREX I measurement ($0.33_{-0.18}^{+0.16}$ fm), with a preliminary neutron skin of 0.278 ± 0.078 fm. These results are in modest tension (just over 1σ) with the LIGO results for neutron star tidal polarizability.

A precise determination of the neutron skin in ^{208}Pb provides a constraint on the density-dependence of the symmetry energy, in a regime where extrapolation to other nuclear species and up to the scale of bulk nuclear matter (i.e. neutron stars) are possible. However, this extrapolation requires model input to describe the variation of the symmetry energy with the size and atomic mass number of the nucleus (see Fig. 3.21).

A larger neutron skin in ^{208}Pb , $R_n(^{208}\text{Pb})$, implies a stiffer EOS with a larger pressure that correlates to a larger radius of a neutron star r_{NS} . Recently there has been great progress in deducing r_{NS} from the spectrum and intensity of the X-rays emitted from neutron stars, with model-dependent corrections for the properties of the atmosphere.

However, from observations of X-ray bursts from three "ideal" neutron stars, some theories extract a very small radius of ≈ 10 km, implying that the EOS softens at high density and suggesting a transition to an exotic phase in the QCD phase diagram. Other theories using the same three neutron stars plus six more conclude that the radius is nearly 12 km, leading to a prediction of the neutron skin thickness $R_n(^{208}\text{Pb}) - R_p(^{208}\text{Pb}) = 0.15(2)$ fm. This implies a stiffer EOS which leaves little room for softening due to a phase transition at high density.

Models also claim that the neutron skin thickness of ^{208}Pb is tightly correlated with the dipole polarizability α_D and have used this to infer a new neutron skin thickness for ^{208}Pb . However, recent works have now shown that the correlations are model-dependent which emphasizes the importance of more model-independent electroweak measurements of R_n , like in the CREX and PREX-II experiments. Both experiments will provide crucial information about the neutron matter equation of state (EOS) at nuclear densities, and this data will provide a bridge between Ab-Initio calculations of medium-mass nuclei and Density Functional Theory (DFT) calculations of heavy nuclei.

The EOS of neutron stars is important for the Laser Interferometer Gravitational-Wave Ob-

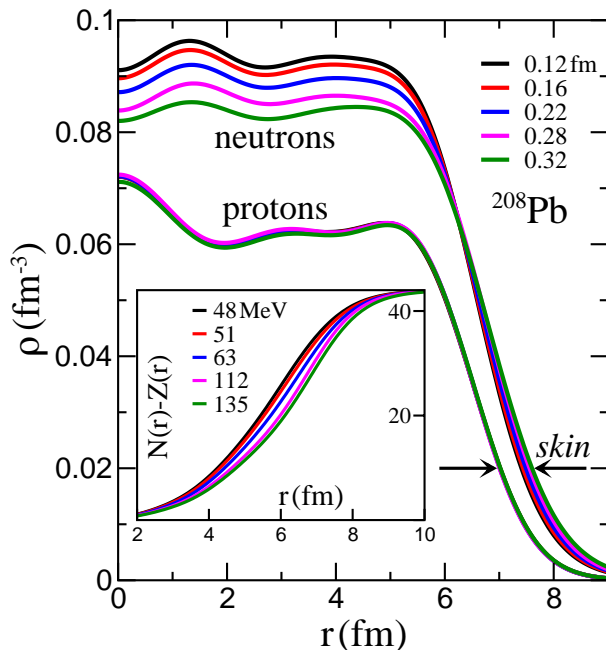

Figure 3.21: Predictions of neutron and proton densities in ^{208}Pb with differing values for the neutron-skin thickness. The inset shows the running sum of neutrons minus protons, indicating how models with larger values for the symmetry pressure L are more effective in pushing the 44 excess neutrons to the surface [J.Piekarewicz et al., *Physics Today* 72, 7, 30 (2019)]. The preliminary PREX II measurement of 0.278 ± 0.078 fm is consistent with a larger symmetry pressure, L . Figure courtesy of J. Piekarewicz (Florida State University).

servatory (LIGO) searching for signals from inspiraling neutron stars. Not only does the expected number of neutron stars observed depend upon how fast the stars cool but also the properties of the gravity waves.

3.3.2.4 Decays of nuclides under stellar conditions

Hot, dense astrophysical environments cause nuclei to be fully or highly ionized and surrounded by a cloud of free electrons (plasma). These "stellar" conditions are very different to the terrestrial conditions in the laboratory and can have a large influence on reactions (due to electron screening effects) and even decay modes (due to excited or highly-ionized states).

Some common modes of electroweak decay, such as orbital electron capture (EC), internal conversion (IC), and bound-state β -decay (β_b) proceed through an interaction between the nucleus and bound electrons within the constituent atom. As a result, the probabilities of the respective decays are not only influenced by the structure of the initial and final states in the nucleus, but can also depend strongly on the atomic charge state ¹⁰⁷.

Conditions suitable for the partial or complete ionization of nuclides can be generated artificially to selectively block or accelerate certain decay modes and thus simulate "stellar" conditions in the laboratory. The Canadian community is involved in two experiments that investigate different aspects of stellar decay modes.

¹⁰⁷Y. A. Litvinov and F. Bosch, *Rep. Progr. Phys.* 74, 016301 (2011).

In stellar environments, nuclear excitation by photoabsorption as well as via coupling to the atomic shells is possible, populating higher excited nuclear states. The two nuclear excitation mechanisms involving atomic electrons are “nuclear excitation by electron capture” (NEEC) and “nuclear excitation by electron transition” (NEET). The probability of NEET/NEEC is generally small compared with competing processes but can potentially lead to deviations from the formation paths for heavy element production processes.

When vacancies in the atomic orbitals are filled by electrons moving from higher-lying to lower-lying orbits, this energy can be emitted via X-rays or transferred to Auger electrons in outer shells. The third possibility is the NEET process that occurs by simultaneous excitation of the nucleus during an atomic transition, provided the energies of the two transitions match.

In the NEEC process a free electron is captured into a highly-charged ion with the simultaneous excitation of the nucleus, this is the time-reversal process of internal conversion (IC). The NEEC process requires that the kinetic energy of the captured free electron and its binding energy match the transition energy between two nuclear states. If the decay of long-lived nuclear isomeric states could be selectively triggered by NEEC, this method of “energy storage in isomers” has interesting implications for a next-generation of nuclear batteries.

Several nuclides with suitable transitions have been identified, and in 2018 claims of the first direct observation of the NEEC process were made in the depletion of the ^{93m}Mo isomer ¹⁰⁸. However, this was immediately followed by an intense discussion since theoretical calculations disagreed with the experimental data by ≈ 9 orders of magnitude, in clear conflict with the conclusion that NEEC was the excitation mechanism behind the observed depletion rate of ^{93m}Mo ¹⁰⁹.

At the TITAN facility at TRIUMF-ISAC the electron beam ion trap (EBIT, see Sec. 3.3.3.1) will be surrounded by up to seven photon detectors for access to in-trap decay spectroscopy of highly-charged ions. With this setup decay processes involving highly-charged ions will be investigated. In the past years the TITAN-EBIT setup has been upgraded, for example with the inclusion of a new Ultra-Low-Energy High Purity Germanium (ULE-HPGe) detector for the detection of low-energy X-ray and γ -ray transitions, as well as in collaboration with Simon Fraser University with up to five HPGe detectors from the former 8π setup. For 2021/22 the controlled measurement of the NEEC process in ^{129m}Sb is envisioned, and if successful this would be the first low-energy direct measurement.

A different approach towards the investigation of decay processes of highly-charged ions has been developed at the GSI Helmholtz Center for Heavy Ion Research in Germany, and is now used by the ILIMA (Isomers, Lifetimes, and MAsses) collaboration. This experimental program is based on the combination of the in-flight fragment separator and a system of ion storage rings that allows access to unique possibilities for the investigation of exotic decay modes, as well as the measurement of masses and half-lives of stored ions. The new Collector Ring (CR) at the Facility for Antiproton and Ion Research (FAIR) will extend this research program in the next decade.

In conjunction with resonant Schottky pickups which have single-ion sensitivity, particle detectors installed in dedicated pocket positions in the storage ring lattice, off-axis from the stored ions and separated from the ultra-high vacuum by a thin stainless steel window, can be used for identification of decay products outside of the ring acceptance as well as additional beam diagnostics.

A detector prototype, CsISiPHOS (CsI-Silicon Particle detector for Heavy ions Orbiting in Storage rings ¹¹⁰ (see Fig. 3.22), has been constructed and commissioned by the German-Canadian

¹⁰⁸C.J. Chiara et al., *Nature* 554, 216 (2018)

¹⁰⁹Y. Wu et al., *Phys. Rev. Lett.* 122, 212501 (2020)

¹¹⁰M.A. Najafi, et al., *Nucl. Instr. Meth.* A836, 1 (2016)

collaboration, and used in spring 2020 in the Experimental Storage Ring (ESR) at GSI Darmstadt to measure the half-life of the bound-state β -decay nucleus $^{205}\text{Tl}^{81+}$.

The bound-state β -decay is the time-mirrored analogue of the orbital electron capture process and occurs in fully ionized nuclei with very low Q_β value when the β electron is not emitted into the continuum but into bound states in the K and L orbitals. Whereas the half-life of the neutral atom in its ground-state can be very long-lived (^{187}Re) or even stable (^{163}Dy or ^{205}Tl , see Fig. 3.22), removal of all electrons allows for the β -decay to be accelerated by several orders of magnitude since it can now proceed by "less hindered" transitions to excited states.

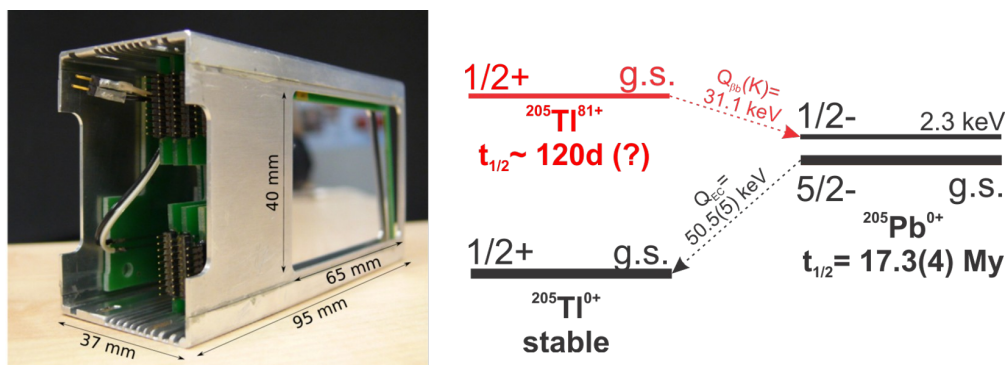

Figure 3.22: (left) Picture of the prototype detector CsISiPHOS that is presently installed at the Experimental Storage Ring (ESR) at GSI Darmstadt. (Right) The bound-state β -decay transforms stable $^{205}\text{Tl}^{0+}$ into a radioactive nucleus $^{205}\text{Tl}^{81+}$ by removing all electrons. The decay can proceed faster to the first excited state in ^{205}Pb via a first forbidden transition.

Motivation for the measurement of the decay of $^{205}\text{Tl}^{81+}$ was the LOREX (LORandite EXperiment) solar neutrino experiment ^{111, 112}, which is one of the biggest geochemical activation experiments on Earth and designed to measure the solar neutrino flux integrated over the last few million years. LOREX uses lorandite, a Tl-bearing mineral (TlAsS_2) from the Allchar mine (Macedonia) and measures the ^{205}Pb content produced from neutrino capture on ^{205}Tl . The solar proton-proton neutrino flux can be measured over the period of 4.3 million years from the reaction $^{205}\text{Tl} + \nu_e \rightarrow ^{205}\text{Pb} + e^-$ with a very low threshold of 52 keV, the lowest of any known neutrino-induced nuclear reaction. The measurement of the bound-state β -decay probability of $^{205}\text{Tl}^{81+}$ (see Fig. 3.22) is one important, yet unknown input parameter for the determination of the "true" mean solar pp-neutrino flux. Theoretical calculations estimate this half-life to be in the order of $t_{1/2} \approx 120$ days.

The latest ESR experiment has now, for the first time, measured this half-life. This data is presently analyzed by students at GSI and at TRIUMF. In parallel, NSERC funding for a second in-ring particle detector has been received, and the construction is ongoing (see Sec. 3.3.3.2)

3.3.2.5 Theoretical nuclear astrophysics efforts

The theoretical nuclear (astro)physics efforts in Canada are focused in the two groups at TRIUMF and at the University of Guelph. With now two principal investigators the nuclear theory group in Guelph is starting to form a hub, aiming to provide answers to overarching questions related

¹¹¹K.M. Subotic et al., AIP Conf. Proc. 455, 912 (1998)

¹¹²M.K. Pavicevic, Nucl. Inst. Meth. A 895 (2018) 62

to nuclear forces, novel states in nuclei and matter, as well as the behaviour of matter at thermodynamic extremes found in neutron stars, their mergers, accretion disks around black holes, and supernovae. At TRIUMF, the focus is on *ab-initio* methods for light and medium-mass nuclei...

A detailed description of their methods can be found in Secs. 3.2.2.1 and 3.5. In this section applications of these methods for nuclear astrophysics are described.

Astrophysical Signatures Guelph, TRIUMF; Colombia, USA

A detailed description of the work can be found in Sec. 3.5.2.5. The aim is to build a consistent theoretical framework with key physics from nuclear physics, neutrino reactions, and gravity to predict multi-messenger observations, for example elemental abundances and neutrino fluxes. This can be achieved with a coherent understanding of the different emission channels of compact objects like Neutron Stars and Black Holes, their mergers and accretion into them. This research is timely, given the recent successful debut of the multi-messenger era triggered by GW170817 (see Sec. 1.2.4).

These results from these astrophysical calculations will help constrain nuclear interactions and the nuclear matter EOS, offer limits on the detection of neutrinos in the Galaxy and at cosmological distances, and provide input to numerical relativity simulations and experimental searches.

The research is building on previous work, e.g. for the role of the black hole spin on the observer's inclination for distant black hole accretion disks¹¹³ and detection of the relic neutrino background from accretion disks around black holes¹¹⁴.

For accreting neutron stars the group has made progress on the understanding of the impact of degeneracy on neutron capture rates in accreting neutron stars¹¹⁵. The research in the next years aims to study neutrino emission properties in curved space-time, to quantify directionality effects of relativistic neutrino absorption on the proton-fraction of outflows and *r*-process nucleosynthesis, as well as to study the effect of gravity on neutrino oscillations for accretion disks and mergers.

Nuclear Many-Body Problem Guelph, TRIUMF; Germany, USA

A detailed description of the work can be found in Sec. 3.5.2.5.

This research studies the connections between microscopic nuclear interactions and strongly interacting nuclear systems appearing in terrestrial laboratories and in astrophysical settings. Improved formulations of nuclear forces are used to understand the physics of neutron star crusts and cores, neutron-rich nuclei, as well as phenomena at the interface of nuclear physics and ultracold atoms. The research employs chiral Effective Field Theory (χ EFT) interactions, which are then used in different few- and many-nucleon frameworks. The work on nucleonic matter studies is complementary to the research carried out at the TRIUMF Theory Group.

Recent research results include the use of local chiral EFT in light nuclei and neutron matter¹¹⁶, novel developments in first-principles or mean-field techniques¹¹⁷, and the use of ab-initio methods to constrain selected aspects of more phenomenological approaches^{118 119}.

In the upcoming years, the research program will employ a mixture of pionless and chiral EFT interactions, applied to light or medium-mass nuclei as well as nucleonic matter in the context of

¹¹³O.L. Caballero et al, Phys. Rev. D 93, 123015 (2016)

¹¹⁴T.S.H. Schilbach et al., Phys. Rev. D 100, 043008 (2019)

¹¹⁵B. Knight and L. Caballero, Universe 5(1), 36 (2019)

¹¹⁶J. Lynn et al, Phys. Rev. Lett. 116, 062501 (2016)

¹¹⁷E. Rrapaj et al, Phys. Rev. C 99, 014321 (2019)

¹¹⁸M. Buraczynski and A. Gezerlis, Phys. Rev. Lett. 116, 152501 (2016)

¹¹⁹M. Buraczynski et al., Phys. Rev. Lett. 122, 152701 (2019)

quantum Monte Carlo simulations. On the phenomenological front, a quasi-3D Skyrme-Hartree-Fock self-consistent solver is being finalized, which has been already applied to the problem of the static response of neutron matter. In addition, the future research will employ neural networks to understand the approach to the thermodynamic limit and to produce improved variational wave functions for strongly correlated systems.

Ab-Initio Methods for light and medium-mass nuclei: NCSMC TRIUMF; USA, Germany

A detailed description of the work can be found in Sec. 3.5.2.6. The implications of this work for Nuclear Structure can be found in Sec. 3.2.2.1.

The exact treatment of nuclei starting from the constituent nucleons and the inter-nucleon interactions among them has been a long-standing goal in nuclear physics. The goal of this research is to develop a predictive *ab-initio* theory of nuclear structure and nuclear reactions for light and medium mass nuclei. Such a theory is needed for the understanding of exotic nuclei investigated at rare isotope facilities, for nuclear reactions important for astrophysics, for fusion reactions for the future energy generation as well as for the testing of fundamental symmetries in nuclear processes.

In addition, an accurate many-body theory for light and medium mass nuclei provides a feedback about the quality of the inter-nucleon interactions, e.g. those derived from the QCD-based chiral effective field theory (χ EFT), used in the calculations and ultimately helps to improve our knowledge of the nucleon-nucleon (NN) interaction, and in particular of the still-not-completely-understood three-nucleon (3N) interaction.

The method primarily used in this project is the no-core shell model with continuum (NCSMC). For example the ${}^3\text{He}(\alpha, \gamma){}^7\text{Be}$ radiative capture, one of the key reactions for Big-Bang nucleosynthesis and the solar proton-proton chain has been described successfully with this method ¹²⁰.

The medium-term goals include investigations of reactions important for astrophysics, including radiative capture reactions such as (n, γ) , (p, γ) , (α, γ) as well as charge-exchange and transfer reactions involving α -particles. Prominent examples for future research are ${}^8\text{Be}(\alpha, \gamma){}^{12}\text{C}$ and ${}^{12}\text{C}(\alpha, \gamma){}^{16}\text{O}$ for helium-burning processes, and reactions like ${}^{14}\text{N}(n, p){}^{14}\text{C}$ and ${}^{13}\text{C}(\alpha, n){}^{16}\text{O}$ that are relevant for the neutron production and destruction in the intermediate (*i*) and slow neutron capture (*s*) processes.

Ab-Initio Methods for heavy nuclei: VS-IMSRG TRIUMF; USA, Germany

A detailed description of the work can be found in Sec. 3.5.2.6. The implications of this work for Nuclear Structure can be found in Sec. 3.2.2.1.

The central focus of this project is to quickly advance a novel many-body approach, the valence-space formulation of the in-medium similarity renormalization group (VS-IMSRG), which can be thought of as an *ab-initio* shell model approach to atoms and nuclei, using the latest two (NN) and three nucleon forces (3N) developed by the community.

The VS-IMSRG method allows to calculate properties of light to heavy nuclei starting from only input nuclear forces and electroweak currents. A tremendous level of progress has been made in the past few years in the development of this method into a world-leading and far-reaching *ab-initio* tool. With the excellent agreement with data in terms of absolute and separation energies, first global *ab-initio* calculations of all nuclei from helium to nickel were performed and achieved deviation from absolute experimental ground-state energies on a level that is comparable with nuclear mass models.

¹²⁰J. Dohet-Eraly et al., Phys. Lett. B 757, 430 (2016)

A topic of indirect nuclear astrophysics interest are WIMP-nucleus structure functions for dark matter direct detection searches. The group has now implemented these processes into the VS-IMSRG framework and has calculated up to Ge. The goal is to provide first *ab-initio* WIMP-nucleus scattering cross sections for all direct detection candidates up to Xe.

The medium-term goals of the VS-IMSRG are to expand the reach towards heavier nuclei and towards the driplines, and to predict the neutron skin thickness of ^{208}Pb (see PREX-II experiment, Sec. 3.3.3.2). This will also include the investigation of the structure of exotic nuclei and the evolution of magic numbers to the heavy region of nuclei.

Reverse engineering of r -process abundances TRIUMF, UBC; Manitoba, McGill; USA

One of the most useful theoretical tools to guide experimental efforts nowadays are so-called “sensitivity studies” in which one or more nuclear parameter is varied within given boundaries, e.g. nuclear masses within ± 500 keV or cross sections by a factor of 10, and the resulting influence on the calculated isotopic abundances investigated with astrophysical reaction networks. This procedure helps to identify “sensitive” nuclear physics inputs and key areas for further investigations.

So far, these sensitivity studies were only a one-way street and helped to identify key nuclei for more detailed studies. A new tool that has now become possible thanks to machine learning tools and high performance computing is the so-called “reverse engineering”¹²¹ where an astrophysical reaction network is repeatedly solved and compared against the observed r -process abundances to optimize and constrain the input parameters (e.g. unknown nuclear properties, astrophysical conditions, initial composition, expansion timescales etc.) with Markov-chain Monte Carlo (MCMC) methods (see Fig. 3.23).

This method has been successfully applied for masses of neutron-rich nuclei in the so-called “Rare Earth Region” ($A=160-170$). Mass measurements of neutron-rich neodymium ($Z=60$) and samarium ($Z=62$) were carried out at the Canadian Penning Trap (CPT) at Argonne National Laboratory (see Sec. 3.3.3.2) and were compared with predictions from “reverse engineering” of the elaborately parameterized mass surface that best reproduces the solar abundances of the stable lanthanide nuclei¹²². In this way a new semi-empirical mass surface can be extracted that sets constraints on yet unmeasured heavier isotopes.

An extension to this “reverse engineering” is presently developed by TRIUMF/ UBC scientists in collaboration with astrophysicists at Los Alamos National Laboratory and the University of Notre Dame in the USA. The idea is to improve and generalize the reverse engineering method by replacing the computationally expensive reaction network simulations with much faster neural network “emulators” that will then allow not only for more robust Bayesian parameter inference thanks to the faster accumulation of data points in MCMC methods, but also allows to apply this method in a variety of mass ranges and nuclear parameters in addition to masses. To achieve this, there are two important steps to add: First, a “good” emulator has to be developed via training of machine learning algorithms; then the next step is to sample from the posterior distributions of the parameters, which may be reduced or compressed by a “dimensionality reduction” technique, through an MCMC algorithm coupled to the emulator. Both steps have to be carried out without losing any important information, for example the prominent even-odd staggering in masses or structure changes around (sub-)shell closures.

These methods cannot replace the respective measurement if this nuclei becomes accessible but help to put tighter constraints on parameter ranges for theoretical models which will stay

¹²¹M. Mumpower et al., J. Phys. G: Nucl. Part. Phys. 44, 034003 (2017)

¹²²R. Orford et al., Phys. Rev. Lett. 120, 262702 (2018)

invaluable for the vast majority of nuclear physics properties which cannot be measured with the next generation of radioactive beam facilities.

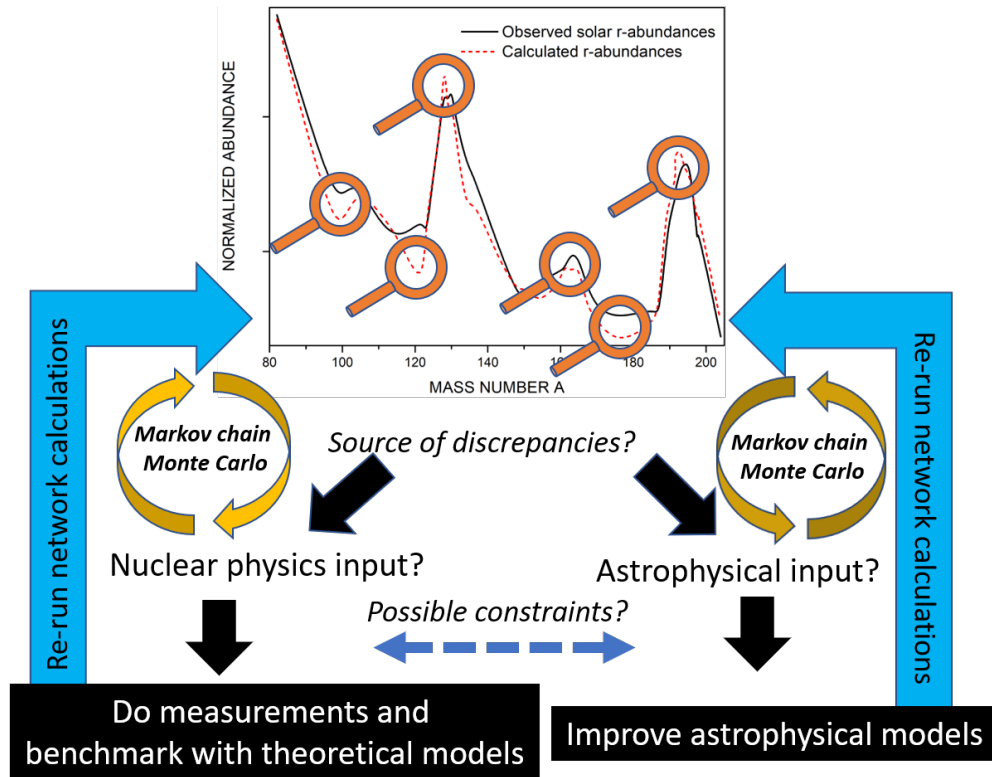

Figure 3.23: Example of "reverse engineering" in nuclear astrophysics: By comparison of the measured (observed) r-process abundances with the abundances from astrophysical reaction network calculations regions of discrepancies can be identified which require further finetuning of the astrophysical or nuclear physics inputs. MCMC techniques can be used to automatize the search for the "best" input parameters and set constraints yet unmeasured properties.

3.3.3 Experimental Facilities

Whereas the domestic experimental Nuclear Astrophysics research program is centered at the ISAC (Isotope Separator and Accelerator) facility at TRIUMF, a diverse offshore program is ongoing at various stable and radioactive beam facilities in Germany, Japan, and the USA.

3.3.3.1 Experiments at the ISAC facilities at TRIUMF

DRAGON recoil separator (TRIUMF) McMaster, Northern British Columbia, Simon Fraser, St. Mary's; UK, USA

DRAGON (Detector of Recoils And Gammas Of Nuclear reactions) is a recoil separator based around a windowless recirculating (hydrogen or helium) gas target which is designed to measure astrophysically important radiative (α and proton) capture rates of stable and radioactive beams. Of particular interest are the reactions which occur in the asymptotic giant branch (AGB) stars, or in explosive environments like classical novae, supernovae, and X-ray bursters.

The success of DRAGON lies in its ion-optical design, providing it with superior background rejection qualities which allow measurements to be made with a range of beam intensities. Surrounding the gas target is a high-efficiency bismuth germanate (BGO) array to detect γ 's emitted by radiative capture reactions. Thanks to its world-leading beam suppression (up to 10^{13}) and its excellent mass resolving power, detection of recoiling fusion products at the focal plane is possible down to 1 event per week, which allows to measure astrophysically important cross sections on stable nuclei that are otherwise only accessible in deep underground laboratories, or for radioactive nuclei that are accessible nowhere else.

DRAGON has been extremely successful in measuring challenging radiative capture reactions with radioactive beams, which suffer from high background and low count rates. It has performed the majority of these pioneering measurements where the reaction is measured for the first time directly, e.g. $^{19}\text{Ne}(p, \gamma)^{20}\text{Na}$ (Ref. [123](#)) and $^{38}\text{K}(p, \gamma)^{39}\text{Ca}$ (Ref. [124](#)).

DRAGON can also be set up with the scattering chamber SONIK (Scattering Of Nuclei in Inverse Kinematics, see Fig. [3.24](#)) which utilizes the windowless gas target to induce scattering, with ejectiles or/and recoils detected at precise angles, simultaneously at different interaction energies. With high intensity radioactive and stable beams, these data are used to measure low-energy elastic scattering differential cross sections, which aid in the extrapolation of capture data to the very lowest astrophysical energies. Recent studies of $\alpha(^3\text{He}, ^3\text{He})\alpha$ have provided insights into the $^3\text{He}(\alpha, \gamma)^7\text{Be}$ reaction; the system will soon be used to study both $^7\text{Be}+p$ and $^7\text{Be}+\alpha$ elastic scattering, and in the longer term other light radioactive beams.



Figure 3.24: The new scattering chamber SONIK which can be set-up around the windowless gas target at DRAGON. (Picture: 2018 TRIUMF Photowalk; Sarah Johnson)

The plans for the near future include the installation of GRIFFIN clovers around the gas target for a more sensitive γ -tagging of capture reactions. A CFI application is also prepared for a new,

¹²³R. Wilkinson et al., Phys. Rev. Lett. 119, 242701 (2017)

¹²⁴G. Lotay et al., Phys. Rev. Lett. 116, 132701 (2016), G. Christian et al., Phys. Rev. C 97, 025802 (2018)

highly efficient LaBr₃ array surrounding the gas target. This would allow a sensitivity increase of a factor of ≈ 10 .

EMMA recoil spectrometer (TRIUMF) Guelph, McMaster, Saint Mary's, SFU

The experimental setup and the nuclear structure program of EMMA is discussed in Sec. 3.2.3.1.

The Electromagnetic Mass Analyser (EMMA) is a recently-commissioned vacuum-mode recoil mass spectrometer located in the ISAC-II experimental hall. EMMA's design enables the measurement of fusion evaporation, radiative capture, and transfer reactions for nuclear structure and astrophysics. Currently, the TIGRESS spectrometer is situated at the EMMA target location, as shown in Fig. 3.18.

EMMA is able to perform high-mass radiative capture reactions that are out of reach of the DRAGON facility. The first scientific experiment in 2019 was a measurement of the cross section of the $p(^{83}\text{Rb},\gamma)^{84}\text{Sr}$ reaction, carried out in conjunction with the TIGRESS γ -ray spectrometer. That study represented the first ever direct measurement of a supernova reaction using a radioactive beam, providing valuable information for models of the astrophysical p process.

EMMA will extend its experimental program in the upcoming years with TIGRESS and auxiliary detectors like SHARC-II and TI-STAR to indirectly constrain neutron capture cross sections of radioactive nuclei. In particular, (d, p) reactions such as $^{87}\text{Kr}(d, p)^{88}\text{Kr}$ and $^{142}\text{Cs}(d, p)^{143}\text{Cs}$ will be studied to infer the (n, γ) reaction cross section indirectly. In these reactions the "Oslo method" will be applied to extract the nuclear level density (NLD) and the γ -ray strength function (γSF) which are important ingredients to constrain the neutron capture cross section.

GRIFFIN and auxiliary detectors (TRIUMF) Guelph, SFU, Regina, Queen's; USA

For a detailed description of the array and its auxiliary detectors, see Sec. 3.2.3.1. Since its commissioning in 2016 the GRIFFIN spectrometer with its many auxiliary detectors has been proven as powerful device for the spectroscopy of neutron-rich nuclei. In combination with the excellent beam purity achieved with the ion-guide laser ion source (IG-LIS)¹²⁵ and uranium carbide targets, one region of increased interest for recent decay spectroscopy with GRIFFIN has been the cadmium and indium nuclei around doubly-magic ($Z=50, N=82$) ^{132}Sn . The first physics result from the new GRIFFIN spectrometer¹²⁶ resolved a stunning 23% discrepancy between two previous half-life measurements for the important $N=82$ r -process nucleus ^{130}Cd , which is mainly responsible for the second abundance peak at $A=130$.

However, this shift in the adopted ^{130}Cd half-life to much lower values posed then a problem for shell-model calculations, which used the half-lives of ^{131}In and ^{130}Cd as "anchor points" to extract half-lives for the (at that time) unknown half-lives of $N=82$ isotones with $Z < 47$. A renormalization to the new ^{130}Cd half-life (corresponding to a reduced quenching of the Gamow-Teller transition strength) resulted in an almost perfect reproduction of recently measured half-lives – with the exception of ^{131}In . A follow-up experiment of the β - and β -delayed neutron decay of ^{131}In was performed¹²⁷ and greatly extended the known decay scheme. With this, a better understanding of the important first-forbidden contributions to the β -decay strength was achieved that will allow more reliable shell model calculations in this crucial region for r -process nucleosynthesis.

Along the same line, detailed spectroscopic investigations of the decays of the ground and

¹²⁵S. Raeder et al., Rev. Sci. Instrum. 85, 033309 (2014)

¹²⁶R. Dunlop et al., Phys. Rev. C 93, 062801(R) (2016)

¹²⁷R. Dunlop et al., Phys. Rev. C 99, 045805 (2019)

isomeric states of ^{129}Cd (Ref. [128](#)) also greatly extended the known decay scheme and even surpassed a recent study by the former EURICA setup at RIKEN Nishina Center [129](#). The $\log ft$ values deduced from the β -feeding intensities suggest that some of the high-lying states in ^{129}In are populated by the $\nu 0g_{7/2} \rightarrow \pi 0g_{9/2}$ allowed Gamow-Teller transition, which indicates that this transition is more dominant in ^{129}Cd decay than previously thought. In addition, a previous discrepancy between the half-lives of the $11/2^-$ ground-state and the $3/2^+$ isomeric state was resolved.

A future focus for spectroscopic investigations with GRIFFIN will be the neutron-rich rare earth region near the midshell closure at ^{170}Dy ($Z = 66$, $N = 104$). The development of heavier lanthanide beams is a unique strength of the ISAC facility since yields from fission sources drop quickly towards heavier masses. Also beams from the ARIEL photofission target from Day 1 of its operation will allow to push the decay spectroscopy program to even further neutron-rich nuclei.

DESCANT, the DEuterated SCintillator Array for Neutron Tagging, is a 70-element array of deuterated liquid-scintillator detectors that can be used with both the TIGRESS and GRIFFIN. After several commissioning runs it will be used as neutron tagger for the spectroscopy of very neutron-rich nuclei that decay by β -delayed neutron emission. For more details, see Sec. [3.2.3.1](#).

IRIS (TRIUMF) Guelph, McMaster, Regina, Saint Mary's, SFU; Japan, UK, USA, France
 The ISAC Reaction Induced Spectroscopy station (IRIS) is a facility to study direct reactions by charged-particle spectroscopy using the reaccelerated beams of radioactive isotopes with energies from 5–12 A MeV provided by the ISAC-II facility at TRIUMF. It utilizes nucleon transfer reactions, inelastic, and elastic scattering on a thin windowless solid H_2 or D_2 target to investigate light nuclei around the proton- and neutron drip-lines to study nuclear shell structure, new excitation modes, exotic halos and skins, and nucleosynthesis processes.

After a very successful past campaign (for more details, see Sec. [3.2.3.1](#)) the focus in the upcoming years will be the coupling to an active target time projection chamber (TPC) in which the detector gas also acts as the reaction target allowing tracking and detection of very low-energy reaction products. An experimental campaign with an active target TPC from collaborators in France (ACTAR, see Fig. [3.25](#)) is planned for the near future, and a CFI funding proposal for the construction of a new active target TPC (EXACT-TPC) is presently underway. Another future project is the coupling of neutron detectors (Sec. [3.3.3.2](#)) to IRIS for studying (d, n) reactions.

Extension of the experimental program from light to medium-mass to neutron-rich Ca, Ga, and Kr isotopes is planned. These projects will use inelastic deuteron and proton scattering, one and two-nucleon transfer reactions mainly with deuteron and proton targets. First exploratory studies of a (d, p) reaction on neutron-rich ^{93}Kr were performed with a low beam intensity of 200 pps, which is an unprecedented accomplishment.

TIGRESS and auxiliary detectors (TRIUMF) Guelph, SFU, Saint Mary's; France, Spain, UK, USA

As in the case of GRIFFIN, the sensitivity of TIGRESS γ -spectrometer is dramatically enhanced through its coupling with a suite of specialized charged-particle and neutron detector systems that can be tailored, for each experiment, to the reaction of interest. For details of the setups and the nuclear structure program, see Sec. [3.2.3.1](#).

¹²⁸Y. Saito et al., Phys. Rev. C 102, 024337 (2020)

¹²⁹J. Taprogge et al., Phys. Rev. C 91, 054324 (2015)

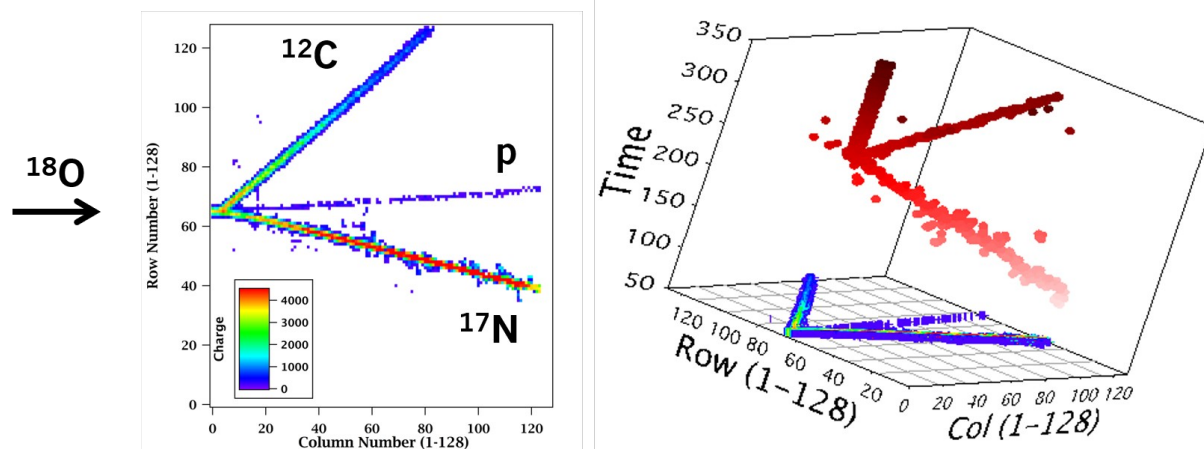

Figure 3.25: Observed particle tracks of a reaction detected in the ACTAR active target time projection chamber. Picture by G. Grinyer (U Regina).

Two of the main auxiliary detectors for the measurement of astrophysically relevant transfer reactions are SHARC (Silicon Highly-segmented Array for Reactions and Coulex) and TI-STAR (TIGRESS Silicon Tracker Array) which is presently under development. Recently, TIGRESS has been coupled with the EMMA recoil spectrometer (see Sec. 3.3.3.1 and 3.2.3.1 for details about this program).

SHARC is comprised of up to 2000 channels of double-sided silicon strip detectors (DSSDs) with nearly 4π solid angle coverage around the reaction target at the centre of the TIGRESS array, developed by collaborators from the University of York in the UK and optimized for light charged particle detection in single- and two-nucleon transfer reactions with accelerated radioactive ion beams in inverse kinematics. It is used to detect charged particles with excellent energy and angular resolution. An upgraded version of SHARC is presently being built and will be ready to use in early 2021. The new SHARC-II vacuum enclosure will permit the simultaneous use of SHARC, TIGRESS, and EMMA for the first time, including DSSD coverage at both large and small laboratory scattering angles without diminishing the angular acceptance of EMMA.

Stable ^{19}F is thought to be produced in asymptotic giant branch (AGB) stars via the reaction sequence $^{18}\text{O}(p, \alpha)^{15}\text{N}(\alpha, \gamma)^{19}\text{F}$. At present, however there are inconsistencies between the observed abundances and the modelled ones. Other astrophysical scenarios might also contribute to the ^{19}F abundances but are lacking firm observations. It is thus thought that the underproduction is due to uncertainties in reaction rates, including the competing $^{18}\text{O}(\alpha, \gamma)^{22}\text{Ne}$ reaction. The resonance properties in ^{22}Ne were studied following a one-neutron transfer experiment in inverse kinematics using TIGRESS and SHARC to identify the spins of critical resonances which dominates the α capture rate into ^{22}Ne around 0.1 GK. With this data the production of ^{19}F can now further be constrained.

TI-STAR is being developed at the University of Guelph and will precisely reconstruct the vertex of nuclear reactions in an extended gas target, providing a new capability to study transfer reactions with TIGRESS using accelerated radioactive beams from ISAC-II. TI-STAR makes use of multiple layers of novel ultra thin silicon detectors of $20\mu\text{m}$ thickness to track light recoils like protons and helium ions. The current schedule foresees TI-STAR to be operational in fall 2021/spring 2022 for

CANREB experiments at TRIUMF.

A major goal of the TI-STAR project is constraining neutron capture rates for *i*-process and *r*-process nuclei via one-neutron transfer reactions, for which a new program has been initiated at TRIUMF. For this, TI-STAR will include an extended deuterium target that, when combined with its high resolution tracking capability to reconstruct the interaction point, will provide excellent energy resolution, while enhancing the reaction yield by factors of 10–100 for Oslo-type measurements. Simulations show that TI-STAR will give access to neutron capture rate measurements for a large number of important nuclei determining the final *r*-process abundances.

This new program will greatly benefit from the new ARIEL facility (Sec. 4.1.1.3) since it will give access to clean and intense radioactive beams for studies in the *i*-process and *r*-process region.

TITAN ion trapping facility (TRIUMF) Calgary, Manitoba, McGill, SFU; France, Germany, Netherlands, South Korea, UK, USA

TITAN (TRIUMF’s Ion Trap for Atomic and Nuclear science) is a unique ion trap facility, currently consisting of five individual ion traps coupled together. For technical details, see Sec. 3.2.3.1. It is a facility that is ideally suited for high-precision measurements of very short-lived nuclei down to a few ms half-lives since it has the fastest beam preparation and measurement cycle for on-line precision mass measurements and is the only system in the world to provide highly charged radioactive ions, which boost the precision by one to two orders of magnitude. The astrophysics part of the TITAN research program has been focussed on mass measurements for the *r*- and *rp*-process. The commissioning of the Multi-Reflection Time-of-Flight (MR-TOF) spectrometer in 2017 has extended TITAN’s capabilities and marked a new era, especially for mass measurements with astrophysical background.

Another new direction at TITAN is the In-Trap Decay Spectroscopy program investigating decay modes of highly-charged ions that cannot be measured anywhere else (see Sec. 3.3.2.4). TITAN is currently the only ion trap facility in the world capable of performing decay-spectroscopy on trapped highly charged radioactive ions (HCIs). This work employs the radio-frequency quadrupole (RFQ) linear Paul trap, used to cool and bunch the ISAC beam, and the electron-beam ion trap (EBIT) for increasing the atomic charge-state of the ions and performing the in-trap decay measurements¹³⁰. The TITAN-EBIT features seven ports with optical access to the center of the trap, which are able to house various photon detectors (see Fig. 3.26). For this future decay spectroscopy program detectors from the former 8π setup will be used which are provided in collaboration with Simon Fraser University. The setup will be fully operational in 2021 and will allow to start a new experimental campaign for the controlled measurements of nuclear excitation via electron capture (NEEC) (e.g. in ^{129m}Sb), and selective decay-mode blocking of first-order atomic and nuclear transitions.

Medium-term upgrades of the TITAN facilities include a cryogenically cooled Penning trap (cryoMPET) using two detection techniques, namely the Time-Of-Flight (TOF) and Phase-Imaging Ion-Cyclotron-Resonance (PI-ICR) techniques. The latter can improve the precision, resolving power, and sensitivity of the former, and the precision of both techniques benefits from higher charge states.

TUDA particle detector (TRIUMF) McMaster, Northern British Columbia, Simon Fraser; UK

¹³⁰K.G. Leach et al., Nucl. Instr. Meth. A 780, 91 (2015).

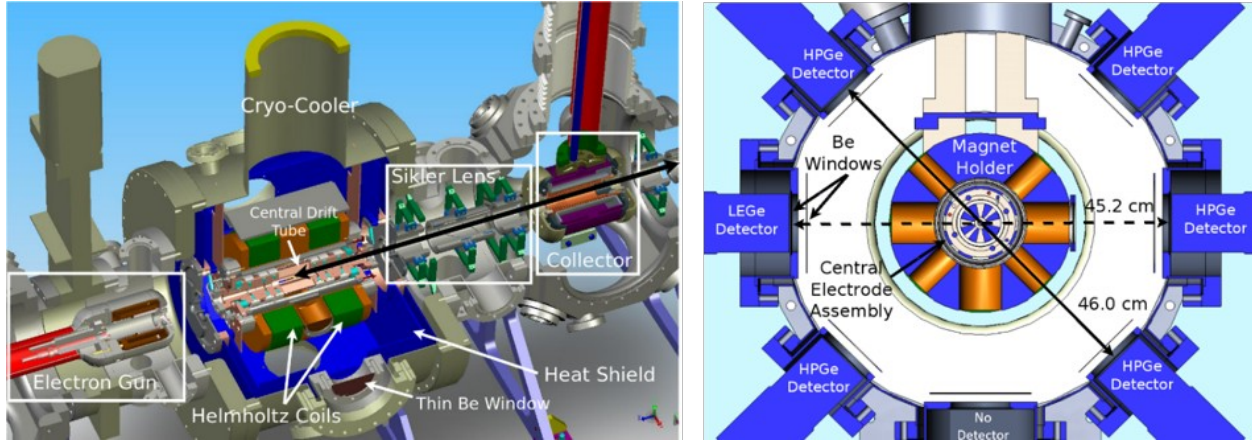

Figure 3.26: (Left) A schematic view of the TITAN electron beam ion trap (EBIT). (Right) Cross-sectional view of the EBIT configuration for decay spectroscopy demonstrating the access ports where HPGe detectors are located. Figures are adapted from K.G. Leach et al., Nucl. Instr. Meth. A780, 91 (2015).

The TUDA (TRIUMF-UK Detector Array) charged-particle scattering and reaction detector array is a collaboration with the University of Edinburgh and the University of York in the UK. It is a versatile scattering facility based around large area, highly-segmented silicon arrays and a variety of solid or gaseous targets. TUDA is a portable detector which can be installed in both ISAC experimental halls to indirectly constrain reaction rates or to provide important nuclear structure information (e.g. excitation energies, spins, and parities) to guide direct measurements. It is especially well-suited for transfer reactions, elastic scattering, and direct measurements of (p, α) and (α, p) reactions. These reactions address problems in massive star nucleosynthesis, thermonuclear and core-collapse supernovae, and classical novae.

It has provided a variety of data on astrophysical reactions over the years, most recently for the $^{18}\text{F}(p, \alpha)^{15}\text{O}$, $^{18}\text{Ne}(\alpha, p)^{21}\text{Na}$, $^{26}\text{Al}(d, p)^{27}\text{Al}$ and $^{23}\text{Na}(\alpha, p)^{26}\text{Mg}$ reactions.

3.3.3.2 Offshore experiments

Canadian scientists are involved in astrophysics experiments with the main focus on the complementary program at large in-flight fragmentation facilities like the GSI Helmholtz Center and FAIR in Germany, RIKEN Nishina Center in Japan, and NSCL/ FRIB in the USA. In addition, a diverse research program with stable and radioactive beams is also carried out at various smaller accelerator facilities worldwide.

Nuclear radii measurements (GSI/ Germany, RIKEN/ Japan) Saint Mary's, TRIUMF; China, Germany, Japan, the Netherlands, Slovakia, Spain, UK, USA

The research program at the Fragment Separator (FRS) at GSI Darmstadt and the RIKEN Nishina Center at RIKEN, Japan uses the reactions of high-energy beams of exotic nuclei on various targets to determine the neutron skin thickness and discover nuclear halos through measurement of their nuclear radii. This research seeks to unveil exotic nuclear forms, neutron halos, neutron skin and new arrangements of nuclear shells in nuclei approaching the edges of the bound nuclear landscape. The thick neutron-dominated surface emerging in these nuclei provides laboratory

access to gain knowledge on the equation-of-state of asymmetric nuclear matter that describes the characteristics of neutron-rich cosmic environments such as neutron stars and supernovae. For more details, see Sec. 3.2.3.2.

Spectroscopy of highly-charged ions in storage rings (GSI/FAIR) TRIUMF; China, Germany, Japan, UK

The Canadian research program at the storage rings at GSI/FAIR in Darmstadt/ Germany is part of the ILIMA (Isomers, Lifetimes, and MAsses) collaboration. In conjunction with conventional resonant Schottky pickups, particle detectors are installed in dedicated pocket positions in the storage rings and can be used for identification of decay products outside of the ring acceptance as well as additional beam diagnostics. This setup allows unique investigations of exotic decay modes of highly-charged ions over several hours (compared to tens of seconds in trap-environments like in the TITAN-EBIT), as well as the parallel (symbiotic) measurement of masses and half-lives of stored ions.

A multi-purpose particle detector prototype, CsISiPHOS (CsI-Silicon Particle detector for Heavy ions Orbiting in Storage rings, see Fig. 3.22), has been constructed and commissioned, and used in spring 2020 in the Experimental Storage Ring (ESR) at GSI Darmstadt to measure half-life of the bound-state β -decay nucleus $^{205}\text{Tl}^{81+}$ (see Sec. 3.3.2.4).

NSERC funding was awarded in 2020 to construct an advanced version of the CsISiPHOS particle detector, as well as to upgrade the data acquisition system for operation at FAIR. The design of the new detector is the result of an extensive R&D program performed in collaboration with the TU Munich/ Germany that resulted in a FAIR Technical Design Report (TDR) ¹³¹. The new particle detector stack is presently under construction at TRIUMF and will be installed and tested at GSI Darmstadt in late 2021. With this second particle detector, e.g. symbiotic measurements of masses, half-lives, and neutron-branching ratios are envisioned in the next decade with FAIR.

Measurements of β -delayed neutron emitters with BRIKEN (RIKEN) TRIUMF, McMaster; Chile, Hong Kong, Japan, Poland, Spain, UK, USA, Vietnam

The BRIKEN (Beta-delayed neutron emitters at RIKEN) collaboration (Fig. 3.27) has the goal of measuring half-lives and neutron-branching ratios of ≈ 600 β -delayed neutron-emitters for direct input into astrophysical models for a better understanding of the nucleosynthesis of heavy elements in the r -process. The setup consists of an implantation detector with double-sided silicon strip detectors (DSSDs), a moderated neutron detector with 140 ^3He -filled tubes, and two optional HPGe clover detectors ¹³². In three years of running between 2016-18, more than 270 nuclei have been investigated between ^{33}Na and ^{170}Gd , and ≈ 180 new neutron-branching ratios and ≈ 60 new half-lives have been extracted. First results have now been published (see Refs. ¹³³, ¹³⁴, and ¹³⁵) and many more papers will follow. Two of the six experimental campaigns were lead by Canadian researchers.

The BRIKEN campaign will conclude in 2021, and the Canadian participants will transition to future experiments with the BELEN neutron detector at GSI/FAIR Darmstadt as part of the DESPEC collaboration.

¹³¹Technical Design Report ILIMA Heavy Ion Detector

¹³²A. Tarifeño et al., J. Instrum. 12, P04006 (2017)

¹³³A. Tolosa-Delgado et al., Nucl. instr. Meth. A925, 133 (2019)

¹³⁴V. Phong et al., Phys. Rev. C 100, 011302 (2019)

¹³⁵R. Yokoyama et al., Phys. Rev. C. 100, 031302(R) (2019)



Figure 3.27: (Part of the) BRIKEN group at RIKEN Nishina Center in Japan in 2017.

PREX and CREX: Measuring the neutron skin thickness (JLab) Manitoba; Croatia, Italy, Slovenia, Ukraine, USA

PREX, the Pb (lead) Radius EXperiment, uses the parity violating weak neutral interaction to probe the neutron distribution in ^{208}Pb , with the aim of measuring the root-mean-square neutron radius ($R_n(^{208}\text{Pb})$) to an accuracy of 1%. Data taking was completed in 2019, and the collaboration has presented preliminary unblinded results at the October 2020 APS DNP meeting.

CREX, the Calcium Radius Experiment, uses elastic scattering of polarized electrons from ^{48}Ca to measure $R_n(^{48}\text{Ca})$ to 0.9% precision. The collaboration started data taking in fall 2019 and is planning to resume in summer 2020 after a COVID19-related break. Data analysis should be completed by the end of 2022.

In combination, the results will challenge the assumptions of state-of-the-art nuclear structure models, with measurements for atomic mass number A in a regime where microscopic models can be applied to conditions in which the nucleon closely approximates infinite neutron-rich nuclear matter. By itself, the CREX result can help to illuminate specific details such as the role of three-neutron (3N) forces in microscopic calculations.

The Canadian collaborators at the University of Manitoba have made significant contributions to PREX-II and CREX in several crucial areas, for example as co-spokesperson for CREX (J. Mammei) and with simulation and design work. The group has also been responsible for the upgrade of the electron detector for the Hall A Compton polarimeter, and has provided the simulations of magnetic fields used to design the experiment and shielding of neutron backgrounds.

For more details, see Sec. 3.2.3.2.

Mass measurements with CPT (Argonne) Manitoba, McGill; USA

The Canadian Penning Trap (CPT) mass spectrometer was originally constructed for use at the AECL Chalk River Laboratories, and now has been operational at Argonne National Labora-

tory since 2001 (see Sec. 4.2.4.1). In combination with the CARIBU (Californium Rare Isotope Breeder Upgrade) fission fragment source it is ideally suited for high-precision measurements of very neutron-rich isotopes for r -process investigations .

Recent highlights include the measurement of neutron-rich nuclei in the so-called "Rare Earth Region" ($A=160-170$) which were compared with predictions from "reverse engineering" of the mass surface that best reproduces the solar abundances of the stable Rare Earth Peak nuclei (see e.g. Sec. 3.3.2.5). In this way a new semi-empirical mass surface can be extracted that sets constraints on yet unmeasured heavier isotopes. However, Canadian faculty involved in the CPT project has retired or is close to retirement.

Indirect neutron capture cross sections measurements with SuN (NSCL and Argonne) Guelph, TRIUMF; Norway, South Africa, USA

The new experimental program that has been started in collaboration with scientists at the NSCL in the USA and Norway aims at constraining neutron-capture cross sections of radioactive nuclei with various indirect methods. This is important for the reaction flow of the i and r process.

While the $^{142}\text{Cs}(d,p)^{143}\text{Cs}$ reaction will be studied at TRIUMF to infer the (n,γ) cross section indirectly, at Argonne National Laboratory a decay experiment will constrain the neutron capture into ^{143}Cs via the " β -Oslo method" using the SuN total absorption spectrometer. The combined data will offer the first direct comparison of reaction-based and β -decay techniques for constraining neutron capture rates experimentally.

In a follow-up step, one of the identified key reactions in the i process, the $^{135}\text{I}(n,\gamma)^{136}\text{I}$ reaction, will also be studied at Argonne National Laboratory.

Indirect reaction studies (MLL and TUNL) McMaster; Germany, USA

Studies exploring the sensitivity of nova nucleosynthesis to reaction rate uncertainties have found that the $^{38}\text{K}(p,\gamma)^{39}\text{Ca}$ reaction has a strong impact on the abundances of several elements near $A=40$ that are potentially observable in the nova ejecta, for example ^{38}Ar , ^{39}K and ^{40}Ca . This rate depends strongly on the resonance properties of low-lying ^{39}Ca excited states, above the proton threshold. Since the reaction rate depends exponentially on the energies of the resonances, these energies will comprise a significant uncertainty contribution to an experiment-based reaction rate. Additional experiments are therefore needed to reduce the uncertainty in the energies of known levels, and to search for new and important $^{38}\text{K} + p$ resonances.

The experiments at the (now closed) Maier-Leibnitz Laboratory (MLL) in Garching/ Germany and at TUNL/ USA aimed at a remeasurement of the $^{40}\text{Ca}(d,t)^{39}\text{Ca}$ and a new measurement of the $^{39}\text{K}(^3\text{He},t)^{39}\text{Ca}$ reaction in the energy range of interest. When combined with a high-resolution magnetic spectrograph, such as a Q3D spectrograph at the MLL or Split-pole spectrograph at TUNL, excitation energies have been determined with typical uncertainties of $\approx 2-4$ keV or smaller.

Pseudo-bar Neutron Array (Texas A&M) Saint Mary's; USA

A new type of neutron detector array, TexNEUT, has been developed in collaboration with Texas A&M which is planned to be brought to TRIUMF and coupled to the EMMA or IRIS facility for measurements (see Sec. 3.3.3.1)

The detector consists of a large-area, position-sensitive array of organic p-Terphenyl scintillator which has shown excellent n/γ pulse shape discrimination (PSD), fast timing, and high brightness. These properties make it an ideal fast neutron detector ¹³⁶. The project developed a new method of

¹³⁶A. Sardet et al., Nucl. Instrum and Meth. A 792, 74 (2015)

coupling discrete p-Terphenyl cubes (see Fig. 3.28) into a pseudo-bar geometry, with sensitivity to the cube of interaction. This enables the construction of large-area arrays with centimeter position sensitivity and PSD thresholds in the order of 100 keVee. A 128-bar array is presently under construction and will be used for indirect (d, n) and neutron-decay experiments at the Cyclotron Institute at Texas A&M and at TRIUMF. Initial work will center around an envisioned proof-of-principle experiment measuring the $^{26}\text{Al}(d, n)^{27}\text{Si}$ reaction by coupling TexNEUT to either EMMA or IRIS.

The medium-term plans are to develop a new, dedicated detector for neutron spectroscopy at TRIUMF. The envisioned detector will be constructed of p-Terphenyl using a similar pseudo-bar concept to TexNEUT. The applications of the array will be complimentary to existing neutron detectors at TRIUMF such as DESCANT. It will be targeted towards time-of-flight neutron spectroscopy with high resolution, high granularity, and n/γ PSD. The array is expected to be sensitive to neutrons with energies of a few 100 keV up to 10 MeV. In addition to transfer reactions, the array will also be suitable for in-flight neutron decay spectroscopy, β -delayed neutron spectroscopy, and direct measurements of astrophysical (α, n) or (p, n) reactions.

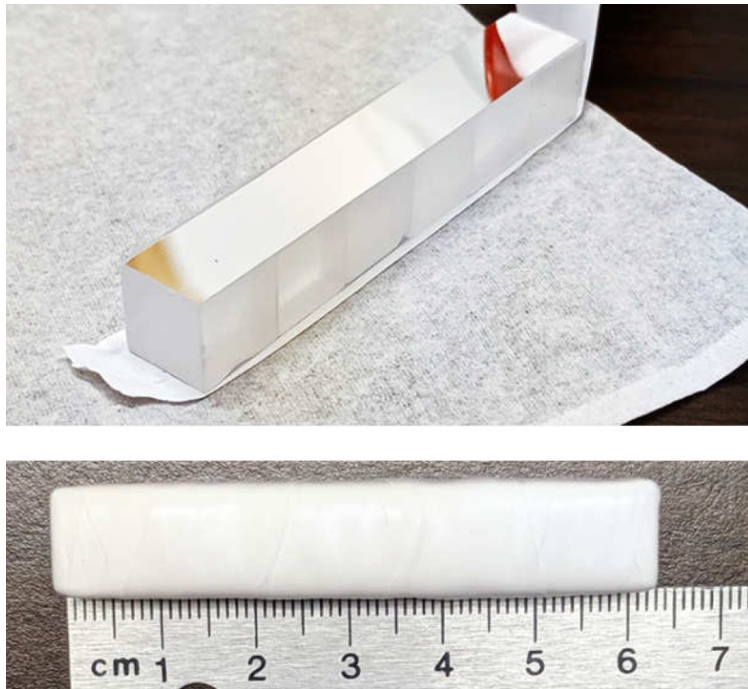

Figure 3.28: Photograph of an un-wrapped (top) and wrapped (bottom) pseudo-bar consisting of six $1\text{ cm} \times 1\text{ cm} \times 1\text{ cm}$ cubes of the neutron scintillator p-Terphenyl. Light from either end of the bar is read out with photomultiplier tubes or silicon photomultipliers. A similar design is envisioned for the detector planned for TRIUMF.

3.3.4 Beyond the next five years

The main focus of the Canadian community for the time beyond 2027 will be without doubt the full exploitation of the new opportunities that the ARIEL project will bring. At the same time, FRIB in the USA will also be in full swing, and in Germany the first beams from the new FAIR facility

will become available. Canadian nuclear astrophysicists will be involved in research programs at all of these new RIB facilities.

3.3.4.1 New setups at the ISAC facility

One of the main goals for the existing ISAC facility will be to complement its already diverse selection of experimental setups with new detectors that complement the ongoing physics program and will make full use of the upcoming photofission beams from ARIEL.

New detectors The pseudo-bar neutron array (see Sec. 3.3.3.2) will allow a versatile program, e.g. making use of the intense re-accelerated beams of heavy nuclei provided by CANREB with dedicated (d, n) experiments on rp-process nuclei. Coupling of the neutron detector to the new EXACT-TPC for nuclear structure would allow measurements on proton-dripline nuclei as well as three-body decays of neutron-unbound states with beam intensities that can be as low as a few hundred particles per second. Other experiments, like direct (p, n) and (α, n) reactions important for core-collapse supernovae are envisioned by coupling the detector to EMMA.

TRIUMF Storage Ring (TRISR) The by far largest future project in the nuclear astrophysics community will be the planned installation of a low-energy storage ring with a neutron generator target at the ISAC facility. Heavy ion storage rings connected to an ISOL facility provide a unique environment to carry out nuclear physics experiments with stored radioactive beams due to the up to six orders of magnitude increased luminosity compared to "one-time-pass" experiments. The installation of a low-energy storage ring at ISAC-I would create a worldwide unique facility and provide a valuable extension of TRIUMF's physics program by attracting new users.

About ten years ago, the CERN/ISOLDE facility had plans to re-use the [Test Storage Ring \(TSR\)](#) which was formerly installed at the Max-Planck Institute for Nuclear Physics in Heidelberg/Germany ¹³⁷. This project was deferred until after 2025. In the meantime a new design of a storage ring at ISOLDE, the ISR, has been brought up within the possible upgrades outlined in the EPIC project (Exploiting the Potential of ISOLDE at CERN) that was submitted to the European Strategy for Particle Physics update in December 2019. However, this new project is still missing approval from CERN and funding.

The TRISR at ISAC is building on these initial ideas but has many advantages. The storage ring will be designed in such a way that it will fit into the existing ISAC-I facility, without the need of a facility upgrade or an annex building (see Sec. 4.1.1.5 and Fig. 4.2). It will be a low-energy storage ring ($E \approx 0.1\text{--}10$ MeV/u) and the envisioned nuclear (astro)physics program will complement the existing program at ISAC. The TRISR will have an electron cooler (for decreasing the emittance of the beam) and potentially an internal gas (jet/droplet) target.

It is planned to couple a D-D neutron generator (e.g. the [Thunderbird compact generator from PHOENIX LLC](#) in Madison, WI/ USA) with the storage ring to allow –for the first time ever– to measure direct neutron capture cross sections of short-lived radionuclides. The D+D fusion produces neutrons with an average energy of 2.45 MeV which would be moderated down to lower (astrophysically relevant) energies for capture reactions with the radioisotope beam circulating in the storage ring.

Neutron capture cross sections on radioactive nuclei are an important input parameter for all three heavy-element neutron capture processes (s , r , and i process). Direct measurements were

¹³⁷M. Grieser et al., [Eur. Phys. J. Spec. Topics](#) 207, 1 (2012)

so far hampered by unavailability of proper macroscopic targets of both, the respective short-lived nuclei and neutrons. Neutron capture cross sections have been measured on longer-lived radioactive targets that could be produced in amounts in the order of a few μg (corresponding to $\approx 10^{16}$ atoms). For shorter-lived nuclei, indirect (surrogate) methods with e.g. (d, p) reactions have to be used instead (see the ongoing research program at EMMA, Sec. 3.3.3.1).

The plan is to submit an NSERC Project Grant in 2022 to initiate the machine study, define the physics program and the international collaboration, and prepare a Technical Design Report by 2024/25. This project with a cost of $\approx \text{C}\$30\text{--}40$ million would then be submitted as CFI proposal in 2025. If funding is successful, construction could start by 2026 and first physics experiments could be carried out by 2030/31.

Such a facility would be world-wide unique and open up a completely new research stream at ISAC. In addition, the facility is greatly benefiting from the higher intensities and cleaner neutron-rich beams in the ARIEL project.

3.3.4.2 Theoretical Developments

Astrophysical Signatures aim to incorporate the effects found on neutrino oscillations and nucleon interactions directly into simulations of compact objects' evolution. The aim is also to develop Molecular Dynamic simulations of the accreting neutron star crust that allow a consistent study of neutron super fluidity and exotic nuclear structure, e.g nuclear pasta, in abundance evolution of rp-process ashes. Furthermore, temperature effects on neutron captures will be studied, and α decay relevant for the rp- and r-processes. Those studies will provide a narrow set of reactions key in the synthesis of heavy elements that will guide experimental searches.

Ab-initio theories A future challenge for the *ab-initio* theory is to address nuclear deformation. If successful, a comprehensive *ab-initio* description of the atomic nucleus applicable to light and medium mass nuclei will be achieved, with an increasing mass reach as the computing power increases to exascale and beyond. Further developments will allow to calculate processes with three charged particles in the final states, such as $^{11}\text{B}(p, \alpha\alpha)^4\text{He}$ considered for aneutronic fusion energy generation. Nuclear quantum many-body problem will greatly benefit from the development of quantum computing capabilities. The implementation and development of quantum algorithms for *ab-initio* nuclear theories is also planned.

For the VS-IMSRG model the plan in the next decade and beyond is to extend the predictions to the driplines. A possibility is also the exploration of superheavy elements and the search for a potential island of stability around $A \approx 300$.

3.3.5 Summary

The Canadian nuclear astrophysics community has evolved enormously over the past decade and has taken a leading role in the worldwide research program. The extent of this chapter and the diversity of the experiments described here displays the popularity of this interdisciplinary field. The big question for the next decade and beyond is “*What is the role of radioactive nuclei in shaping the visible matter in the universe?*”, and it will be driven by the new research possibilities enabled by the new generation of radioactive beam facilities. The main experimental setups are already installed and running, ready to take beam and to push the limits of nuclear astrophysical knowledge further out.

The domestic nuclear astrophysics program at TRIUMF-ISAC will benefit twofold from the upcoming ARIEL era: on one hand due to cleaner radioactive, neutron-rich beams for studies related to the rapid and intermediate neutron capture process; on the other hand due to the increase in available beamtime that will allow longer experiments to investigate astrophysical reaction rates with smaller cross sections or lower intensities.

The next 5 years will see a multitude of additional (auxiliary) detectors being built to complement the already ongoing physics program. The next "large" multi-million (Canadian) Dollar facility in this decade that is being discussed by the community might be the TRIUMF Storage Ring with a neutron generator target (see Sec. 4.1.1.5). With the proper investment in additional HQP and faculty positions these efforts will lead to a further growth and strengthen the Canadian leadership in this field.

3.4 Fundamental Symmetries

3.4.1 Overview

Low energy tests of fundamental symmetries in nuclei and atoms have traditionally played an important role in the search for ‘new’ physics beyond the Standard Model (SM). The field is more active than ever, particularly in Canada, where it is represented by the working group “Fundamental Symmetries” within the Canadian Institute of Nuclear Physics (CINP). The study of symmetries in subatomic physics is of key importance for two reasons. On one hand, the fundamental forces and conservation laws of nature are intimately linked to corresponding symmetries; the investigation of those symmetries and their violations give unique insights. In addition, from a practical point of view, symmetries can be exploited to single out vanishingly small signatures of new physics in the presence of much larger ‘conventional’ interactions, giving low-energy experiments a physics reach to energy scales orders of magnitude higher, and keeping them competitive with direct searches conducted at colliders. As an example, at the Z -resonance, the neutral current weak interaction dominates over electromagnetism as real Z bosons are readily observed in $e^+ - e^-$ collisions; in an ordinary atom with binding energies on the order of electron volts, the Z -boson exchange amplitude between electrons and quarks is 12 or more orders of magnitude suppressed relative to the prevalent electromagnetic photon exchange, yet with help of the violation of the parity symmetry in the Z -exchange, this amplitude has been measured to 0.3%, providing an important test of electroweak physics.

Our current understanding of the fundamental interactions and symmetries is reflected in the Standard Model; constructed half a century ago, it is still in agreement with experimental findings. It is a quantum field theory founded on the assumptions Lorentz symmetry and invariance under the combined transformation of charge (C), parity (P), and time reversal (T), or CPT. Since the 1950’s and 60’s we know that C, P, CP, and T are violated separately. However, the Standard Model contains an uncomfortably large number of free parameters, and while the P and CP symmetry violations have been successfully incorporated, the Standard Model cannot explain their origin. In addition, no link exists between the Standard Model and gravity.

Theories such as quantum gravity and string theory are pursued intensely as a unifying approach valid up to the Planck scale. While they yield the Standard Model and General Relativity in the low-energy regime, they frequently assume Lorentz and CPT violation. High precision, low-energy fundamental symmetry-type experiments in nuclei and atoms can probe for very faint remnants of these symmetry violations occurring at energies far beyond the current frontier of direct searches.

In Canada, there is currently a strong community of researchers working on fundamental symmetry tests. The work covers many of the hot topics and also has a remarkable breadth in the experimental approaches, from electron scattering experiments at the 10 GeV level to beta decay in laser traps using atoms at neV temperatures, a span of 19 orders of magnitude in energy!

3.4.2 The Canadian program

3.4.2.1 Time reversal and CP violation: Permanent electric dipole moments and related searches

The CP violation in the Standard Model is 10 orders of magnitude smaller than needed to generate the observed baryon asymmetry of the universe in the method outlined by Sakharov. The observation of a non-vanishing permanent electric dipole moment (EDM) in an atom, nucleus, or

the neutron would directly violate time reversal symmetry (and also CP, assuming CPT symmetry holds), independent of any need for radiative corrections or theoretical interpretation. EDM searches are among the hottest topics for physics beyond the Standard Model worldwide and have made great progress over the years in ruling out theories beyond the SM, as illustrated in Figure 3.29.

Several Canadian groups are active in this field at the confluence of atomic, nuclear, and particle physics. Experiments are under development or in the planning stage at TRIUMF, exploiting a unique mix of capabilities: The cyclotron is the backbone of the high-density, ultra-cold neutron facility, enabling a competitive neutron EDM search. It is the driver for the actinium targets at ISAC, which produce record quantities of radioactive, heavy elements such as Rn, Fr, and Ra which are of particular interest for fundamental symmetries studies due to the large enhancement of T/CP (and also P) violating interactions. A possible search for an electron EDM in Fr and T-violating triple-correlation measurements in ^{45}K (discussed in 3.4.2.5) and in radiative β decay harness the world-leading radioactive neutral atom trap infrastructure at ISAC. ARIEL rounds out the synergies by enabling long, dedicated campaigns with actinide target beams.

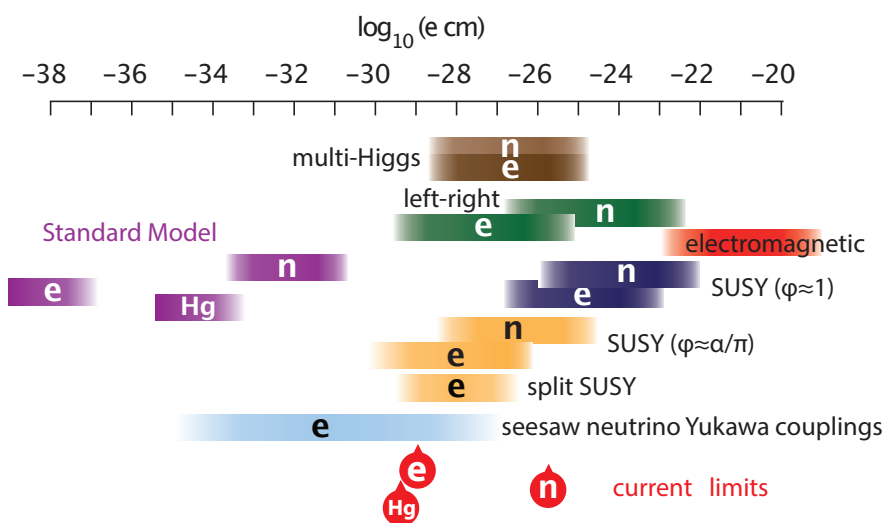

Figure 3.29: Experimental limits on permanent electric dipole moments and a rather incomplete and imprecise selection of predicted ranges for various theories. Initial version inspired by [J.M Pendlebury and E.A. Hinds, Nucl. Meth. Instr. A 440, 471 \(2000\)](#). For up-to-date, detailed information, see the review by [T.E. Chupp *et al.* Rev. Mod. Phys. 91, 015001 \(2019\)](#).

TUCAN: towards an improved measurement of the neutron’s permanent electric dipole moment (TRIUMF) TRIUMF, Winnipeg, Manitoba, SFU, UNBC; Japan, USA

The TUCAN (TRIUMF Ultra-Cold Advanced Neutron) collaboration is currently building an advanced, spallation-driven superfluid helium (He-II) source of ultra-cold neutrons at TRIUMF. The first physics goal is to carry out a measurement of the neutron electric dipole moment, with an envisioned improvement of about an order of magnitude ($\delta d_n \approx 1 \times 10^{-27}$ e-cm), placing tighter constraints on CP violation in the hadronic sector. At this level, numerous theories beyond the Standard Model can be critically tested. Measurements of the neutron EDM are complementary in their sensitivity to new physics, compared to measurements of EDMs in other systems such as

atoms and molecules ¹³⁸, and have strong impact on the SUSY CP problem, baryogenesis scenarios, and CP violation in the strong sector.

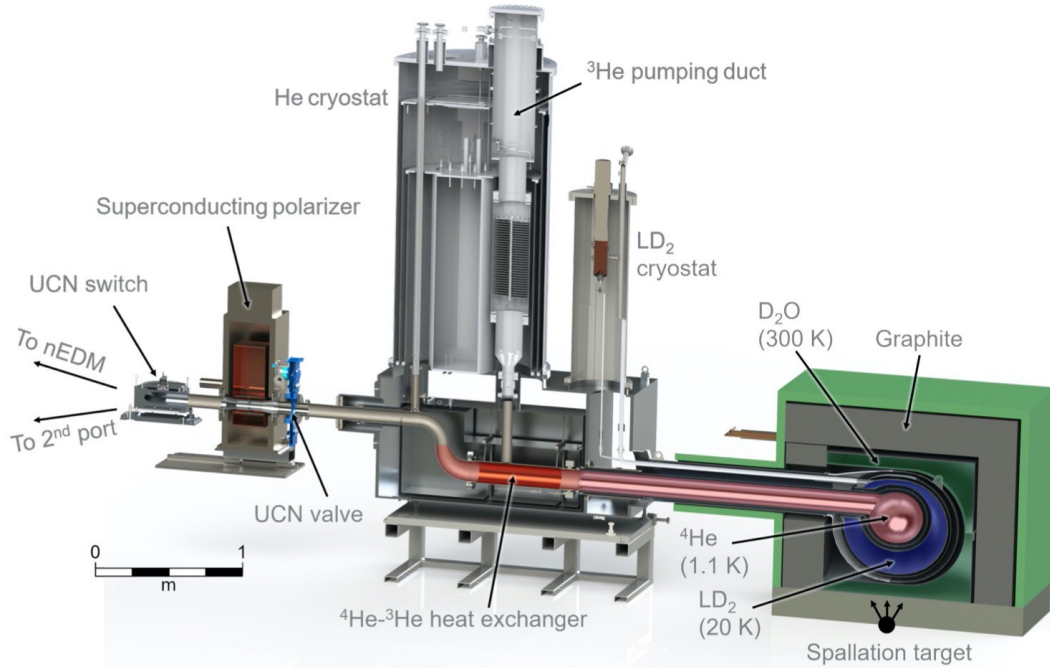

Figure 3.30: TUCAN: Cross section of the future UCN source scheduled to be installed in 2021-22.

Over the past years, a beamline and a UCN source were successfully established and tested ¹³⁹. A few of the research highlights are the first UCN production at TRIUMF, and the characterization of UCN production and UCN interactions with superfluid helium ¹⁴⁰. A new fast kicker magnet was designed, built, and commissioned ¹⁴¹ which feeds a new proton beamline and spallation target ¹⁴². The facility was operated routinely from 2017-2019 and used for R&D related to the UCN source upgrade and EDM experiment. A CFI-funded source upgrade is now under way, with a new He-II cryostat provided by the collaborators from Japan, currently being tested at KEK. Co-magnetometry, magnetic shielding and detectors are also being developed.

In 2020-21, the new horizontal He-II cryostat will be shipped from Japan and installed and tested at TRIUMF (see Figure 3.30). In 2022, first operation for UCN production will be conducted. The magnetically shielded room which will house the EDM experiment will be installed and characterized with precision magnetometers. In 2023, the EDM experiment will be assembled and commissioned, with running occurring for the next two to three years thereafter.

The EDM experiment will run into the 2027–36 period, and data analysis will be ongoing throughout this period. The data will be blinded and analyzed by multiple groups. Upgrades to the EDM experiment could be considered in this period, and will depend on what is learned during the years of operation prior to this point. The UCN source is designed to be a two-user facility, and

¹³⁸T.E. Chupp *et al.* *Rev. Mod. Phys.* 91, 015001 (2019).

¹³⁹S. Ahmed *et al.*, *Phys. Rev. C* 99, 025503 (2019).

¹⁴⁰Ibid.

¹⁴¹S. Ahmed *et al.*, *Phys. Rev. Accel. Beams* 22, 102401 (2019).

¹⁴²S Ahmed *et al.*, *Nucl. Instrum. Meth. A* 927, 108 (2019).

other experiments are considered that may use the second experimental port, such as a neutron lifetime experiment (V_{ud} , neutron lifetime puzzle), and a neutron gravitational levels experiment (extra dimensions, chameleon fields, short-distance modifications to gravity). It is anticipated to develop TUCAN into a user facility where outside groups would submit experimental proposals.

Radioactive molecules as a sensitive probe for permanent electric dipole moments (TRIUMF) TRIUMF, Toronto, UBC; USA, Belgium, Germany, Netherlands, UK

In certain molecules, parity and time-reversal violation effects can be greatly enhanced compared to atomic systems ¹⁴³. As these symmetry-violating effects scale with the atomic number, nuclear spin and nuclear deformation, measurements of molecular isotopologues containing heavy radioactive nuclei are predicted to provide unique and highly sensitive laboratories in these studies. However, experimental measurements of such radioactive molecules are scarce, and their study requires overcoming major experimental challenges. This research program at TRIUMF focuses on precision studies of radioactive molecules, which will offer new opportunities for the study of the nuclear electroweak structure and the violation of fundamental symmetries. The proximity of molecular states of different parity can enhance P and T violating sensitivity by orders of magnitude when compared to atomic systems. Moreover, certain radioactive molecules can contain heavy nuclei with octupole deformation, providing further sensitivity enhancements to explore P and T violation ¹⁴⁴. The proposed program at ISAC/TRIUMF targets permanent electric dipole moments in systems with sensitivity to the electron's EDM and P,T -violating nuclear Schiff moments, as well as parity violation.

Radioactive ions will be produced at ISAC/ARIEL and sent into a cryogenic buffer gas cell where molecules can be formed by interactions with the gas (see Fig. 3.31). The molecules will be extracted, selected and transferred to a cryogenic radiofrequency quadrupole trap, where the internal and translational temperature of the molecular ions will be reduced. Ions will be released with a kinetic energy of a few eV, neutralized, and decelerated down to sub-eV. Cold and slow molecular beams will be transported through a optical pumping region, where they can be transferred to a preferred molecular state. Subsequently, the molecular beam will interact with electric and magnetic fields. Finally, the population of a particular molecular state can be studied for different configurations of the external fields, providing information on a specific symmetry-violating effect.

In a first stage, the formation and properties of RaF will be studied ¹⁴⁵, followed by precision spectroscopy (at the MHz level) of the hyperfine structure. Next would be optical pumping and radiofrequency spectroscopy with kHz resolution, and the production of slow, cold RaF beams. Finally, spectroscopy at the Hz level, in the presence of electric and magnetic fields, has to be demonstrated, to measure parity violating effects in a molecular beam. Subsequently, a magneto-optical trap for RaF would be attempted. Post 2025, such a setup could be used to carry about competitive EDM searches, with increasing precision over 3 to 5 years. Collaborators at MIT, Caltech, Edinburgh, and TRIUMF have started on developing the required tools and techniques.

Similarly, the broader AMO community has established techniques to construct trapped cold diatomic molecules from separate laser-cooled atoms, possibly providing very long coherence times for EDM experiments. There is ongoing consideration in the community to form diatomic molecules with octupole-deformed laser-cooled ^{223,225}Ra and ²²³Fr as the heavy atom. Since low- Z alkali atom

¹⁴³M. Safronova *et al.*, *Rev. Mod. Phys.* 90, 025008 (2018).

¹⁴⁴V.V. Flambaum *et al.*, *Phys. Rev. C* 99 035501 (2019).

¹⁴⁵R.F. Garcia Ruiz *et al.*, *Nature* 581, 396 (2020).

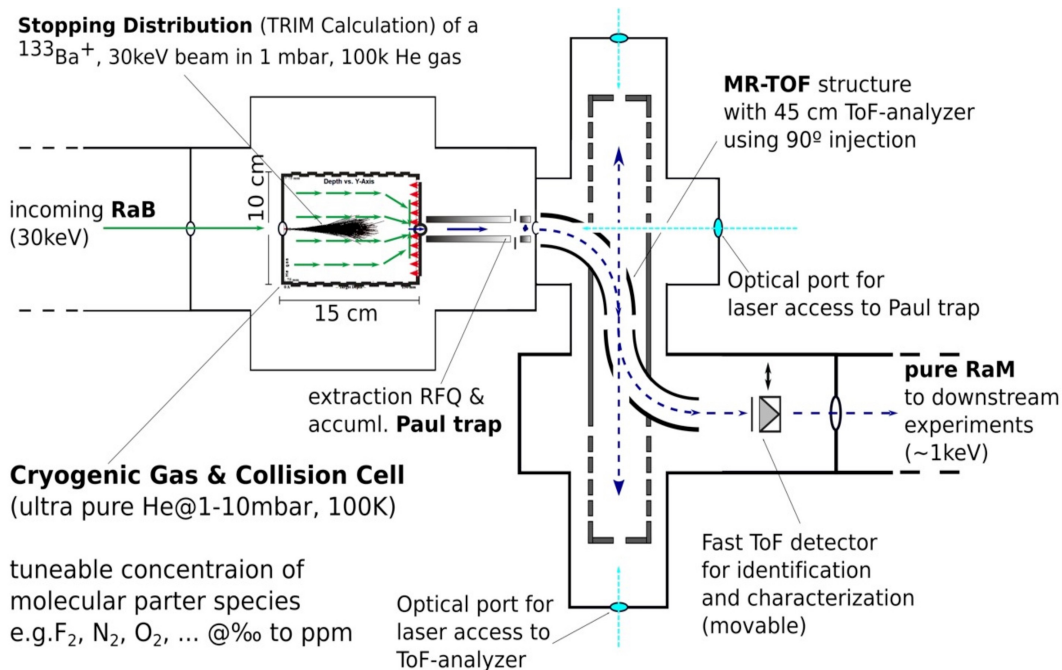

Figure 3.31: Schematic of a setup for precision spectroscopy with cold radioactive molecules (note that *RaB* stands for *radioactive barium* and *RaM* for *radioactive molecule*, e.g. RaF or RaO).

partners do not produce dimers with useful sensitivity to EDM effects, the challenge is to develop useful atomic partners which are inherently more difficult to laser cool.

Searching for a permanent electric dipole moment of the electron with an atomic fountain: FrEDM (TRIUMF) TRIUMF, Manitoba; USA

The goal of the FrEDM effort is to competitively constrain a permanent electric dipole moment (EDM) of the electron, using a laser-cooled francium atom fountain supplied by an intense beam of ^{211}Fr from TRIUMF. Such EDM's break time-reversal symmetry, a key component of models to explain the excess of matter over antimatter. This experiment would be complementary to a variety of EDM experiments in the neutron and in atoms with or without spin, along with a number of particle physics experiments. High- Z francium atoms feature a high sensitivity to an EDM, low sensitivity to EDM mimicking systematic effects, and extraction of the subatomic time-reversal violating (TRV) physics to high accuracy. The experiment will be developed at LBL using stable Cs as a lower-EDM sensitivity and higher-systematic sensitivity surrogate. Following the Cs prototype, a fully developed Fr experiment can make efficient use of TRIUMF time, space and resources. The aim is a sensitivity to an electron EDM at $\approx 1 \times 10^{-29}$ e-cm, similar to the sensitivity published by ACME's ThO measurement, which appears attainable ¹⁴⁶. Complementarity with particle physics results make the case for improvements particularly compelling. Among experiments that search for an electron EDM, experiments using alkali atoms and thallium are the gold standard, because their sensitivity to the electron EDM has been calculated using field theory (as has the sensitivity of the neutron to quark EDMs). That puts these quantities on the same theoretical footing as the

¹⁴⁶N. Hutzler *et al.*, Nature 562, 359 (2018).

calculations that underlie the Standard Model.

A francium version of the experiment could run and achieve design sensitivity by 2026. On the 2027-2036 horizon, with motivation depending on other advancements in the field, considerable effort would be needed to improve certain limiting systematics (e.g. Johnson noise in the mu-metal shield) for the francium atom EDM. Furthermore, this effort could lead over into one using laser-cooled molecules, as briefly discussed in the previous section.

3.4.2.2 Neutral current weak interactions

The violation of parity symmetry provides for an extremely sensitive means to study the neutral current weak interaction, which is generally masked by the dominating electromagnetic processes. P-violating physics beyond the Standard Model at the TeV scale can be observed in low-energy experiments, keeping this field competitive in the LHC era (see Figure 3.32). For example, when new states are discovered at the LHC, it will be important to know their couplings to the first generation of particles. Electrons and muons can be distinguished in the LHC detectors, but up/down quark jets cannot be separated from jets of other generations. Low-energy experiments are in a unique position to assist with this question. There are three types of such “low-energy” weak neutral current measurements with complementary sensitivity.

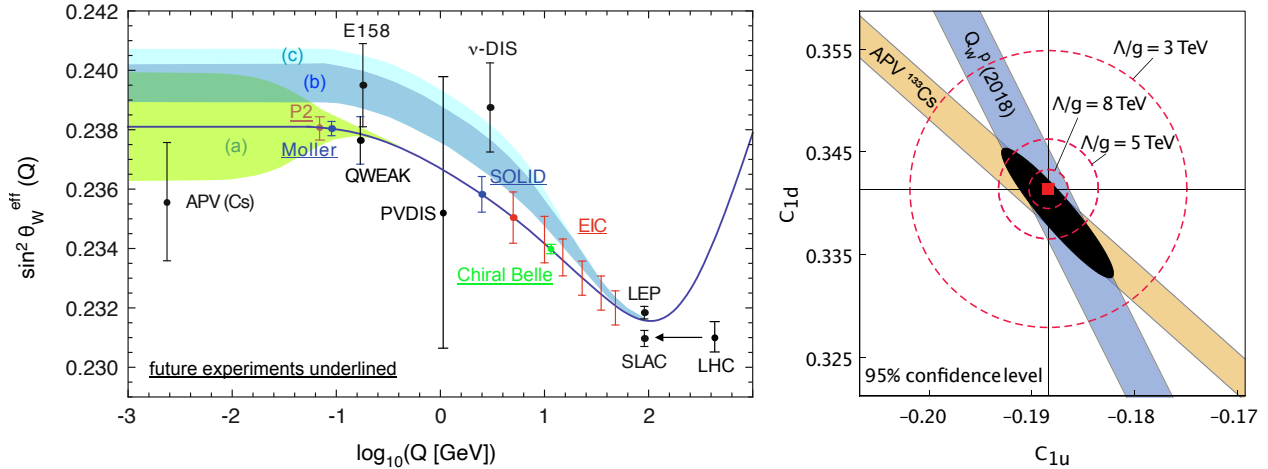

Figure 3.32: Left: Past and future measurements of the Weinberg angle. Data points for future experiments are arbitrarily centered on the Standard Model prediction (solid black line). Figure adapted from A. Accardi *et al.*, *Eur. Phys. J. A* 52, 268 (2016), Chiral Belle from J.M. Roney, *PoS LeptonPhoton2019*, 109 (2019). Scenarios with dark Z bosons for m_{Z_d} of (a) 50 MeV, (b,c) 15 GeV (where area (c) is in tension with existing constraints) from H. Davoudiasl *et al.*, *Phys. Rev. D* 89, 095006 (2014) and H. Davoudiasl *et al.*, *Phys. Rev. D* 92, 055005 (2015). Right: Constraints of parity-violating electron-quark couplings provided by Qweak and atomic parity violation in cesium. The red square denotes the SM prediction. This plot by D. Androic *et al.*, *Nature* 557, 207 (2018) highlights the complementarity of these measurements.

Electron-electron scattering (MOLLER) is measuring the electron’s weak charge, electron-proton scattering (Qweak) determines the proton’s weak charge and atomic parity violation (FrPNC) is predominantly sensitive to the neutron’s weak charge. Different types of new physics contribute differently to each of them. For example, the atomic weak charge is relatively insensitive to one-

loop order corrections from all SUSY particles; Moeller scattering is purely leptonic and has no sensitivity to leptoquarks. The Canadian community has had a long, prominent involvement in parity-violating scattering experiments and is playing a major role in the Qweak and MOLLER collaborations at Jefferson Lab. In addition, the FrPNC collaboration aims to measure atomic parity violation in laser-trapped francium at TRIUMF, ultimately hoping to improve on the Cs result. The Canadian involvement in the PREX/CREX experiments (discussed in the astrophysics section) nicely ties into this work by providing critical input to the francium experiment via the determination of nuclear neutron radii. As shown in Fig. 3.32, the upcoming electron-ion collider EIC (discussed in the section on hadronic physics) will provide important data in the region between low-energy experiments and the Z -pole.

Theoretical work on one-loop and two-loop electroweak radiative corrections of critical importance to the parity experiments is carried out by groups at Memorial and Manitoba, presented in detail in Sections 3.5.2.4 and 3.5.2.7.

Parity violating electron scattering: MOLLER (JLab); Manitoba, Memorial, TRIUMF, UNBC, Winnipeg; France, Germany, Italy, Mexico, USA.

Within the Standard Model, the combined electro-weak interaction strength of electrons is parameterized by the so-called electron weak charge, which is itself related to the weak mixing angle, a fundamental parameter of the Standard Model that sets the degree of mixing between the electromagnetic and weak interactions.

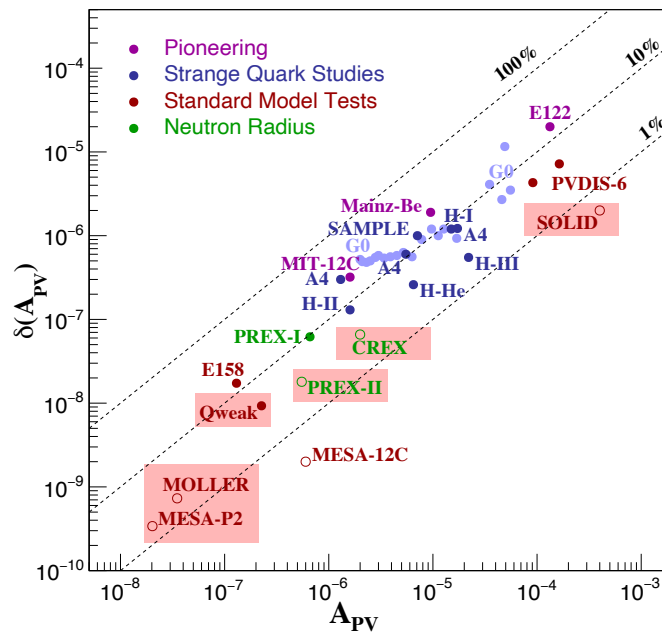

Figure 3.33: Parity violating electron scattering, experimental precision $\delta(A_{PV})$ shown versus the parity violating asymmetry A_{PV} (P. Souder and K.D. Paschke, *Frontiers of Physics* (Beijing) 11 no.1, 111301 (2016)). Open circles are either not yet published or future experiments. Efforts discussed in this report are shaded red.

While design efforts for MOLLER have been ramping up over the past years, the predecessor

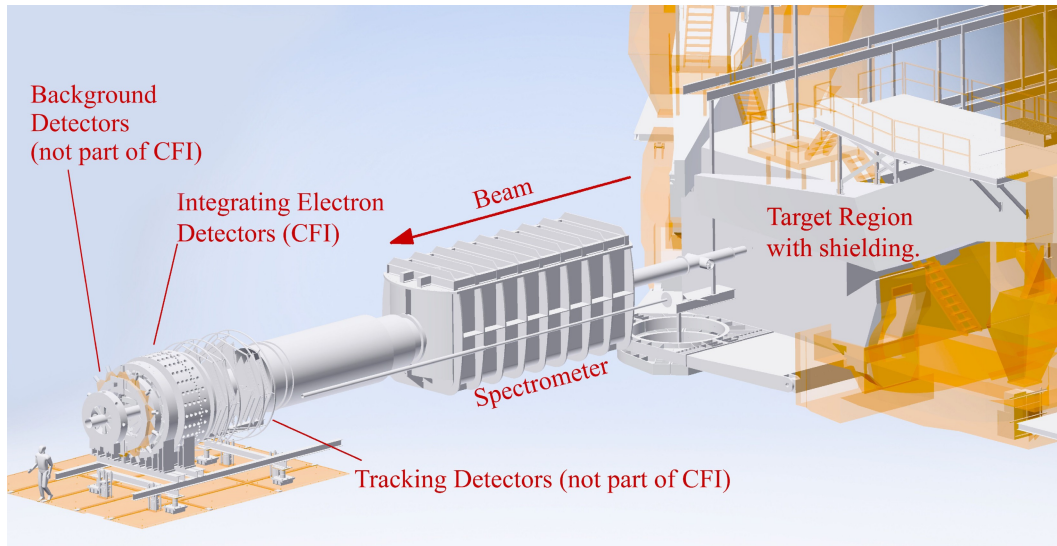

Figure 3.34: Layout of the MOLLER experiment in Hall A at Jefferson Lab: The beam enters from the right, traveling toward the left. The primary Canadian contribution are the CFI proposed main integrating detectors, shown on the left end.

Q_{weak} , measuring the weak charge of the proton, saw data analysis finalized and the publication of the results ¹⁴⁷. The weak charge of the proton was determined as 0.0719 ± 0.0045 , derived from the parity-violating asymmetry in the scattering of polarized electrons on protons, measured at the 9 ppb level (see Fig. 1.3). The result is in excellent agreement with the SM prediction, and sets multi-TeV-scale constraints on any semi-leptonic parity-violating physics not described within the SM.

The MOLLER experiment aims to make the world’s most precise off-resonance measurement of the weak mixing angle, using polarized electron-electron scattering at Jefferson Laboratory to observe the parity violating asymmetry at the percent level (see Figure 3.33). The experiment will test the interaction of electrons with respect to a number of new physics models and will search for electron substructure at the 10^{-21} meter scale. The electron-electron interaction is the cleanest process that exists among fundamental particles, uncontaminated by nuclear interactions and is experimentally extremely well controlled, and therefore a prime candidate to search for new physics. MOLLER is an international effort, presently involving more than 120 collaborators from the USA and Canada (the lead countries), as well as Germany, Italy, France, and Mexico. The current Canadian group includes about 20 people, which makes it the second strongest contiguous group in the project, behind Jefferson Lab. MOLLER employs elastic scattering using the 11 GeV electron beam at Jefferson Lab, and it requires a large, highly efficient, and precise array of electron detectors. The Standard Model prediction for parity violating asymmetry A_{PV} , for the proposed experimental design, is $\approx 33 \times 10^{-9}$ and the 2.4 % relative error goal corresponds to an overall precision of 0.7 ppb on the asymmetry measurement, which in turn corresponds to a ≈ 0.1 % determination of the weak mixing angle.

The Canadian team is leading the design of the magnetic spectrometer and the integrating detectors plus associated electronics (shown in Figure 3.34), and further established leadership

¹⁴⁷D. Androić *et al.*, *Nature* 557, 207 (2018).

roles in simulation and analysis software. Design completion and prototype testing will finalize in 2021, and construction is scheduled to begin in 2022, with commissioning around 2025. MOLLER will take data until 2030 with a few years of data analysis to follow.

The group is also involved in the P2 experiment at the MESA facility in Mainz, Germany. The synergies with MOLLER in terms of detector electronics are substantial, and the timeline is expected to be comparable to MOLLER.

Atomic parity violation in laser-trapped francium at TRIUMF (TRIUMF) Manitoba, TRIUMF; Mexcio, USA

In atoms, extremely weak electric dipole transitions between states of the same parity are induced by the parity-violating exchange of Z-bosons between the electrons and the quarks in the nucleus, an effect known as atomic parity violation (APV). Measuring this amplitude, one can study neutral-current weak interactions with atomic physics methods and search for ‘new’ physics such as extra gauge bosons and leptoquarks. APV is strongly enhanced in heavy atoms (18 times larger in Fr compared to Cs), but is presently only sufficiently calculable in alkalis. While this makes Fr an obvious choice, its lack of a stable isotope requires work at a radioactive beam facility such as ISAC. There, the FrPNC collaboration has established a laser trap facility that can capture $\approx 10^6$ atoms of a single Fr isotope in a volume of $\approx 1 \text{ mm}^3$ at μK temperatures, an ideal environment for precision laser spectroscopy towards APV measurements.

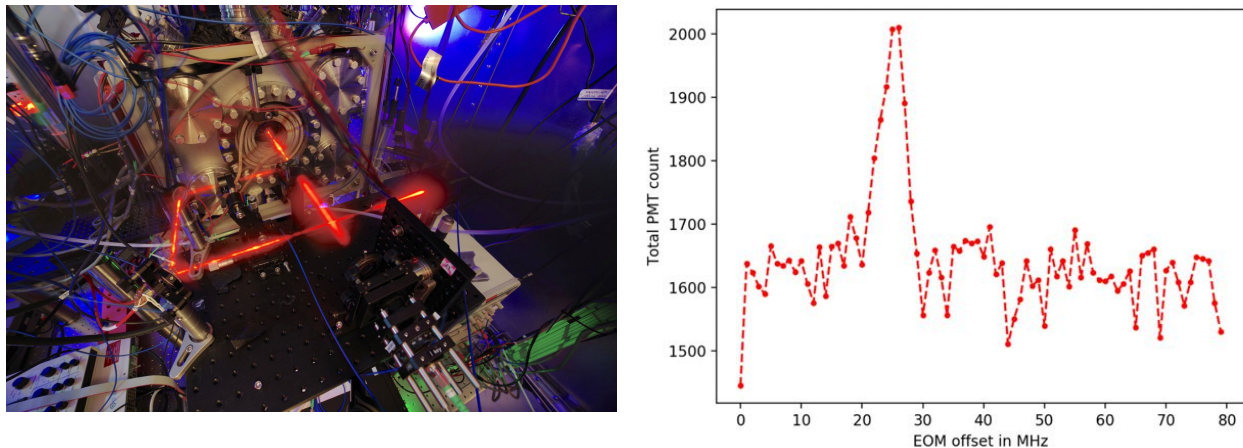

Figure 3.35: Left: Online francium atom trap for spectroscopy of highly forbidden, Stark-induced transitions. Right: Observation of $7s - 8s$ vector (β) Stark-induced transition.

Following initial commissioning work ¹⁴⁸, focus has shifted on the observation of the highly forbidden $7s - 8s$ transition ¹⁴⁹, and recently observed as a Stark-induced single photon transition with oscillator strength of $\approx 10^{-10}$ (see Figure 3.35). In the coming years, a program of spectroscopy of increasingly faint transition amplitudes will be carried out, in particular characterization of the relativistically induced M1, with the ultimate goal of observing the interference between the parity violating amplitude with the much larger, Stark-induced E1. By mid-decade, when ISAC/ARIEL

¹⁴⁸J. Zhang *et al.*, Phys. Rev. Lett. 115, 042501 (2015).

¹⁴⁹M. Kalita *et al.*, Phys. Rev. A 97, 042507 (2018).

will provide up to 3 beams simultaneously, statistics runs could take place for a competitive APV measurement. On the longer horizon, 2027-36, the Fr laser trap facility could merge into efforts with ultra-cold molecules, photo-associated from laser-cooled atoms, to which Fr would contribute its high sensitivity to new physics, wide range of isotopes, including deformed ones, and structural simplicity (see outlook at end of this section).

Fundamental symmetries at the EIC (Brookhaven) Manitoba, Regina; USA and others

In addition to the hadronic physics program, the EIC presents opportunities in the area of fundamental symmetries and neutral current weak interactions. To maintain the flow of the description of the EIC program, the parity violation and lepton flavor violation program and their discovery potential are described in 3.1.3.

3.4.2.3 CPT, Lorentz and weak equivalence principle violation

CPT invariance and Lorentz symmetry are at the very foundation of our current description of nature, as quantum field theories are firmly based upon these principles. However, in string theory and also in quantum gravity, which unifies the standard model of particle physics with general relativity in a ‘theory of everything’, CPT and Lorentz violation are frequently assumed. Furthermore, the weak equivalence principle — a fundamental assumption in Einstein’s general relativity — may be violated at a minute level in a fundamental theory. As low-energy experiments are, relatively speaking, not that much further away from the Planck scale as are colliders, the former play a very significant role in this field, driven by the extreme precision that can be reached mostly with laser and microwave-based measurement techniques. Canada is strongly involved in the high-profile endeavor of anti-hydrogen trapping and antimatter spectroscopy, and it provides the largest contingent by country in the ALPHA collaboration working at CERN.

ALPHA: Testing fundamental symmetries via antihydrogen-hydrogen comparison — (CERN); Calgary, SFU, TRIUMF, UBC, York; Brazil, Denmark, Israel, Sweden, UK, USA, Switzerland

The ultimate goal of antihydrogen studies is to test fundamental symmetries between matter and antimatter with the highest possible precision. Precision tests of CPT and the Weak Equivalence Principle (WEP) will confront the foundations of modern physics – quantum field theory and general relativity. The ALPHA experiment located at CERN has played the leading role in this endeavour over the past 15 years. The current configuration of the apparatus is shown in Fig. 3.36. ALPHA is now firmly into the precision measurement stage using the ALPHA-II atom trap (left part of Fig. 3.36), and over the past five years has delivered a range of firsts: Accumulation of over one thousand antihydrogen atoms for a single run ¹⁵⁰; test of charge neutrality of antihydrogen at the 10^{-9} level ¹⁵¹; determination of the hyperfine splitting ¹⁵²; laser spectroscopy ¹⁵³ and measurement of the $1S - 2S$ interval with 10^{-12} level precision ¹⁵⁴; observation of the $1S - 2P$ transitions ¹⁵⁵, as well as fine structure and the Lamb shift ¹⁵⁶ (shown in Fig. 3.37). Recently, laser cooling

¹⁵⁰M. Ahmadi *et al.*, Nat. Comm. 8, 681 (2017).

¹⁵¹M. Ahmadi *et al.*, Nature 529, 373 (2016).

¹⁵²M. Ahmadi *et al.*, Nature 548, 66 (2017).

¹⁵³M. Ahmadi *et al.*, Nature 541, 506 (2017).

¹⁵⁴M. Ahmadi *et al.*, Nature 557, 71 (2018).

¹⁵⁵M. Ahmadi *et al.*, Nature 561, 211 (2018).

¹⁵⁶The ALPHA Collaboration, Nature 578, 375 (2020).

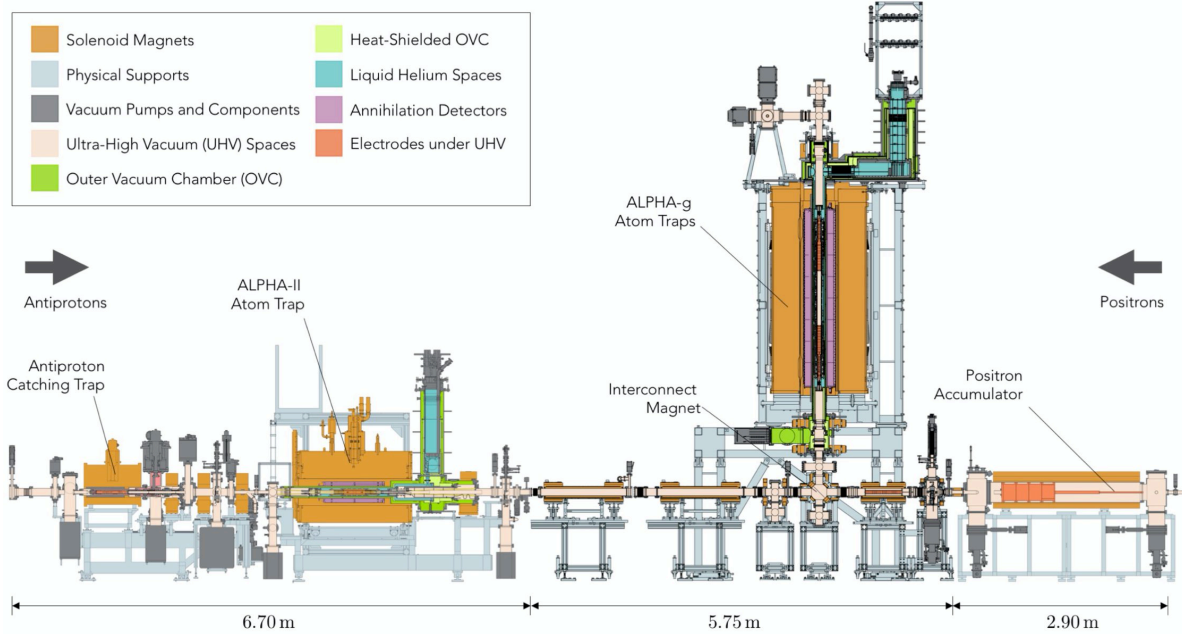

Figure 3.36: The ALPHA-2 trap for precision laser spectroscopy (left) and the vertical ALPHA-g trap for gravity and microwave studies (right) at the CERN AD facility.

of antihydrogen was demonstrated. These accomplishments open the door to a new chapter in antimatter physics where spectroscopic precisions achievable with antihydrogen will rival those of hydrogen. In terms of sensitive symmetry tests, this implies that likely not only antihydrogen, but also hydrogen spectroscopy has to increase in accuracy. The near term goal is to achieve sub-kHz (i.e., 10^{-13}) precision. ALPHA-Canada, which constitutes more than one third of the collaboration, continues to provide leadership in particle detection, spectroscopy and laser cooling.

For the coming 5 year period, emphasis will be on the new, CFI-funded, ALPHA-g apparatus (right side of Fig. 3.36, currently being readied for deployment, for the measurement of gravitational free-fall of neutral anti-matter, probing the gravitational interaction of antimatter. This device will also allow 100-fold improved hyperfine spectroscopy. As this device moves online, a next generation effort will be launched in Canada, HAICU (Hydrogen-Antihydrogen Infrastructure at Canadian Universities), which will exploit the amazing progress being made in the field of quantum sensing. In HAICU, the (anti)hydrogen atoms will be cooled to μK temperatures, several orders of magnitude colder than for the presently most precise measurements of the hydrogen spectrum, enabling substantial progress with hydrogen during offline commissioning in Canada, with the introduction of atomic fountain and atom interferometry techniques.

On the 2027-36 horizon HAICU would be deployed at CERN, where atomic fountain based measurement can be performed with antihydrogen and hydrogen in the same apparatus, greatly diminishing the potential for systematic errors. Ultimately, it might be possible to form antimatter molecules and perform a CPT test at the 10^{-17} level.

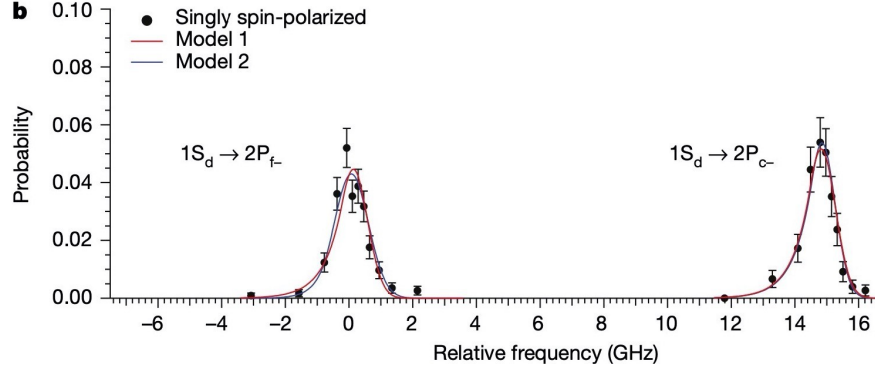

Figure 3.37: The $1S - 2P$ fine-structure spectrum of antihydrogen. Experimental data (filled circles) and fitted lineshapes for doubly spin-polarized antihydrogen samples. Taken from [The ALPHA Collaboration, Nature 578, 375 \(2020\)](#).

3.4.2.4 Nuclear decay

Unitarity of the Cabibbo-Kobayashi-Maskawa matrix (TRIUMF); Guelph, Queens, SFU, Toronto, UBC; UK, USA.

Precision measurements of the ft values for superallowed $0^+ \rightarrow 0^+$ Fermi β decays between nuclear isobaric analogue states provide demanding tests of the electroweak Standard Model. Such measurements have, for example, confirmed the conserved vector current (CVC) hypothesis at the level of 1.2×10^{-4} , set the most stringent limit on a fundamental weak scalar current coupling to left-handed neutrinos at $(0.09 \pm 0.11)\%$ of the vector strength, and, together with the Fermi coupling constant G_F from muon decay, provide the most precise determination of the $V_{ud} = G_V/G_F$ element of the Cabibbo-Kobayashi-Maskawa (CKM) quark-mixing matrix ¹⁵⁷. To determine G_V from the superallowed data, the experimental ft values must be combined with theoretical calculations of transition-dependent “outer” radiative corrections (δ_R), a transition-independent “inner” radiative correction (Δ_R^V), and nuclear structure dependent isospin-symmetry-breaking corrections (δ_C).

New calculations of radiative corrections to V_{ud} ^{158 159 160} indicate a violation of CKM unitarity of about 1×10^{-3} at 2 to 3 σ significance. As a violation of CKM unitarity would require new physics beyond the current electroweak Standard Model, all inputs must be carefully scrutinized. Figure 3.38 shows corrected Ft values for the 15 most precisely measured decays.

The TRIUMF-ISAC facility produces high-quality beams of many of the superallowed emitters with world-record intensities and hosts a suite of state-of-the-art spectrometers capable of precision measurements of all of the experimental quantities of interest in superallowed decays. These include high-precision half-life measurements through both counting with the 4pi gas proportional counter at the ISAC-I GPS facility and gamma-ray counting with GRIFFIN, high-precision branching-ratio measurements with GRIFFIN and its auxiliary detectors, high-precision Q-value measurements with the TITAN mass spectrometer, and charge-radii measurements through collinear laser spectroscopy required as input to the isospin-symmetry-breaking calculations. In superallowed half-life and branching ratio measurements, the ISAC gamma-ray group has made significant progress

¹⁵⁷J.C. Hardy and I.S. Towner, arXiv:1807.01146[nucl-ex] (2018).

¹⁵⁸C.Y Seng *et al.*, Phys. Rev. D 100, 013001 (2019).

¹⁵⁹A. Czarnecki *et al.*, Phys. Rev. D 100, 073008 (2019).

¹⁶⁰K. Shiells, Ph.D. thesis, University of Manitoba, 2020.

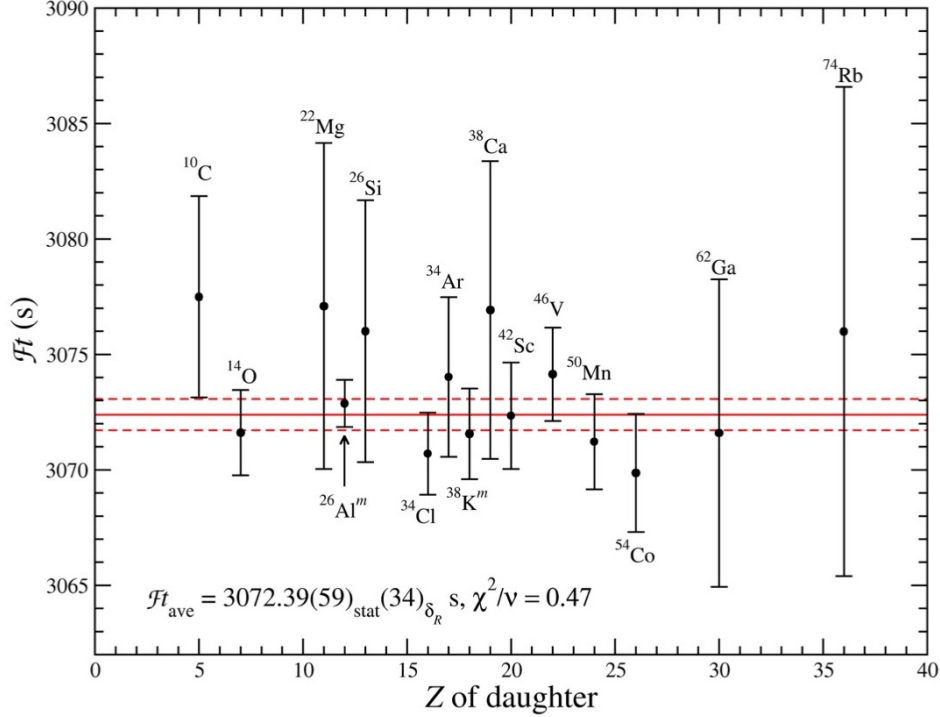

Figure 3.38: Corrected Ft values for the 15 precisely measured superallowed Fermi β decays as of June 2020. These data confirm the conserved vector current hypothesis at the level of 1.2×10^{-4} and provide the most precise determination of the V_{ud} element of the CKM quark mixing matrix.

recently: The half-life of the superallowed emitter ^{18}Ne was determined twice as precisely, demonstrating the capabilities of the new thick tape system for precision measurements of noble gas isotopes ¹⁶¹ and was also used to improve the world-average half-life for the superallowed emitter ^{22}Mg by more than a factor of 3 ¹⁶². Finally, a first superallowed half-life measurement to better than 10^{-4} was achieved with ^{10}C , with the added benefit that as the lightest such emitter, it has greatest sensitivity to possible scalar current contributions ¹⁶³

The factor of 300 – 500 gain in $\gamma - \gamma$ coincidence detection efficiency provided by GRIFFIN compared to the previous 8π spectrometer at ISAC-I has also allowed major advances in the control of the so-called “Pandemonium” problem that has plagued previous attempts at high-precision branching-ratio measurements for the heavy ($A \geq 62$) superallowed decays, as demonstrated in our recent measurement of the ^{62}Ga superallowed branching ratio to $\pm 0.0026\%$ ¹⁶⁴, a factor of 4 improvement over the previous world-average.

This highly successful, long-term, program of high-precision superallowed β decay half-life and branching ratio measurements will continue to be developed at ISAC throughout the 2022–2026 period, and beyond as new beams become available. These measurements will focus on the decays that differentiate between leading models of the isospin-symmetry-breaking corrections, namely the $N = Z - 2$ superallowed emitters ^{14}O , ^{22}Mg , ^{34}Ar , and ^{38}Ca , and the heavy $A \geq 62$ emitters between ^{62}Ga and ^{74}Rb .

¹⁶¹A.T. Laffoley *et al.*, *Phys. Rev. C* 92, 025502 (2015).

¹⁶²M.R. Dunlop *et al.*, *Phys. Rev. C* 96, 045502 (2017).

¹⁶³M.R. Dunlop *et al.*, *Phys. Rev. Lett.* 116, 172501 (2016).

¹⁶⁴A.D. MacLean *et al.*, *Phys. Rev. C* 102, 054325 (2020).

BL3: a more precise determination of the decay rate of neutrons to protons (NIST); Manitoba; USA

The BL3 experiment seeks an improvement on the precision of the neutron lifetime using the “beam” method that will resolve or confirm the long-standing discrepancy between the “beam” and “bottle” methods. The decay protons from a collimated beam of cold neutrons are trapped in the electrostatic and electromagnetic fields of a quasi-Penning trap. Periodically the fields are lowered and the protons are counted, allowing a measurement of the weak decay lifetime. The project infrastructure proposal is currently under review by the US National Science Foundation. The experiment intends to run by 2025. Near term focus of the Canadian contribution will be on simulations of the decay protons in the trap and on their way to the proton detector, and proton detector prototype testing in the University of Manitoba 30 keV refurbished mass spectrometer.

3.4.2.5 Beta neutrino correlations with trapped atoms and ions, and cold neutrons

Particle traps are ideal tools for studying correlations in β decay. The nuclear recoil escapes freely from the trap (i.e. there is no backing material), and its momentum and that of the beta can be measured, so the neutrino momentum can be determined. Furthermore, the nuclei can be spin-polarized by atomic optical pumping methods to an extremely high degree, and can be probed by atomic methods independent of the nuclear decay. Correlation experiments set stringent limits on potential scalar and tensor weak currents, and can also be used to constrain more exotic physics. Canada is a world leader in this line of research. The TRINAT facility at TRIUMF has pioneered the use of neutral atom traps to measure beta decay correlations. On the cold neutron side, two landmark measurements of parity violating asymmetries have seen their successful conclusion, $nPDGamma$ and $n3H3$, while their successor Nab , a decay correlation experiment, is gearing up to run during the coming 5 year period.

The TRINAT neutral atom trap at TRIUMF (TRIUMF); TRIUMF, UBC, Manitoba; USA.

TRINAT uses laser trapping and cooling techniques to study the decays of short-lived isotopes produced at ISAC, to search for new physics. Laser forces suspend the atoms in a mm-sized cloud in the center of a UHV chamber. The recoiling daughter nucleus of very low kinetic energy can freely escape. Its momentum, as well as that of the emitted beta particle can be precisely measured, permitting the reconstruction of the neutrino’s momentum, which cannot be measured directly. The angular distribution of the products of nuclear beta decay is sensitive to the Lorentz structure of the semileptonic currents, with discovery potential complementary to particle physics.

A recent development at TRINAT is the ability to optically pump the trapped atoms to a high degree ($> 99\%$ nuclear spin polarization and known to better than 0.1%)¹⁶⁵. This enabled the measurement of the β asymmetry in ^{37}K to 0.3% , the best such measurement in any nucleus, and in agreement with the Standard Model¹⁶⁶.

Plans for the coming years include completing the measurement of the recoil asymmetry in spin-polarized ^{37}K decay and a first time-reversal test in radiative β decay. An asymmetry accuracy of $\approx 5\%$ is expected, which is much more sensitive than constraints from other measurements such as the neutron radiative β decay branch. This period will also see the completion of a program in neutrino spectra of fission products. TRINAT has kinematically isolated the $0^- \rightarrow 0^+$ decay

¹⁶⁵B. Fenker *et al.*, *New J. Phys.* 18, 073028 (2016).

¹⁶⁶B. Fenker *et al.*, *Phys. Rev. Lett.* 120, 062502 (2018).

branch of ^{92}Rb and measured a $\beta - \nu$ correlation, consistent with expectations. The measurement will indirectly determine whether the neutrino spectrum has non-allowed components.

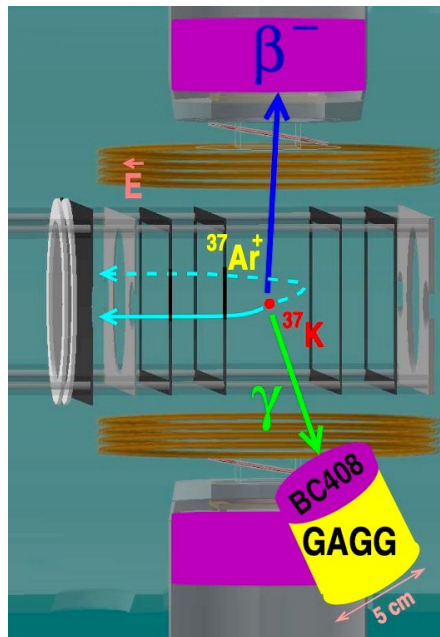

Figure 3.39: Adding γ -ray detection to TRINAT is enabling time-reversal symmetry tests in radiative β decay and isospin-breaking measurements.

A 5-fold improvement appears possible for TRINAT's previous ^{38m}K $\beta - \nu$ correlation measurement, extending into the 2027-36 period. Isospin breaking in ^{36}K will be probed, by measuring the recoil asymmetry with respect to the spin, providing a test of modern calculations needed to deduce V_{ud} from $0^+ \rightarrow 0^+$ decay. Finally, sensitivity to parity conserving, charge-symmetry breaking time-reversal violating interactions is enhanced by $10\times$ in the isospin-suppressed mirror decay of ^{45}K over other mirror decay measurements of $D\vec{I} \cdot \vec{v}_\beta \times \vec{p}_\nu$.

Nab, nPDGamma, and nHe3: decay correlation and parity-violating asymmetry experiments with cold neutrons (Oak Ridge); Manitoba, TRIUMF, Winnipeg; USA

The *Nab* experiment at the Spallation Neutron Source (SNS) at Oak Ridge is gearing up to follow in the footsteps of two efforts that recently have provided the most stringent constraints on the 6 weak nucleon-nucleon coupling constant to date. The *nPDGamma* experiment carried out the world's first measurement of parity violation in the neutron-proton system with a first nonzero observation of the corresponding asymmetry $A_{PV} = 3.0 \pm 1.4(\text{stat}) \pm 0.2(\text{sys}) \times 10^{-8}$ ¹⁶⁷. The result confirms in a simpler system measurements in ^{18}F of the smallness of the isovector versus isoscalar weak NN interaction, nicely consistent with several recent theory approaches. Likewise, the *n3He* experiment carried out the first measurement of parity-violation in the neutron- ^3He system, which is the next simplest nuclear system, aside from the technically very difficult measurements on deuterium. This measurement was a first and observed an asymmetry $A_{PV} = 1.58 \pm 0.97(\text{stat}) \pm 0.24(\text{sys}) \times 10^{-8}$ ¹⁶⁸. Future improvements of these measurements will

¹⁶⁷D. Blyth *et al.*, *Phys. Rev. Lett.* 121, 242002 (2018).

¹⁶⁸M. Gericke *et al.*, *Phys. Rev. Lett.* 125, 131803 (2020).

be technically very challenging and are a long way off, requiring the construction of new facilities, such as the European Neutron Spallation Source.

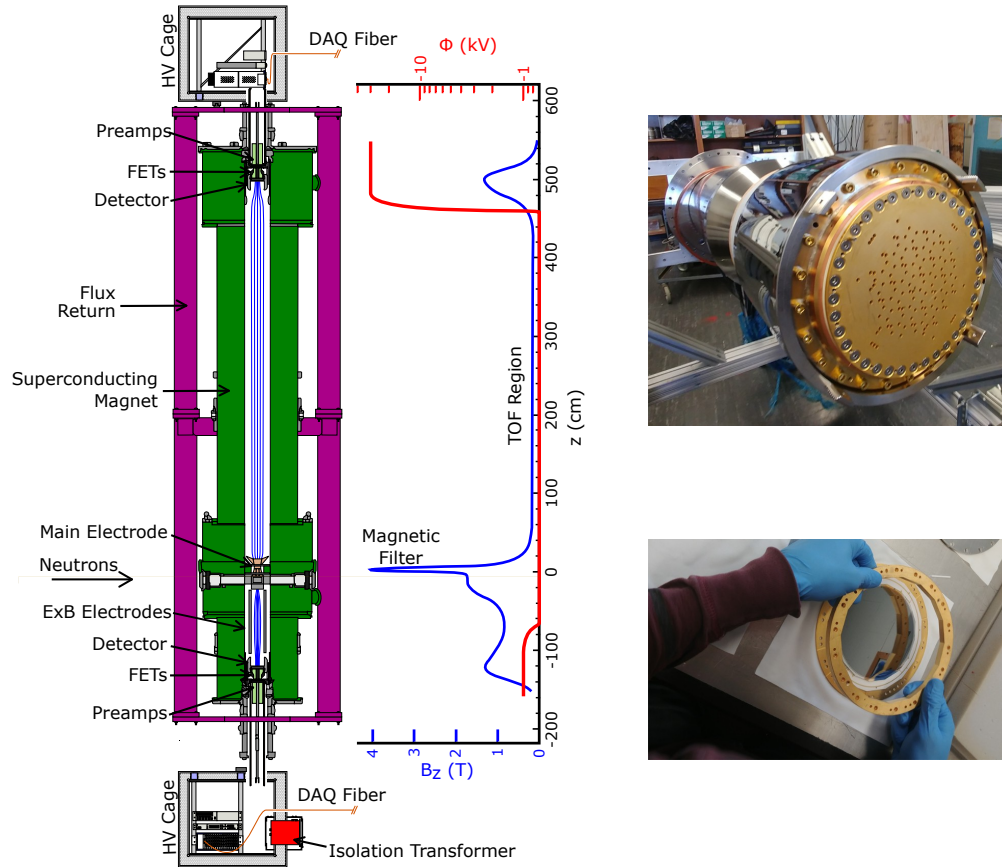

Figure 3.40: Left: Schematic illustration of the 8 meter long *Nab* spectrometer and detector assembly with electric and magnetic field configuration. Right: Assembly and testing of the *Nab* large area silicon detectors at the University of Manitoba.

The focus in the coming years will be the *Nab* experiment. It measures the correlation parameter a and the Fierz interference term b in un-polarized cold neutron beta decay. The heart of the apparatus is an ≈ 4 m tall solenoidal spectrometer with segmented Si detectors on either end to measure the energy of the decayed electrons and momentum of the decayed protons, shown on the left in Figure 3.40. The Canadian group's primary contribution to the experiment is the development of a 30 keV proton accelerator at the University of Manitoba that will be used to characterize the large area Si detectors used in the experiment (shown on the right in Figure 3.40). *Nab* will begin collecting data in 2021 and continue until 2024, after which spin-polarized cold neutrons will be used with the same apparatus to measure the neutron beta decay correlation coefficients A and B .

3.4.2.6 Neutrinos

Neutrinoless double β -decay: The search for Majorana neutrinos with nEXO (SNO-LAB) Carleton, Laurentian, McGill, Sherbrooke, TRIUMF, UBC; China, Germany, Russia, South

Africa, Switzerland, USA.

A major open question is the nature of neutrinos and how they influence the evolution of the universe. The discovery that neutrinos are not massless has been transformative in that a neutrino could have an astonishing property of being its own anti-particle. An extremely rare nuclear decay mode known as neutrinoless double beta ($0\nu\beta\beta$) decay offers the most sensitive experimental method to test for this possibility. The observation of this most exotic decay mode would provide irrefutable evidence that neutrinos are their own anti-particle and correspondingly that the symmetry of lepton number conservation is violated. Its observation would also provide strong experimental guidance for theories that go beyond the Standard Model, yielding insights into the origin of neutrino mass. In particular, if neutrinos are indeed their own antiparticles, they could not gain their mass through the interactions with Higgs particles in the same way as all other elementary particles in the Standard Model. Neutrinos with this property could also be key players in generating the observed excess of matter over anti-matter in our universe.

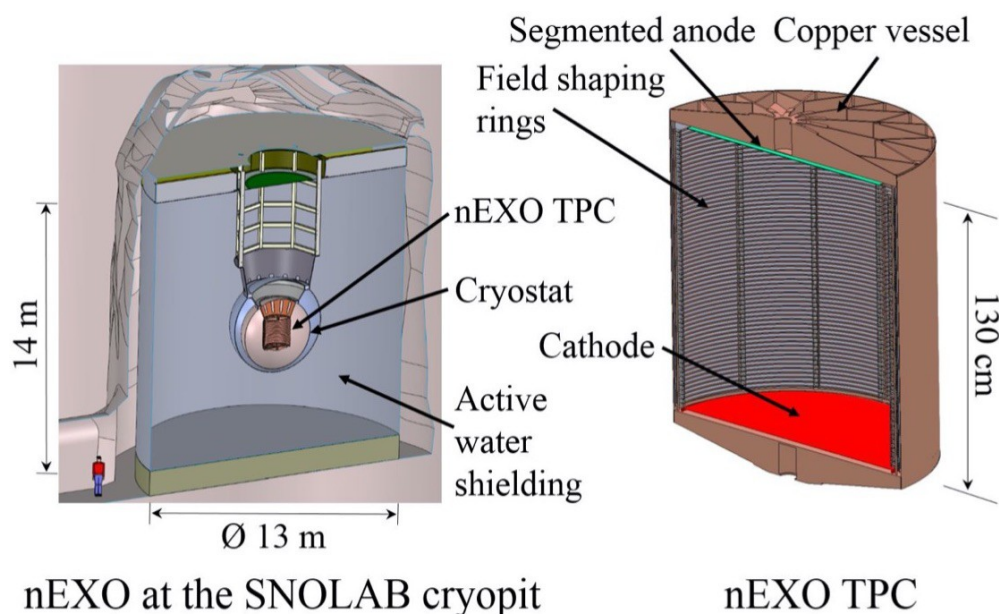

Figure 3.41: Artist rendering of the nEXO TPC (right) and its installation at the SNOLAB cryopit (left). The cryostat is submerged in a water tank, which acts as active shielding. SiPMs will be mounted between field shaping rings and detector wall.

The nEXO experiment will search for $0\nu\beta\beta$ decay in the isotope ^{136}Xe . It is the successor to EXO-200, which over the past decade observed the $2\nu\beta\beta$ in this isotope and carried out several searches for the neutrino-less mode. The goal of nEXO is to push the sensitivity by a factor of 100 or more, reaching half-lives of 10^{28} years¹⁶⁹. The optimum location for nEXO is the SNOLAB underground laboratory in Sudbury, Ontario, shown as an artist's conception in Figure 3.41. It has advantages of depth (equal very low cosmic background), extensive clean room facilities, and existing capabilities and expertise for the design, construction and operation of the experiment. With a final approval by DOE expected soon, the collaboration, which has a very substantial Canadian component with 6 involved institutions, has embarked on extensive R&D for key detector

¹⁶⁹J.B. Albert *et al.*, *Phys. Rev. C* 97, 065503 (2018).

technologies. Current Canadian contributions include the development of novel photon sensors, assembly and testing of the light-collection system, radioactive background control, an external calibration source deployment system, a water shield with active muon veto, a water purification and assaying system, and SNOLAB infrastructure, and development of low-background techniques for a future upgrade.

Commissioning is expected around 2027/28, contingent on the DOE selection process; nEXO will then take data for at least one decade to reach the 10^{28} year half-life goal.

Canadian groups constitute about 20-25% of the EXO-200 and nEXO Collaborations, and take substantial responsibilities, including chair of the EXO-200 collaboration board for the period of the last 5-year plan, serving as one of two EXO-200 analysis coordinators, and contributions to operations as part of the EXO-200 management team. Within nEXO, two Canadian PIs are Level-2 sub-systems physicists out of 11 subsystems (with the two subsystems as full Canadian responsibility), and three Canadian PIs hold L3 leadership responsibilities for subsystems in other WBSes. In parallel to the deployment of the nEXO apparatus, the Canadian team is pursuing techniques that would greatly suppress background, such as Barium tagging. In this approach, a small volume surrounding a $0\nu\beta\beta$ event is extracted from the detector and probed for the presence of a Ba-ion, an unambiguous tag for a true decay event.

BeEST: A search for keV-scale neutrinos in the electron capture decay of ${}^7\text{Be}$ using superconducting quantum sensors (TRIUMF); TRIUMF; USA

The search for sterile neutrinos is among the most promising avenues in our quest for understanding the microscopic nature of dark matter in our universe. Sterile neutrinos - unlike the active neutrinos in the Standard Model (SM) - do not interact with normal matter as they move through space, and as such are best observed via their mass-generated effects that result from momentum conservation with SM particles. The BeEST experiment (Beryllium Electron-capture in Superconducting Tunnel junctions) aims to perform the highest-sensitivity search for keV-scale sterile neutrinos to date using the electron capture decay of ${}^7\text{Be}$ implanted into superconducting quantum sensors. This work has been possible by leveraging existing state-of-the-art superconducting tunnel junction (STJ) detector technology developed at Lawrence Livermore National Laboratory (LLNL), as well as more than a decade of work at TRIUMF-ISAC for the low-energy implantation of pure ${}^7\text{Be}$ beams into thin films ¹⁷⁰. The proposed program employs momentum reconstruction in the electron capture (EC) decay of ${}^7\text{Be}$ implanted in these STJs to search for missing momentum in the nuclear recoil spectrum that would be generated by heavy neutrinos ¹⁷¹. Since the neutrino escapes the thin detector without interacting, the spectrum consists of four peaks corresponding to the energy released by the recoiling ${}^7\text{Li}$ daughter atom for different decay processes. The signature of heavy neutrinos is a small fraction of events whose recoil energy peaks are shifted to lower energies due to the missing momentum. The relative fraction of these events to the total indicates the mixing fraction with the electron neutrino.

Over the coming 5 years, BeEST will scale the experiment using existing 36- and 112-pixel detector arrays, fabricate new 128-pixel Al-based STJ detector arrays deposited on thin membranes, and develop a new target and beam purification techniques at TRIUMF-ISAC and ARIEL to reach ${}^7\text{Be}$ intensities approaching 10^{10} s^{-1} . The goal is to either find a candidate or provide exclusion limits 10,000 times more stringent than previous tests in the 5-860 keV mass region.

¹⁷⁰S. Fretwell *et al.*, *Phys. Rev. Lett.* 125, 032701 (2020).

¹⁷¹S. Friedrich *et al.*, arXiv:2010.09603 (2020).

The Canadian contribution towards optimal beryllium implantation will make use of the new CFI-funded CANREB facility, and electron-induced photofission at ARIEL.

Synergies with theory Manitoba, Memorial, TRIUMF

Fundamental symmetry measurements critically depend on nuclear, atomic, and particle physics theory to extract the underlying physics from the data. As mentioned earlier in this section, groups at Memorial and Manitoba have been active in carrying out one-loop and two-loop electroweak radiative corrections crucial for parity violating electron scattering experiments. Alberta and Manitoba are also playing a leading role in CKM unitarity tests by advancing the state-of-the-art in radiative correction calculations for V_{ud} . More information is found in [3.5.2.4](#)

In addition, recent advances in *ab initio* nuclear structure calculations by theorists at TRIUMF are starting to have impact on fundamental symmetry work, such as neutrinoless double-beta decay, permanent electric dipole moment searches, atomic parity violation (anapole moments), and beta decay. Details are presented in the following theory section, in particular in [3.5.2.6](#) and [3.5.2.7](#).

3.4.3 Beyond the next five years

A good mix of ongoing projects, efforts currently ramping up, and preparations underway for future experiments, Canada's program in fundamental symmetries is well prepared to remain world-leading beyond the immediate 5 year horizon, with a wide range of investigations leading us far into the 2030s.

The TUCAN neutron EDM experiment will run beyond 2026, with extensive data analysis, and possible upgrades. A second port at the UCN source can accommodate other measurements with ultra-cold neutrons, such as the neutron lifetime or a neutron gravitational levels experiment probing short range modifications to gravity. In this phase TUCAN will turn into a user facility seeking external proposals.

A major new effort at TRIUMF/ISAC will be precision spectroscopy with radioactive molecules, in particular as related to searches for permanent electric dipole moments. This project is currently taking shape, with the development of a beamline. After initial work on molecule formation and preparatory spectroscopy, beyond 2025, a competitive EDM search would unfold, with increasing precision over 5 years. A francium atomic fountain electron EDM experiment could be on the floor at ISAC within a few years, and reach design sensitivity by 2026, with improvements in the following years. By mid-decade, when ISAC/ARIEL have reached the capacity to deliver up to 3 radioactive beams simultaneously, the FrPNC experiment will have established the techniques to start an atomic parity violation production run. ISAC's ability to produce a wide range of Fr isotopes in large quantities and its unique expertise in Fr laser trapping naturally suggest a program based on cold molecules assembled from laser trapped Fr and other species such as Ag.

For parity-violating electron scattering, the decade from 2026 to 35 will be a very busy and productive one. In the first half, MOLLER and P2 will take data and aim for 1 % measurements of parity violating asymmetries, with analysis wrapping up in the second half, just in time for EIC-based programs in fundamental symmetries picking up.

In antimatter research, we will see the deployment of HAICU by the ALPHA collaboration, with precise, simultaneous spectroscopy of hydrogen and antihydrogen in an atomic fountain apparatus. Another goal will be the production of antimatter molecules, and prospects of CPT tests at the 10^{-17} level.

In beta decay, the long-standing program of super-allowed decay lifetime and branching ratio measurements at ISAC shows no sign of slowing down. As new beams get developed, additional cases can be measured, and systematic investigations, e.g. on isospin-symmetry breaking corrections, can be carried out. Especially in light of the recent tensions between theory and experiment for the unitarity of the CKM matrix, this will be a worthwhile endeavour. On the beta decay correlations front, the TRINAT laser trapping facility at ISAC will aim for a 5-fold improvement of the ^{38m}K beta-neutrino correlation measurements, further tightening constraints on scalar interactions. Isospin breaking in ^{36}K will help benchmark theory related to V_{ud} . At Oak Ridge, the *Nab* setup will reconfigure to measure that neutron beta decay correlation coefficients A and B .

In the neutrino sector, an approved nEXO would see commissioning in the late 20s, running then for at least a decade, pushing the sensitivity for the $0\nu\beta\beta$ half-life of ^{136}Xe to 10^{28} years, either observing $0\nu\beta\beta$ decay or setting a new limit. In parallel, the Canadian contingent will push background suppression techniques such as barium tagging.

3.4.4 Summary

The Canadian nuclear physics community is involved, and in many cases is heading, world-leading efforts in the area of fundamental symmetries. The record over past decade has been excellent, and several major, exciting new initiatives will enter the stage over the next five years, ensuring Canadian leadership well beyond a 10-year horizon. The program is remarkably balanced in terms of work at Canada's own world-class facilities, TRIUMF and SNOLAB, versus off-shore projects. The scientific coverage is amazingly diverse, addressing the pressing questions in the field. Research in fundamental symmetries of nature is undoubtedly one of the jewels in Canadian science.

3.5 Nuclear Theory

3.5.1 Overview

Perhaps the most complicated quantum systems in the universe, atomic nuclei are intimately connected to some of the most profound questions in science, such as the nature of neutrinos and dark matter, the role of fundamental symmetries, the inner workings of neutron stars, and the nucleosynthesis pathways that lead to the observed abundances of elements. Striving to answer the most fundamental question in our Universe, theorists work on projects ranging from developing a predictive *ab-initio* theory of nuclear structure and nuclear reactions to phenomenological approaches guided by empirical data in close collaboration with experiment, and on everything in between.

Progress in nuclear theory, both from a fundamental point of view, and in its connection with experimental measurements, has therefore to proceed on several fronts at once, and it is thus imperative to maintain a vibrant and diverse theoretical program.

The main challenge of nuclear theory is a non-conformal nature of quantum chromodynamics (QCD), so the nuclear interaction appears to be quite different at different energy scales. At high energies, most QCD calculations are amenable to perturbative techniques. However, at the energy scale where the details of nuclear structure are relevant, QCD is non-perturbative. Lattice techniques, although greatly improved in the recent years, still can not solve all problems in hadronic physics. However, there has been remarkable recent progress in effective theories which preserve the important symmetries of the underlying fundamental theory, and yet are applicable in a given energy interval. However, for a large class of problems, phenomenological approaches to methods and modelling are required.

Some of the world leaders in nuclear theory, in fields such as *ab-initio* nuclear structure, relativistic heavy ion collisions, and precision calculations for low-energy measurements are already based in Canada, and there is a great opportunity to further strengthen and grow these programs with strategic investment in HQP who can accelerate the efforts of these groups and take full advantage of collaboration with Canadian experimentalists at new or recently-upgraded facilities.

3.5.2 The Canadian program

Canadian theorists have kept at the forefront of the rapidly developing trends in nuclear and hadronic theory with many examples of close involvement in the major breakthroughs of the field. The Canadian effort is distributed in several groups coast-to-coast, from British Columbia to Newfoundland and Labrador, building intellectual capacity in their regions and pursuing a broad range of initiatives. The advancement of nuclear physics is strongly dependent on interplay between theory and experiment, and many Canadian research programs are the excellent examples of such successful collaboration. Theory input is indispensable for many experimental programs, especially for the quickly-developing precision frontier which can reach for new physics at TeV scale. Canadian theorists identify promising future directions for the experimental programs in Canada and off-shore, participate in experimental proposals, develop new computational methodology, help to interpret the experimental data, and educate the future generation of researchers in both theory and experiment. There is a very active Canadian community pursuing a plethora of research topics on the theoretical aspects, especially hot and cold QCD and hadronic systems. Importantly, calculations involving QCD appear not only in nuclear physics, but in all computations and estimates that rely on the Standard Model such as calculating decay modes of the Higgs boson. In several cases, the overall precision of the measurements is often determined by our knowledge of

the strong interaction or relevant radiative corrections. The Canadian community is also spearheading developments for the capability to theoretically describe light- and medium-mass nuclei as systems of nucleons interacting by forces rooted in the fundamental theory of strong interactions. Using a low-energy expansion of QCD, namely chiral effective field theory (χ EFT), one can derive forces among nucleons and their interactions with external probes in a consistent way. Studies in light- and medium-mass nuclei and nucleon polarizabilities are crucial to test such a theory and these initiatives are pursued hand-in-hand with experiments performed at TRIUMF-ISAC, JLab and elsewhere. Nuclear Theory research represents a great opportunity to reinforce and advance an established Canadian strength at the forefront of modern research. In this section we highlight some Canadian activity in the theory of atomic, nuclear and particle physics.

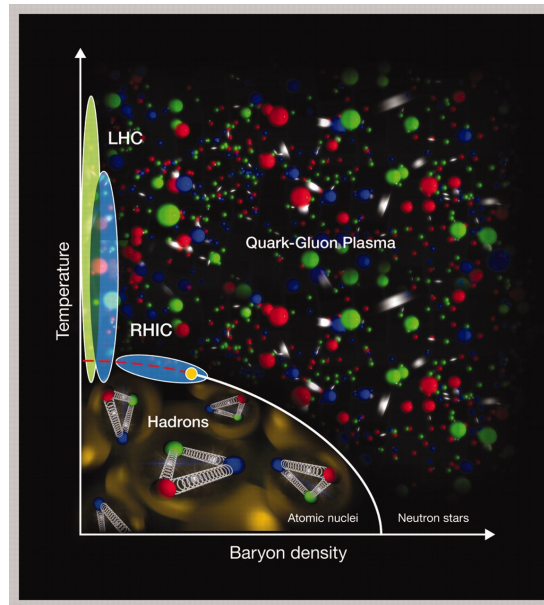

Figure 3.42: The conjectured phase diagram of quantum chromodynamics. Details are given in the text. This figure is from [B. V. Jacak and B. Müller, *Science* 337, 310 (2012).]

3.5.2.1 QCD under extreme conditions

The collision of large nuclei at high energy is a practical way of creating strongly-interacting systems at high temperatures and at high densities. These conditions prevailed a few microseconds after the Big Bang, and several experimental facilities around the world have been devoted to the study of “extreme QCD”, with vigorous experimental programs at RHIC and at the LHC, at FAIR/GSI, in Darmstadt, Germany, and at NICA, in Dubna, Russia. Apart from the reproduction of the physical environment that existed in the early Universe, the many-body nature of finite-temperature QCD is still not that well known and many questions remain. For example: What is the nature of the QCD phase diagram? Are there critical points? What are the bulk properties of the quark-gluon plasma? Some of those questions have immediate relevance not only for hadronic physics, and answering them may also very well influence our understanding of the physics of dense stellar objects such as neutron stars, for the equilibrium aspects, and also supernovae explosions, for the non-equilibrium features.

A prominent research program at McGill University aims to understand QCD under extreme conditions, in and out of equilibrium. The success of modelling heavy-ion collisions with relativistic hydrodynamics was spectacularly realized at RHIC and finally confirmed by heavy-ion runs at the LHC ¹⁷². A part of McGill research program is a quantitative characterization of the quark-gluon plasma, and a search for its transport coefficients. Those can be obtained by taking the static, long wavelength limits of spectral densities, obtained from current-current correlators. Those correlators can be estimated in models, or obtained from calculations made using lattice QCD. In parallel, one may extract those from phenomenological studies of flow variables measured in heavy-ion collisions, interpreted through fluid dynamical simulations; and McGill group is pursuing both strategies ¹⁷³.

Another means to characterize the QGP is tomography: one uses a standard probe such as photons, real and virtual, and QCD jets, and then measure deviations from expected behaviour to be attributed to in-medium effects.

MARTINI ¹⁷⁴ is an approach which evolves entire parton showers in a relativistic hydrodynamics background (once the system has hydrodynamized). With this evolved tool which includes collisional and radiative energy loss, the quenching of QCD jets and the emission of photons can be treated consistently and thus represent complementary observables. A version of MARTINI where the treatment of QCD jet energy-loss was reformulated in coordinate space through the Light Cone Path Integral formalism ¹⁷⁵ enables a finite size (or formation time) modification which is important at the LHC ¹⁷⁶. The improved theory will be used to calculate the effect of jet energy-loss, of jet sub-structure, of jets fragmenting into photons, and of photon production by jets interacting with the medium. From this privileged position, the group can tackle correlation-observables such as photon- and dilepton-tagged jets at the LHC, which will reveal additional facets of jet energy loss. Finally, much recent progress in jet morphology analyses ¹⁷⁷ raise the tantalizing possibility of establishing a reference (through photon tagging) to test different scenarios of jet-medium interactions. The photon tagging constitutes a trigger and the differential jet shape $\rho(r)$ of the tagged jets will be analyzed to reveal energy loss and other in-medium interactions. The exploration of jet physics is the main focus of sPHENIX, an experiment currently in construction at RHIC.

A fundamental question in all studies of the many-body effects observed in high energy heavy ion collisions is whether the observed correlations develop dynamically or are already present in the initial states. A new approach has recently been constructed ¹⁷⁸ which properly takes into account the evolution in full 3-dimensional space. An exploration of the consequences of this full 3+1D IP-Glasma model in conjunction with the hydrodynamics model will involve the vast amount of new data being produced at the LHC, which will continue to run its heavy-ion program in parallel with its pp agenda. Importantly, the physics of the IP-Glasma relies on that of *saturation*: the scale at which the non-linearities of the gluon field manifest themselves. The exploration of the *saturation regime* is a central theme of the recently approved EIC, which will push our study of QCD to new frontiers.

¹⁷²P. Romatschke and U. Romatschke, *Relativistic Fluid Dynamics In and Out of Equilibrium*, Cambridge, UK: Univ. Pr. (2019).

¹⁷³B. Schenke, S. Jeon, and C. Gale, *Phys. Rev. C* 82, 014903 (2010).

¹⁷⁴B. Schenke, C. Gale and S. Jeon, *Phys. Rev. C* 80, 054913 (2009)

¹⁷⁵S. Caron-Huot and C. Gale, *Phys. Rev. C* 82, 064902 (2010)

¹⁷⁶C. Park, C. Shen, S. Jeon and C. Gale, *Nucl. Part. Phys. Proc.* 289-290, 289 (2017)

¹⁷⁷M. Connors, C. Nattrass, R. Reed and S. Salur, *Rev. Mod. Phys.* 90, 025005 (2018)

¹⁷⁸Scott McDonald, Sangyong Jeon, Charles Gale. *Nucl. Phys. A*982 239 (2019)

3.5.2.2 Lattice field theory for QCD and beyond

A great deal of theoretical effort is devoted to calculate bound states masses and transition matrix elements from a variety of approaches. Notably, Canadians have been pursuing the use of potential models and of lattice QCD techniques to calculate these quantities for states involving heavy quarks accessible to the Belle II, LHCb, and GlueX experiments. The meson results highlighted here were obtained with an approach which includes a relativistic kinetic energy term, together with a Lorentz vector one-gluon-exchange interaction, with a QCD-motivated running coupling constant, and a Lorentz scalar linear confining interaction.

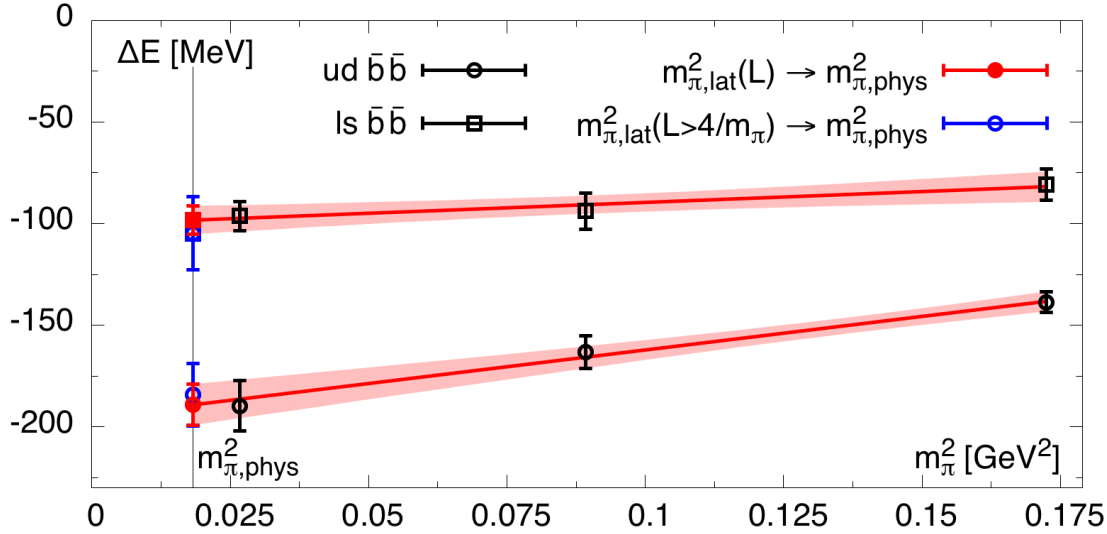

Figure 3.43: Binding energies for the $ud\bar{b}\bar{b}$ and $us\bar{b}\bar{b}$ tetraquarks obtained from lattice QCD for a range of pion masses. The physical pion mass is toward the left of the graph, marked by a vertical line. This figure is from Francis, Hudspith, Lewis and Maltman, Physical Review Letters 118, 142001 (2017).

Potential models represent a powerful and elegant non-perturbative technique to obtain bound state masses and decay transition rates. A first-principles approach to these results is that of lattice QCD. The Canadian lattice community is obtaining non-perturbative results to compare with experimental measurements, or even making predictions for the results of observations yet to be performed. During the past few years, lattice QCD has confirmed the existence of a tetraquark with valence content $ud\bar{b}\bar{b}$ that is stable under both strong and electromagnetic interactions, decaying only weakly. The first direct lattice QCD calculation was performed in Canada ¹⁷⁹. For decades, textbooks have told us that hadrons exist as mesons (with two quarks) or baryons (with three quarks), so it is very exciting to discover that a tetraquark (with four quarks) also exists within QCD. Several experiments around the world have been observing other tetraquark candidates, and future experiments will search for the $ud\bar{b}\bar{b}$ tetraquark which is special by having only weak decays. Meanwhile, future lattice QCD calculations will address the list of other tetraquark candidates. Currently, the research group at York University is using lattice field theory to advance knowledge in three major directions. First, building on their experience with conventional hadrons,

¹⁷⁹A. Francis, R.J. Hudspith, R. Lewis, K. Maltman, Phys. Rev. Lett. 118, 142001 (2017)

the group is now performing calculations of exotic hadrons. Although exotic candidates have been observed at many experimental facilities around the world, there is no consensus on a theoretical understanding. Lattice QCD provides access to quantitative results from first-principles theory, at least for quantities that today’s lattice infrastructure can handle. At York University, the recent emphasis has been on doubly heavy tetraquarks ¹⁸⁰. In addition, the group is using lattice methods to study a theory of dark particles with a dark force that resembles the known theory of quarks and gluons ¹⁸¹. And, an exciting new development, now that prototype quantum computers have been built in several labs around the world, it is time to learn how to write efficient algorithms for the research applications that have the greatest need for a quantum computer, and lattice gauge theory is a prime candidate. On classical computers, lattice code involves Monte Carlo calculations in Euclidean spacetime, which accurately describe the properties of motionless particles but unfortunately cannot provide access to the movement of particles through real (Minkowski) time. Avoiding the Monte Carlo approach is not feasible on classical computers, but it might be possible on quantum computers, greatly advancing lattice gauge theory.

3.5.2.3 Hadron structure with LFHQCD, ChPT and QCD sum rules

Some of possible ways to tackling the challenges of QCD is with approximate analytical methods such as light-front holographic quantum chromodynamics (LFHQCD), Chiral Perturbation Theory (ChPT) and QCD sum-rule studies. The Atlantic theory group, lead by four faculty members, at Acadia in Nova Scotia, Mount Allison in New Brunswick, and Memorial University of Newfoundland (MUN) in Newfoundland and Labrador, is developing an integrated approach to investigating hadron structure based LFHQCD and ChPT while providing joined training opportunities to HQP in their region. Dr. Barkanova’s move to MUN in 2017 with her position at Acadia filled by Dr. Sandapen not only helped to strengthen the graduate program in theoretical subatomic physics at MUN, the only one in the Atlantic Canada, but also to increase the diversity of the group and to maintain primary-undergraduate Acadia as an excellent “feeder” school for graduate programs in both theory and experiment, in nuclear, particle and astrophysics. Immigrants from four different countries, the faculty members of the Atlantic Canada group can now combine their networks to recruit HQP in Mauritius, Iran, Pakistan, India, China, Eastern Europe, Russia and Germany, and train a significant number of undergraduate students while expanding a graduate program at MUN and contributing to science outreach for Black and Indigenous youth. The group works in both nuclear and particle physics theory, with a part of their combined expertise applicable to the low-energy hadronic physics such as calculations up to two-loops in perturbative expansion of specific quantum field framework with the development of corresponding computer algebra tools applicable to a broad spectrum of the processes ¹⁸².

LFHQCD, an approximate gravity dual to light-front QCD, is a realization of the Maldacena Conjecture which refers to a duality between a strongly-coupled QFT in physical spacetime and a weakly-coupled gravitational theory in a higher dimensional spacetime, and can be used to predict the elastic/transition form factors, radii and decay constants for vector and pseudoscalar mesons using the phenomenological extension of LFHQCD. The predictions for the pion TMDs can be tested through pion-induced Drell-Yan process at COMPASS, and predictions for pion/kaon EM form factors (see Fig. 3.44) can be accessible by the future experiments at JLab and the EIC.

¹⁸⁰A. Francis, R.J. Hudspith, R. Lewis, K. Maltman, *Phys. Rev. Lett.* 118, 142001 (2017) and *Phys. Rev. D* 99, 054505 (2019)

¹⁸¹A. Francis, R.J. Hudspith, R. Lewis, S. Tulin, *J. High Energ. Phys.* 2018, 118 (2018)

¹⁸²A. Alekseev et al, *Phys. Rev. D.* 101, 053003 (2020); A. Afanasev et al, *Phys. Rev. D.* 88, 053008 (2013)

One of the recent group’s finding, for example, is that light pseudoscalar and vector mesons share a universal holographic light-front wavefunction, modified by dynamical spin effects ¹⁸³. The group also propose the spin structure to augment the LFWFs in order to achieve agreement with the experimental data using a universal confinement mass scale and provide the predictions for rare $B_s \rightarrow \phi\mu^+\mu^-$ decay rate ¹⁸⁴.

Another set of projects include evaluation of the spin-independent electric and magnetic dynamical polarizabilities for the lowest in mass SU(3) octet of baryons ¹⁸⁵ and spin-dependent dynamical polarizabilities ¹⁸⁶, with work on including decuplet of resonances in all electric, magnetic and spin-dependent polarizabilities now in progress. Drs. Aleksejevs and Barkanova are also involved in feasibility studies of experiments and co-author proposals such as measuring the neutral pion polarizability proposal submitted to PAC 48 at JLab in 2020.

Both LFHQCD and ChPT can predict form factors for the proton and charged pion, so the group is also investigating the link between ChPT and LFHQCD in the low-energy range. With LFHQCD studies of the pion form factor, radius, decay constant and photon-to-pion transition amplitude extending into the kinematical regime of ChPT, it became possible to link LFHQCD and ChPT in SU(2) and SU(3) leading to a new range of opportunities in this challenging field.

Although the conventional quark model represents the simplest combinations of quarks that can form colour singlets, there is a rich range of other colour-singlet exotic structures such as gluonium (consisting entirely of gluons), hybrids (a conventional hadron combined with gluonic content), and multi-quark states such as four-quark mesons and pentaquark baryons. A related approach currently under investigation by Dr. Steele at the Subatomic Physics Institute at the University of Saskatchewan (SPIN) is theoretical studies of mass spectrum of exotic hadrons beyond the conventional quark model with QCD sum-rules ^{187 188}.

With two theorists (Drs. Steele and Bick) and three experimentalists (Drs. Boland, Pywell and Rangacharyulu), the subatomic physics research group at SPIN has the critical mass to recruit new members and to maintain expertise in advanced quantum mechanics, QED, accelerator physics, and physics relevant for the Canadian Light Source, and to provide excellent career opportunities for their students in the areas covered by SPIN.

3.5.2.4 Precision studies with electromagnetic probes

One way to obtain access to physics at multi-TeV scales is with high-precision electroweak experiments such as parity-violating Moller scattering, e^+e^- collisions or electron-nucleon scattering. Although these low-energy experiments tend to be less expensive than experiments at the high-energy colliders, they are more model-dependent and require significant theoretical input, at two-loop (next-to-next leading order (NNLO) and in some cases beyond. The low-energy sector is not as well served as the LHC, and there are no ready-to-use routines available for complete calculation of electroweak radiative corrections. The main challenge is that, for electroweak processes, the full two-loop calculations face dramatic complications due to massive vector bosons in the two-loops integrals, and thus require a new set of analytical tools.

¹⁸³M. Ahmady et al, *Phys. Rev. D* 98, 034010 (2018)

¹⁸⁴M. Ahmady et al, *Phys. Rev. D* 95, 074008 (2017); M. Ahmady et al, *Phys. Rev. D* 100, 113005 (2019)

¹⁸⁵A. Aleksejevs et al, *J.Phys. G*38, 035004 (2011)

¹⁸⁶A. Aleksejevs et al, *PoS ICHEP2012* 469 (2013)

¹⁸⁷J. Ho, R. Berg, T. G. Steele, Wei Chen, and D. Harnett, *Phys. Rev. D* 100, 034012 (2019)

¹⁸⁸J. Ho, R. Berg, T. G. Steele, Wei Chen, and D. Harnett, *Phys. Rev. D* 98, 096020 (2018)

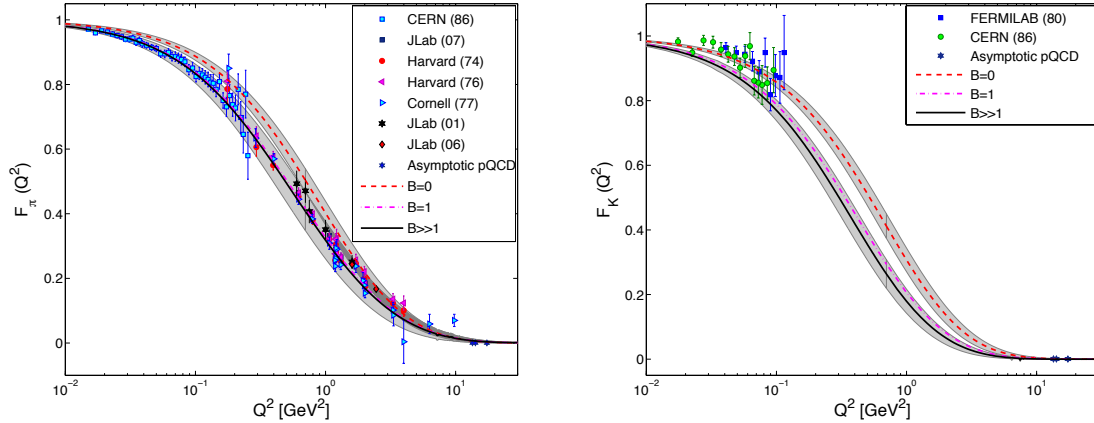

Figure 3.44: Electromagnetic form factor for pion (Left graph) and kaon (right graph) predicted by holographic QCD given for three different values of the dynamical spin parameter (B) and compared with experimental data.

At Memorial University of Newfoundland, the electroweak precision research program is focused in two major directions: development of advanced methods for calculations of extensive sets of Feynman diagrams at many-loop level and applications of these methods to the specific kinematic conditions of various experiments. In other words, the group works on building and applying computational models for multi-loop theory input specifically required by electroweak precision frontier in the searches of physics beyond the Standard Model. In many cases, the same methodology is applicable for low-energy hadronic physics calculations, discussed in Section X. The recently-developed dispersive sub-loop insertion approach¹⁸⁹ can be used to effectively reduce two-loop calculations to one-loop with an additional dispersive propagator. The approach is algorithmic and can be applied to the processes with mixed masses in the loop integrals, which is an essential component of any Beyond the Standard Model (BSM) searches, electroweak theories, and low-energy hadronic physics.

Probes involving electromagnetic and electroweak interactions can also be instrumental for understanding the fundamental properties of nucleons and of nuclei. Although in purely-leptonic processes such as Moller scattering and e^+e^- collisions the main challenge in multi-loop radiative corrections, for the electron-nucleon scattering these need to be complimented by the equally-vital one-loop corrections accounting for the hadronic effects.

In the electromagnetic sector, calculations of two-photon exchange (TPE) radiative corrections have been instrumental in resolving the discrepancy between measurements of electron-nucleon scattering form factors using Rosenbluth and polarization-transfer techniques, in making progress in understanding the proton radius problem, and in the interpretation of other precision measurements in electron scattering. Low-energy experiments in atomic parity-violation and in parity-violating electron-proton scattering have the potential to give constraints on new physics, provided that radiative corrections, especially the critical hadronic radiative corrections, are understood. A major component of the theoretical research program lead by Dr. Blunden at the University of Manitoba is aimed at unravelling these hadronic contributions and their associated uncertainties through the use of dispersion relations based on data, covering both the deep-inelastic regime as well as nucleon

¹⁸⁹A. Aleksejevs, *Phys. Rev. D* 98, 036021 (2018), A. Aleksejevs et al, arXiv:1905.07936

resonances. The dispersive analysis avoids off-shell uncertainties inherent in traditional approaches based on direct evaluation of loop diagrams, and guarantees the correct unitary behavior in the high energy limit. For example, ¹⁹⁰ examines the two-photon exchange corrections to elastic electron-proton scattering within a dispersive approach, including contributions from both nucleon and delta intermediate states, and ¹⁹¹ includes contributions from hadronic $J^P = 1/2^\pm$ and $3/2^\pm$ resonant intermediate states below 1.8 GeV.

3.5.2.5 Nuclear many-body problem and astrophysical signatures

With the addition of Dr. Caballero to Dr. Gezerlis, the nuclear theory effort is starting to form a hub at the University of Guelph, aiming to provide answers to overarching questions related to nuclear forces, novel states in nuclei and matter, as well as the behaviour of matter at thermodynamic extremes found in neutron stars, their mergers, accretion disks around black holes, and supernovae.

A major goal is to connect nuclear many-body theory with experiment, nuclear-force theories, cold-atom studies, as well as the investigation of compact stars. The work is heavily computational involving both qualitative and *ab-initio* approaches and is touching on few-body physics, nuclear structure, nuclear astrophysics, and the interface with atomic physics. The aim is to predict multi-messenger signals that in juxtaposition with observations will shed light into the structure of nuclear matter, the nature of stellar explosions and the synthesis of elements via r- and rp-processes, as well as provide theoretical input to experimental nuclear searches.

In addition to traditional phenomenological many-body approaches, in the Guelph group employs several *ab-initio* many-body methods, most of which can be described as Quantum Monte Carlo (QMC) non-perturbative simulations.

The main research findings can be categorized as follows: (a) the use of local chiral EFT in light nuclei and neutron matter¹⁹², (b) novel developments in first-principles or mean-field techniques¹⁹³, (c) the use of *ab-initio* methods to constrain selected aspects of more phenomenological approaches¹⁹⁴, and (d) the application of techniques developed for nuclear theory to systems of ultracold atoms¹⁹⁵. As seen already in this list, a main strength of our work is the ability to work at interfaces, whether between different theories (*ab-initio* vs phenomenology) or between different physical systems (neutron stars vs cold atoms).

The work is complementary to the efforts of the TRIUMF Theory group, since both groups employ chiral Effective Field Theory (EFT) interactions which are then used in different few- and many-nucleon frameworks.

The goal of Guelph's program dedicated to astrophysical signatures is to build a consistent theoretical framework to predict multi-messenger observations. The predictions are planned to include, among others, elemental abundances and neutrino counts, and will help constrain nuclear interactions and the nuclear matter equation of state, offer limits on the detection of neutrinos in the Galaxy and at cosmological distances, and provide input to numerical relativity simulations and experimental searches.

¹⁹⁰P.G. Blunden and W. Melnitchouk, Phys. Rev. C 95, 065209 (2017).

¹⁹¹J. Ahmed, P.G. Blunden, W. Melnitchouk, arXiv: 2006.12543

¹⁹²J.E. Lynn *et al.*, Phys. Rev. Lett. 116, 062501 (2016).

¹⁹³E. Rrapaj, A. O. Macchiavelli, and A. Gezerlis, Phys. Rev. C 99, 014321 (2019).

¹⁹⁴M. Buraczynski and A. Gezerlis, Phys. Rev. Lett. 116, 152501 (2016); M. Buraczynski, N. Ismail, and A. Gezerlis, Phys. Rev. Lett. 122, 152701 (2019).

¹⁹⁵T. Zielinski, B. Ross, and A. Gezerlis, Phys. Rev. A 101, 033601 (2020).

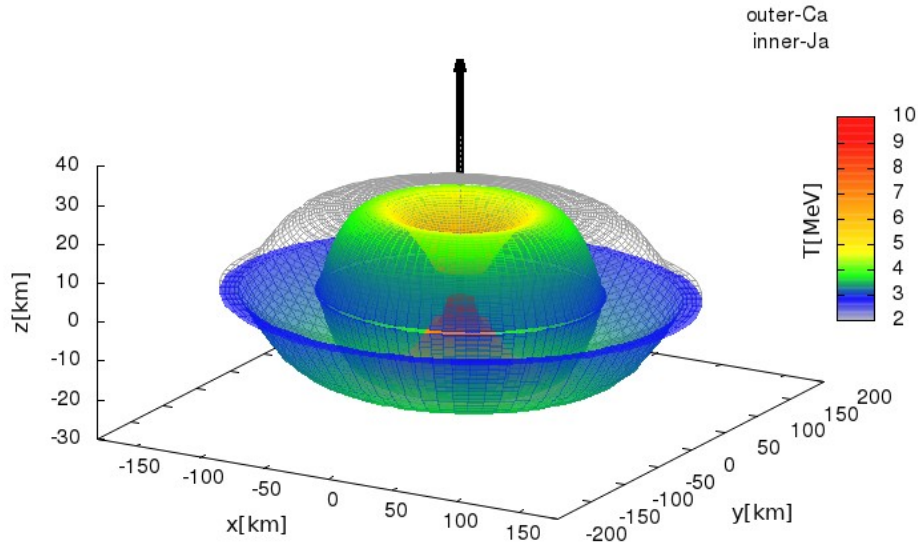

Figure 3.45: Electron antineutrino surfaces for a steady-state model Ca with constant accretion rate $3M_{\odot}/s$ (outer) and dynamical torus Ja (inner). The observer is on the symmetry axis of the disk. The upper-half of the Ca neutrino surface is shown with lines to allow visualization of the Ja neutrino surface. The color scale indicates the local temperature at the antineutrino surface (Schilbach, T. S. H., Caballero, O. L., & McLaughlin, G. C. Phys. Rev. D 100, 043008 (2019)).

This program is building on the previous work on the role of black hole spin and the observer’s inclination, for distant detection of black hole accretion disks¹⁹⁶, the detection of the relic neutrino background from accretion disks around black holes¹⁹⁷ (see Fig. 3.45), and multi-messenger signals from neutron star mergers¹⁹⁸. On the accreting neutron stars front, progress was made on the understanding of the impact of degeneracy on neutron capture rates in accreting neutron stars¹⁹⁹.

The Guelph’s nuclear-astro efforts are complementary to experimental research carried out at TRIUMF, and the neutrino program is aligned with the research goals of SNOLAB.

3.5.2.6 Ab-initio nuclear theory and applications

Weakly bound or even unbound exotic nuclei produced at rare isotopes facilities like TRIUMF can only be understood using methods that unify the description of both bound and unbound states.

¹⁹⁶O.L. Caballero, T. Zielinski, G.C. McLaughlin, and R. Surman, Phys. Rev. D 93, 123015 (2016).

¹⁹⁷T.S.H. Schilbach, O.L. Caballero, and G.C. McLaughlin, Phys. Rev. D 100, 043008 (2019).

¹⁹⁸C. Palenzuela *et al.*, Phys. Rev. D 92, 044045 (2015); L. Lehner *et al.*, Class. Quant. Grav. 33, 184002 (2016).

¹⁹⁹B. Knight and L. Caballero, Universe 5(1), 36 (2019); Knight *et al.*, J. Phys. Conf. Ser. 1078, 012012 (2018).

One of the goals of TRIUMF theory group is to develop a predictive *ab-initio* theory of nuclear structure and nuclear reactions for light and medium mass nuclei. The research team lead by Dr. Navratil combines an *ab-initio* nuclear structure approach capable to describe bound states of nuclei with a microscopic cluster method developed to describe reactions of nuclear clusters. The resulting method called the no-core shell model continuum (NCSMC) ²⁰⁰ provides a unified description of both bound and unbound nuclear states starting from inter-nucleon interactions among protons and neutrons with the only input coming from nucleon-nucleon and three-nucleon interactions derived within the chiral Effective Field Theory. The reacting system is described using a basis expansion with two key components: one describing all nucleons close together, forming the composite nucleus, and a second one describing the separated clusters. The goals include investigations of reactions important for astrophysics, including radiative capture reactions such as (p, γ) , (n, γ) and (α, γ) , the charge exchange and transfer reactions involving α particles, i.e., (α, n) , (α, p) .

Another focus of applications of *ab-initio* NCSMC and NCSM (a simplified version applicable to bound states only) is on interpretation of precision experiments testing fundamental symmetries and physics beyond the Standard Model. Examples include the determination of the v_{ud} matrix element of the CKM matrix and its unitarity tests, neutrinoless double beta decay experiments, as well as searches for nuclear electric dipole moments. Similarly, atomic and molecular parity-violating experiments require support from nuclear theory in calculations of nuclear structure contributions to anapole moments.

Recent highlights of advanced NCSMC applications with chiral 3N forces include a paper on the polarized Deuterium-Tritium fusion in Nature Communications ²⁰¹, a study of the halo nucleus ^{11}Be ²⁰² and the ^{10}C scattering on proton ²⁰³ measured at TRIUMF IRIS facility (see Fig. 1.1).

The project is aligned with TRIUMF ISAC/ARIEL program and relates to the TRIUMF astrophysics group project “Nucleosynthesis and Nuclear Energy Release from the Early Universe to the Stars.” It also complements the project by Dr. Holt (TRIUMF) on *ab-initio* investigations of medium mass nuclei within the In-Medium SRG method and, to some extent, projects by Dr. Gezerlis (Guelph).

For Dr. Holt, the central focus is to advance his many-body approach, the valence-space formulation of the in-medium similarity renormalization group (VS-IMSRG), which can be thought of as an *ab-initio* shell model approach to atoms and nuclei, using the latest two and three nucleon forces developed by the community. In terms of nuclear structure, this novel approach will soon allow TRIUMF team to reach the heaviest region of the nuclear chart and predict the neutron skin of ^{208}Pb as well as explore the superheavy region and search for a potential island of stability. The plan is also to investigate the structure of exotic nuclei, extending the predictions for the nuclear driplines and evolution of magic numbers to the heavy region of nuclei.

Among the fundamental questions related to nuclear-weak physics, the most prominent are calculations of the nuclear matrix element for neutrinoless double beta decay and WIMP-nucleus structure functions for dark matter direct detection searches. Both processes are now implemented into the VS-IMSRG framework with results up to Ge, and planned extension to the vitally important Xe region soon.

Of course, both atomic and subatomic theory are vital to interpret searches for violations of fundamental symmetries in the universe. The TRIUMF team is currently developing both atomic

²⁰⁰S. Baroni, P. Navratil, and S. Quaglioni, Phys. Rev. Lett. 110, 022505 (2013) and Phys. Rev. C 87, 034326 (2013); P. Navratil, S. Quaglioni, G. Hupin, C. Romero-Redondo, A. Calci, Physica Scripta 91, 053002 (2016).

²⁰¹G. Hupin, S. Quaglioni, and P. Navratil, Nat. Comm. 10, 351 (2019).

²⁰²A. Calci, P. Navratil, R. Roth, J. Dohet-Eraly, S. Quaglioni, G. Hupin, Phys. Rev. Lett. 117, 242501 (2016).

²⁰³A. Kumar, R. Kanungo, A. Calci, P. Navratil, et al., Phys. Rev. Lett. 118, 262502 (2017).

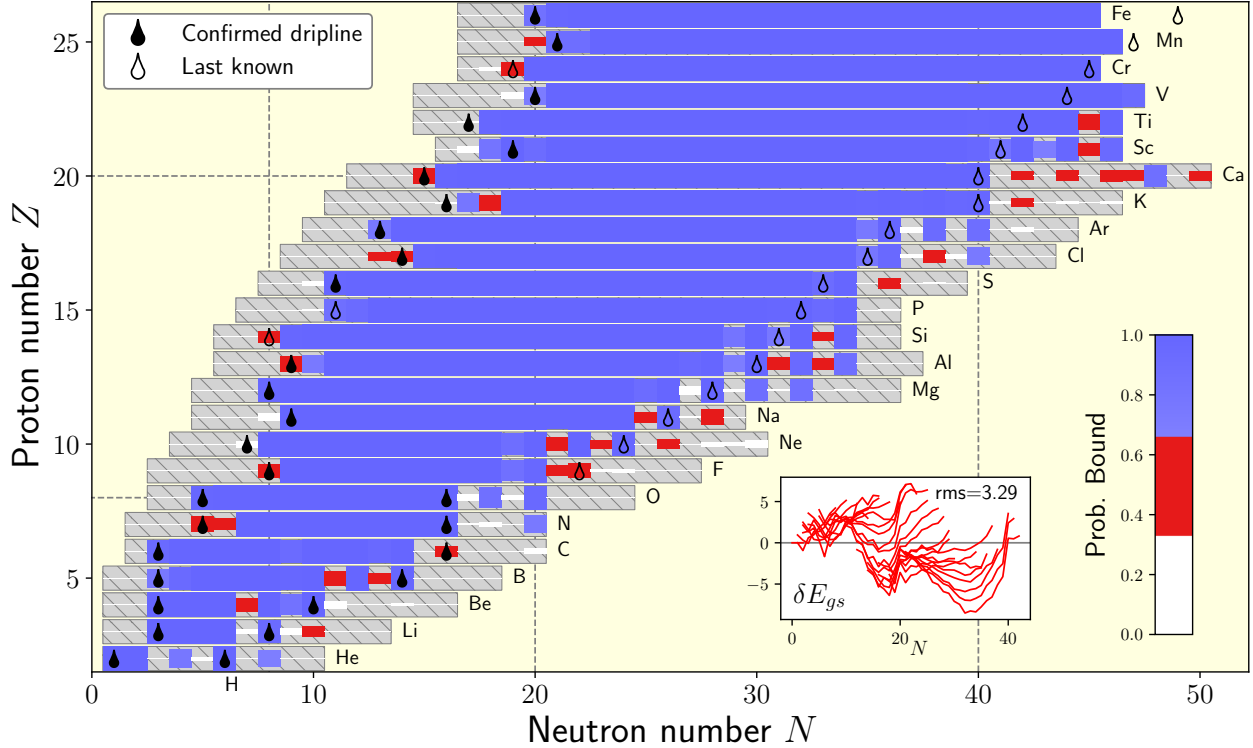

Figure 3.46: Calculated probabilities for given isotopes to be bound with respect to one- or two-neutron/proton removal. The gray region indicates nuclei that have been calculated, while the height of the blue boxes corresponds to the estimated probability that a given nucleus is bound with respect to one- or two-neutron (proton) removal in the neutron-rich (deficient) region of the chart. The inset shows the global agreement with experimental ground-state energies. Figure from Ref. [J.D. Holt, S.R. Stroberg, A. Schwenk and J. Simonis, arXiv:1905.10475 (2019)]

and nuclear theory needed for such experiments including anapole moments, Schiff moments, and EDM, as well as calculating the atomic theory inputs for measurements of isotope shifts, which will give absolute nuclear charge radii and can be connected to other interesting searches for BSM physics.

The most recent progress includes the first global *ab-initio* calculations of all nuclei from helium to nickel, finding an rms deviation from absolute experimental ground-state energies of approximately 3 MeV, a level obtained with phenomenological nuclear mass models. The first *ab-initio* predictions for the proton and neutron driplines in the light and medium-mass region at least through Ni are shown in Fig. 3.46. To investigate the evolution of shell structure, we have also calculated two-neutron separation energy and first excited 2+ systematics for new magic numbers throughout the sd and pf shell region to future efforts at next generation RIB facilities worldwide.

In nuclear-weak physics we have recently included the effects of two-body currents in calculations of Gamow-Teller (GT) transitions. In a joint effort with coupled-cluster collaborators at ORNL, we provided the first systematic *ab-initio* study of g_A quenching up to the Sn isotopes, published in Nature Physics ²⁰⁴.

²⁰⁴P. Gysbers *et al.*, Nat. Phys. 15, 428 (2019).

3.5.2.7 Nuclear Theory and Experiment – Synergy

In addition to the development of the first-principle approaches addressing the key questions of our universe, an important role of subatomic theory is to guide and interpret experiments. In spite of being funding-limited, our theory groups are still recognized as world leaders in many areas, which is in large part due to the close coordination and collaboration with the experiments at home and offshore combined with the SAPES funding model allowing some degree of synergy. While some theory programs require steady progress and years of advance planning to meet experimental timelines, most theorists can provide an immediate and flexible response to new opportunities. We only aim to provide some examples of theory and experiment synergy in this section - there are too many to list. In addition, due to a nimble nature of theory research, theorists are well-positioned to respond to new research opportunities anywhere in the world and often collaborate with experimental groups abroad, greatly contributing to cross-connectivity between different research groups and areas of subatomic physics.

The control over backgrounds is one such area where combining theory and experiment efforts is crucial. For example, two large experiments Mu2e²⁰⁵ and COMET²⁰⁶ are about to search for the very rare muon-electron conversion near a nucleus, $\mu N \rightarrow eN$, extending the search for lepton-flavor non-conservation currently conducted by MEG²⁰⁷. Whereas MEG is looking for $\mu \rightarrow e\gamma$ and aims for a sensitivity of around one exotic process per 10^{14} normal muon decays, Mu2e and COMET will be sensitive to a broader set of New Physics processes at the level of $10^{-16} - 10^{-18}$. It is a challenge to theorists to map the spectrum of produced electrons precisely, taking into account bound states, nuclear effects, and radiative corrections. There will also be an abundance of data, especially in the high-energy tail of the electron spectrum, where the Standard Model background overlaps with the exotic signal region²⁰⁸.

The physics of pions and neutrons is another area where the theory support for the experiment is essential. One example is a new motivation for an improved measurement of the pion beta decay, $\pi^+ \rightarrow \pi^0 e^+ \nu (\gamma)$ ²⁰⁹; another case is the neutron beta decay²¹⁰, and, in both processes, understanding the interplay of radiative effects and hadronic structure is still a major challenge.

Although theory is often more nimble than experiment and can address new challenges more quickly, sometimes a whole new set of theory tools needs to be created to address the needs of the experiment. One such emerging field are multi-loop electroweak radiative corrections evaluated with unprecedented precision and reliability needed for the upcoming ultra-precision experiments like MOLLER and P2. These are challenging, time-intensive research programs spanning multiple years and requiring close coordination with the experiment. For example, the first publication on one-loop electroweak radiative corrections by the theorists in the Canadian MOLLER group was in 2010²¹¹, the group is still just about to complete the large-scale evaluation of two-loop corrections while developing a new methodology for the task²¹². On the other hand, the theory project which was initially inspired by the MOLLER experiment's ambitious precision, has grown into a research field of its own, with many potential applications for planned and yet-to-be imagined measurements.

The *ab-initio* calculations of double beta decay nuclear matrix elements became a focus of a

²⁰⁵R. H. Bernstein, *Front. in Phys.* 7, 1 (2019).

²⁰⁶D. Shoukavy, *EPJ Web Conf.* 212, 01006 (2019).

²⁰⁷S. Mihara, *PoS NuFact2019*, 081 (2020).

²⁰⁸M. J. Aslam, A. Czarnecki, G. Zhang, and A. Morozova, *Phys. Rev. D* 102, 073001 (2020).

²⁰⁹A. Czarnecki, W. J. Marciano, and A. Sirlin, *Phys. Rev. D* 101, 091301 (2020).

²¹⁰A. Czarnecki, W. J. Marciano, and A. Sirlin, *Phys. Rev. D* 100, 073008 (2019).

²¹¹A. Aleksejevs *et al.*, *Phys.Rev.D* 82, 093013 (2010)

²¹²A. Aleksejevs *et al.*, *Phys.Rev.D* 98, 036021 (2018)

broad north-American collaboration with contributions by at least three different groups. TRIUMF theory participates in IM-SRG calculations of ^{48}Ca , ^{76}Ge and ^{136}Xe and in benchmarking of the coupled-cluster and IM-SRG calculations in light nuclei. A research program relevant for the whole neutrinoless double beta decay community including nEXO, an exciting work on *ab-initio* NMEs calculations can push towards the heavier candidates like ^{136}Xe ²¹³, and the study of the quenching factor (Figure 3.10) will impact the sensitivity of the next generation of double beta decay searches.

Several experiments performed at the IRIS facility at TRIUMF ISAC benefited from theoretical interpretation provided by *ab-initio* nuclear structure and reaction calculations, such as the ^{11}C -proton scattering experiment, for example. Nuclear theory also supports planned measurements of the nuclear spin-dependent parity-violating effects in triatomic molecules by evaluating relevant nuclear anapole moments²¹⁴.

At the same time, while well-recognized and in high demand as collaborators internationally, Canadian theorists are sometimes stretched too thin, and, as a result, miss out on exciting research opportunities which would require timely results. Progress in theory is HQP-driven, but the majority of Canadian theorists are not funded at a sufficient level to include Postdoctoral Research Fellows in their groups. Postdocs have a major impact on the research capacity - not only can they work independently on important and timely projects, they also contribute to collaborative discussions and help to train students. An optimized NSERC funding model allowing access to postdocs would help our theory community better support the experimental programs in Canada and off-shore.

3.5.3 Beyond the next five years

Owing to its very nature, theoretical research is less depended on material infrastructure that requires long-term advance planning than its experimental counterpart. However, some of the projects outlined above are both long-term and labor-intensive, and thus require planning for continued or additional personnel such as postdocs, especially if the theory input is required for the timely progress of experimental projects.

Coast to coast, the Canadian researchers are at the forefront of the many developing trends in nuclear and hadronic theory with many examples of close involvement in the major breakthroughs of the field, and is clear that advances in experimental nuclear physics will be accompanied by comparable progress in theory. In addition to the many Canadian experimental endeavours receiving theoretical support, theorists – during the coming years and beyond – will continue their association with major off-shore laboratories such as EIC, GSI/FAIR, RIKEN, NSCL/FRIB, JLab, the LHC, and RHIC. Our community will continue to make significant contributions in all the major areas that define modern nuclear theory, in the time period relevant for this report.

3.5.3.1 Lattice QCD and non-perturbative approaches

Lattice QCD provides a first-principles method to explore the possibility of bound states other than the standard set of hadrons. For instance, recent experiments report results for new states near the charmonium and bottomonium thresholds that may involve tetraquarks or some similar states. Lattice QCD has the potential to study those scenarios and to interpret the underlying

²¹³A. Belley *et al.*, arXiv:2008.06588 (2020)

²¹⁴Y. Hao *et al.*, Phys. Rev. A 102, 052828 (2020)

physics. In this context and in the short- and medium-term, new lattice methods will continue to be refined in the context of conventional bottom-quark hadrons that could prove useful for lattice QCD studies of unconventional bound states. In the finite temperature and baryon density domain, new techniques will be perfected to extend calculations of the QCD equation of state to higher densities, where the QCD action acquires an imaginary value that challenges the probabilistic nature of lattice calculations. Canadians are also actively pursuing efforts to obtain a gravity dual to QCD, thereby enabling the use of string theory techniques to perform analytical, strong-coupled field theory calculations of quantities with experimental relevance.

3.5.3.2 Perturbative QCD

Much of our current knowledge of the substructure of hadrons is based on perturbative QCD, the foundation of which is factorization: the ability to theoretical separate short- and long-distance physics, and to therefore deal with them separately. In the coming years, cross section measurements, paired with precise calculations up to high perturbative order – with the implied sophisticated technology – will continue to be a necessary requirement for obtaining a precise map of the hadronic substructure, including that of the transition region between microscopic and emergent degrees of freedom. Those developments will include the creation of sophisticated numerical tools for the automatic computation of high-order amplitudes.

3.5.3.3 Effective field theory (EFT)

EFTs are a powerful tool in cases where the physics at hand requires a separation of energy scales. This turns out to be the case in QCD, where the long distance phenomena are described in terms of non-perturbative hadrons, and the short-distance physics is formulated in terms of partons. At energies below the proton mass, chiral effective theory incorporates the spontaneous breaking of QCD’s chiral symmetry. It has successfully been applied to mesons for some time, and recent breakthroughs have occurred in its use in few-nucleon systems. Canadian theorists will therefore continue to test this theory by performing studies in light- and medium-mass nuclei, in a continuing fruitful dialogue with their experimentalist colleagues. Concrete future plans for calculations involving the NCSMC (using χ EFT) include the evaluation of (p, γ) , (α, γ) and (n, γ) capture reactions in light nuclei that are relevant for astrophysics. The ultimate goal for the next five years in that field is to study reactions involving ${}^4\text{He}$, e.g. ${}^8\text{Be}(\alpha, \gamma){}^{12}\text{C}$, ${}^{12}\text{C}(\alpha, \gamma){}^{16}\text{O}$, as well as the neutron source reaction ${}^{13}\text{C}(\alpha, n){}^{16}\text{O}$ relevant for the s -process.

3.5.3.4 Phenomenology and model-building

The development of phenomenological approaches guided by empirical data are an essential step that often pave the way to the development of more fundamental theories. They not only serve to guide intuition, but therefore fill the gap that often exists between first-principles approaches and experimental measurements. This category encompasses a large variety of different models and techniques that have been very successfully used by Canadian researchers. Good examples of continuing work are the cross-comparison of results from chiral perturbation theory with lattice cal-

culations, potential model predictions of hadronic mass spectra, and the development of geometries in weakly-coupled gravity that translate to QCD-like field theories under a duality transformation.

3.5.3.5 Nuclear structure and nuclear reactions

Atomic nuclei are intimately connected to some of the most profound questions in science, such as the nature of neutrinos and dark matter, fundamental symmetries, and the inner-workings of neutron stars and the nucleosynthesis pathways. Thus, a comprehensive first-principles, or *ab-initio*, picture of all atoms and nuclei, with robust uncertainty estimates, is required to provide reliable theoretical predictions to help answer such questions. Experimental efforts in these directions are a clear priority for virtually all major international players over the next decade, from the numerous next-generation rare isotope beam facilities, to neutrinoless double-beta decay and dark matter direct detection searches worldwide, and all will require accurate and quantifiable subatomic theory input to both guide and interpret.

3.5.4 Summary

It is essential to maintain a diverse program of research in theoretical nuclear and hadronic physics. A large portion of this theoretical work demands the features associated with HPC facilities; these aspects are discussed in section 4.4 of this document. In addition, much of the progress in theory research is linked to the mentoring of the next generation of theorists. A great opportunity therefore exists to further strengthen and grow this program with strategic investment into highly-qualified personnel who can accelerate the efforts of the recognized Canadian world leaders at the forefront of an exciting and fast-moving discipline that is intimately linked to Canadian experimental efforts in nuclear physics. With a wider regional representation, theorists are also an excellent resource for increasing diversity in the field by attracting women, visible minorities and Indigenous students to this fascinating field, in both theory and experiment.

Chapter 4

Opportunities Enabled by New Facilities

4.1 Canadian facilities

4.1.1 TRIUMF

4.1.1.1 The national and international roles of TRIUMF

As evident throughout this report, TRIUMF, Canada’s particle accelerator centre, is an important resource for many parts of the Canadian nuclear physics program. A large fraction of Canadian nuclear physicists use TRIUMF as their primary experimental facility, and as such rely heavily upon TRIUMF’s capability to develop and deliver both high-quality and high-intensity beams. Because of the favourable and unique characteristics of the rare ion beams in particular, TRIUMF is host to over 500 scientist and student researcher visits per year and has more than 50 international agreements and partnerships. Furthermore, a major collaboration between Canadian and Japanese partners will result in a world-leading ultra-cold neutron source at TRIUMF. The continued development and delivery of high-quality beams is clearly a very high priority item of the [TRIUMF Five-Year Plan](#), and will be of great benefit to the nuclear structure, nuclear astrophysics and fundamental symmetries programs outlined in this report.

Moreover, TRIUMF also plays a major role as a national infrastructure support base to the offshore portion of the Canadian nuclear physics program. 86% of Canada’s subatomic physics research involves TRIUMF in some manner. A noteworthy example is the support for the Qweak experiment at JLab. The total NSERC support for the project was \$3.4 M, with \$0.7 M towards construction of key elements of the hardware, including fabrication of the water-cooled copper conducting coils and holders for the Qweak spectrometer, development and instrumentation of a novel diamond microstrip detector for the Hall C Compton polarimeter, and a small quartz scanning detector used to map the event distribution across the Qweak main detector bars. TRIUMF provided crucial infrastructure support to the Qweak experiment, including oversight of the spectrometer coil fabrication, and design and construction of all of the low-noise analog electronics that were used to read out the Qweak main detectors and auxiliary current mode instrumentation.

TRIUMF support for the ALPHA project at CERN has allowed Canadian physicists to make

leading hardware contributions, in particular in the areas of particle detection systems and cryogenic engineering, e.g. the design and the construction of the ALPHA-2 cryostat and a \$3.5 M radial time projection chamber for the ALPHA-g project.

TRIUMF's continued role as a base of national infrastructure support, in addition to its role as the host of a vibrant in-house nuclear physics program, must be maintained with very high priority.

4.1.1.2 The Isotope Separator and ACcelerator – ISAC

TRIUMF's rare isotope facilities cover an industrial-scale complex combining two core elements: The existing Isotope Separator and ACcelerator (ISAC) facility and the new Advanced Rare IsotopE Laboratory (ARIEL). ISAC is further divided into two experimental halls, housed in adjacent buildings: ISAC-I, for low and medium-energy experiments; and ISAC-II for higher-energy experiments.

The TRIUMF ISAC facility uses the isotope separation on-line (ISOL) technique to produce rare-isotope beams (RIB) by impinging the 520 MeV proton beam from the main cyclotron on different target materials. The ISAC facility has celebrated its 20th anniversary in 2019 and is ready to receive the beams provided by the new ARIEL facility.

The multitude of experiments that are accommodated in the ISAC facilities are listed in Secs. 3.2, 3.3, and 3.4.

4.1.1.3 The Advanced Rare Isotope Laboratory – ARIEL

The Advanced Rare Isotope Facility is TRIUMF's flagship project conceived to ensure Canada's leadership role in rare isotope science. During the period covered by the forthcoming Long Range Plan ARIEL will move from construction to delivering science in a phased approach that brings new capabilities online as early as possible.

Construction of ARIEL is now underway at TRIUMF with the goal to significantly expand TRIUMF's Rare Isotope Beam (RIB) program for Nuclear Physics and Astrophysics, Nuclear Medicine and Materials Science. At its heart ARIEL contains a 350 kW, 35 MeV, 10 mA electron accelerator (eLINAC) for isotope production via photo-production and photo-fission as well as a second proton beam line from TRIUMF's 520 MeV cyclotron for isotope production via proton-induced spallation and fission. The second stage of the project, ARIEL-II, is a joint CFI funding initiative through all 19 TRIUMF member universities (at the time of the application) and led by the University of Victoria. This will allow ARIEL to be completed in the timeframe covered by the forthcoming SAP Long Range Plan. The ARIEL facility holds the promise of world-class, transformative research in five major, interlinked research areas of strategic priority at the participating universities, both for fundamental and applied research (inside and outside the NSERC SAP envelope):

1. Elucidating our fundamental understanding of nuclei. A central goal of nuclear physics is to develop a predictive theoretical framework for all nuclei – a standard model for nuclear physics. ARIEL experiments will provide decisive input to this quest (inside NSERC SAP)
2. Searching for new forces in nature. ARIEL will provide both the beam intensities required for high-precision measurements of the weak interaction, and the multi-user capability to allow experiments to run for hundreds of days per year (inside NSERC SAP).
3. Determining how the heavy elements were produced in the universe. A full understanding of the origin of the elements is within reach. ARIEL will enable decisive measurements of the

nuclear properties of the most exotic neutron-rich nuclei that will help, in conjunction with astronomical observations and astrophysical simulations, to elucidate the so-called r-process, responsible for the production of elements from iron to uranium (inside NSERC SAP).

4. Depth-controlled β -detected Nuclear Magnetic Resonance (β -NMR), pioneered at TRIUMF, provides unique access to magnetic properties at surfaces and buried interfaces in materials, electronics and energy storage devices. ARIEL will bring this technique to full fruition by dramatically increasing the time available for such studies. Probing magnetism at interfaces and surfaces of new materials (outside NSERC SAP).
5. Advancing the molecular imaging of biological systems and the treatment of diseases, including cancer. ARIEL will develop the next generation of medical isotopes for novel imaging applications and targeted alpha therapy of tumours, providing breakthroughs in nuclear medicine ranging from brain health to cancer treatment (outside NSERC SAP).

The ARIEL scientific program will be implemented in phases beginning with advanced beam-cleaning and preparation capabilities for accelerated radioactive beams. These new capabilities will drive forward the programs studying nuclear structure effects in exotic isotopes. This phase will be followed by the implementation of a new production target station to receive first beams from the eLINAC.

Neutron-rich fission fragments produced from more than 10^{13} fissions per second will be possible in the final implementation. Photo-fission will enable the study of the very neutron-rich nuclei involved in the astrophysical r-process responsible for the production of the heavy elements from iron to uranium.

The new proton beam-line (BL4N) will deliver up to $100 \mu\text{A}$ beam onto an additional production target. In conjunction with the eLINAC production target TRIUMF will therefore go from the current single ISAC RIB production target to the parallel production of RIBs on three target stations. This new and worldwide unique multi-user capability will allow for a much better exploitation of the available forefront experimental facilities at ISAC. Aside from the tremendous gain in available time for the material science program also other experimental programs that need large amounts of beam time will be enabled by this multi-user capability of ARIEL. In addition, the capabilities for harvesting isotopes for investigation as potential medical diagnostic and therapeutic isotopes will be implemented through a dedicated and symbiotic target module integrated into the beam dump of the ARIEL proton beam target station. Table 4.1 identifies the key scientific deliverables for each new capability of the facility.

The ARIEL facility is located at TRIUMF and together with the existing ISAC production target and the currently 18 experimental facilities in ISAC-I and ISAC-II a very rich and world-leading user program in all three branches of rare isotope science (nuclear structure and reactions, nuclear astrophysics, fundamental symmetries) will be carried out. The experimental facilities are predominantly operated by collaboration with strong Canadian involvement or under Canadian leadership and thus the ARIEL facility with its dramatic increase in RIB availability and further reach to the extremes of isospin, will elevate the Canadian nuclear physics community even further.

The development and construction of the eLINAC, with Made-In-Canada SRF cavities and in-house development of the electron gun, cryo-modules, beam diagnostics and machine protect systems has been an enormous achievement in accelerator science. This has also benefited the education of several graduate students in accelerator science, who are part of the only graduate program in accelerator science (University of Victoria) in Canada.

Table 4.1: The phased approach of the ARIEL scientific program for the coming decade.

Capability	Will deliver isotopes...	First experiments
CANREB	...to elucidate our fundamental understanding of atomic nuclei by enabling studies of the evolution of structure and dynamics of neutron-rich nuclei.	~2020
Two simultaneous RIBs	...as probes of magnetism at interfaces and surfaces of new functional materials using β -NMR.	~2025
Photo-fission	...to elucidate our fundamental understanding of atomic nuclei by enabling studies of the evolution of structure and dynamics of very neutron-rich nuclei approaching the r-process path.	~2025
Proton target station	...for molecular imaging of diseases and treatment of cancer in the ARIEL collection station and isotopes for developing a standard model for nuclear physics.	~2025
Three simultaneous RIBs	...to search for new forces in nature by searching for violations of Fundamental Symmetries. It will also mark the milestone of three simultaneous rare isotope beams delivered to users.	~2026
Full driver beam intensities	...to determine how the heavy elements from iron to uranium were produced in the universe.	~2029
Routine 9000 RIB hours per year	...to fully exploit the new capabilities of ARIEL for all scientific programs.	~2031

The ARIEL-I phase of the project, constructing the eLINAC, tunnel and the ARIEL building, represented a \$62.9M investment and was completed in 2014. The completion of ARIEL-II requires funding for equipment at a level of \$33.8M for which a CFI application by all 19 TRIUMF member universities, led by the University of Victoria, was submitted in 2014 and was ultimately approved by CFI and all 5 provinces which contributed matching funds. The \$4.2M CANREB project led by St. Mary's university provided key equipment for beam preparation and charge-breeding. An additional \$10M CFI application has been approved for construction of the symbiotic target station with all associated target-transfer and hot-cell infrastructure for harvesting medical isotopes. The manpower to design and construct the ARIEL-II infrastructure is provided by TRIUMF, funded through the operating funds provided by the Canadian government via a contribution agreement by NRC. The operation of the ARIEL facility will be integrated into the TRIUMF operations.

4.1.1.4 Ultra-cold neutron source for fundamental physics

Ultra-cold neutrons (UCN) are free neutrons of such incredibly low energies that they may be stored in material bottles. Hotter neutrons would simply pass through the bottle walls. This property of being able to bottle UCN allows experimenters to study the properties of the neutron with amazing precision, unattainable by any other means. Ultra-cold neutrons are ideally suited to precision experiments testing fundamental symmetries at low energies. The top science priorities in the field are measurements of the neutron electric dipole moment, neutron decay parameters, the neutron lifetime, and gravitational interaction studies.

Experiments using UCN around the globe are limited by the number of neutrons available to the experiment. To advance this field of fundamental neutron physics, a new facility is being built at TRIUMF to deliver more UCN than ever before. It leverages TRIUMF's 500 MeV cyclotron via a unique combination of a spallation neutron source and a superfluid helium UCN converter. This makes the TRIUMF UCN source unique, as competing sources are either based on solid deuterium, and/or use reactor sources for the neutrons. The first planned experiment is a new, precise measurement of the neutron electric dipole moment (EDM), by the TUCAN (TRIUMF Ultra-Cold Advanced Neutron) collaboration. The EDM measurement apparatus features dual measurement cells within a surrounding magnetically shielded room (MSR), see Fig. 4.1.

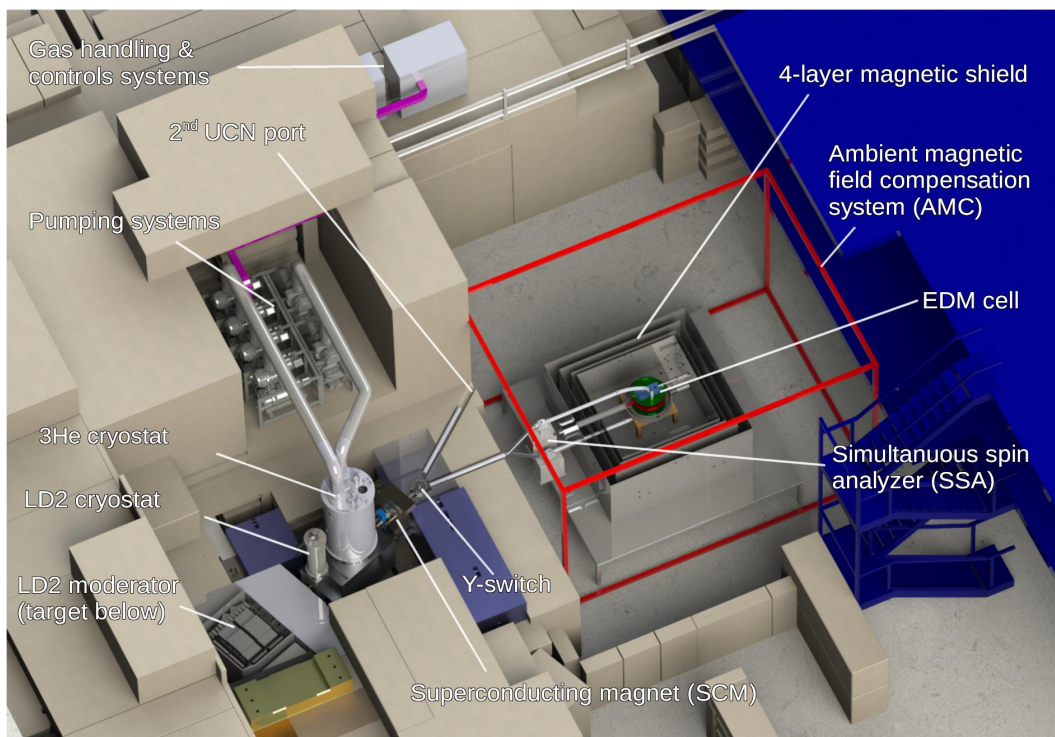

Figure 4.1: Overhead view of the UCN area in the Meson hall at TRIUMF, showing the UCN source components and experimental area for the TUCAN EDM experiment. The radiation shielding has been partially removed to show the UCN source.

An upgrade of the UCN source and EDM experimental apparatus was funded by CFI-IF in 2017, and included partner contributions from Japan and TRIUMF. The main Japan contribution is the He-II cryostat at the heart of the UCN source, which will be tested at KEK in 2020. The medium-term plans (2022-26) involve completing the UCN source upgrade, and constructing and beginning

to run the neutron EDM experiment. During this time, TUCAN expects to reach the limit of the helium liquefier facility in the Meson Hall at TRIUMF, and plans to request a new liquefier based on a turbine system. In the longer term (2027-2036), TUCAN may consider proposing upgrades as required. The UCN source is planned eventually to become a user facility, and is instrumented with a second port to serve another experiment, such as a neutron lifetime or gravitational level experiment.

4.1.1.5 Longer-term upgrades: Storage Ring

A low-energy storage ring coupled to an ISOL facility like ISAC would open new avenues to nuclear physics investigations that were so far hampered by too low beam intensities. The TRIUMF Storage Ring (TRISR) project with a neutron generator will create a world-wide unique facility for the measurement of neutron capture cross sections of short-lived radionuclides (see Sec. 3.3.4.1 for more details.).

The major advantages of the TriSR@ISAC in contrast to the previously proposed TSR@ISOLDE project would be that

- The newly-built CANREB-EBIS is the perfect injector and already provides highly-charged ions.
- Plans for a second acceleration path from the EBIS via a new RFQ (to be installed in the connection between the ARIEL and ISAC building into the medium- and high energy beam-line) are existing and will allow to feed the medium-to-high energy sections of ISAC without compromising the ability to get beam into the low-energy area.
- No new building or extension needs to be constructed since the design will be adapted to fit the TRISR into the existing ISAC-I facility.
- The inclusion of a neutron generator in the storage ring lattice will allow for the first time to directly measure neutron capture cross sections of short-lived nuclei.

The circumference of a storage ring with $E=0.1\text{--}10$ MeV/u is ≈ 50 m (with a $B\rho$ of about 1.5 Tm) and requires roughly footprint of $20\text{ m} \times 20\text{ m}$. The injection energy and A/q are given by the ISAC-I medium-energy acceleration chain (150 keV/u up to 1.8 MeV/u, A/q up to 6). Further acceleration inside the ring can bring the circulating ions up to about 10 MeV/u. The installation of an external ion source would allow to run tests independent of the ISAC acceleration chain and shutdown phases.

A potential space for the TRISR would be the north/east corner of the ISAC-I experimental hall (see Fig. 4.2) which is presently occupied by two beamlines which could be easily re-arranged. The remaining area is temporarily used as working space for the target module handling. With a re-arrangement of the TUDA beamline and after completion of the ARIEL project this experimental area would be ideally suited for the TRISR@ISAC project without the need to construct a new annex hall.

The upcoming years will be used to seek funding for a machine study via a 3-year NSERC Project Grant (to be submitted in 2021) and potentially a NFRF (New Frontiers in Research Fund). The rough timeline for the project after the approval of the new NSERC Project Grant would be:

- 2022: Start with beam dynamic calculations

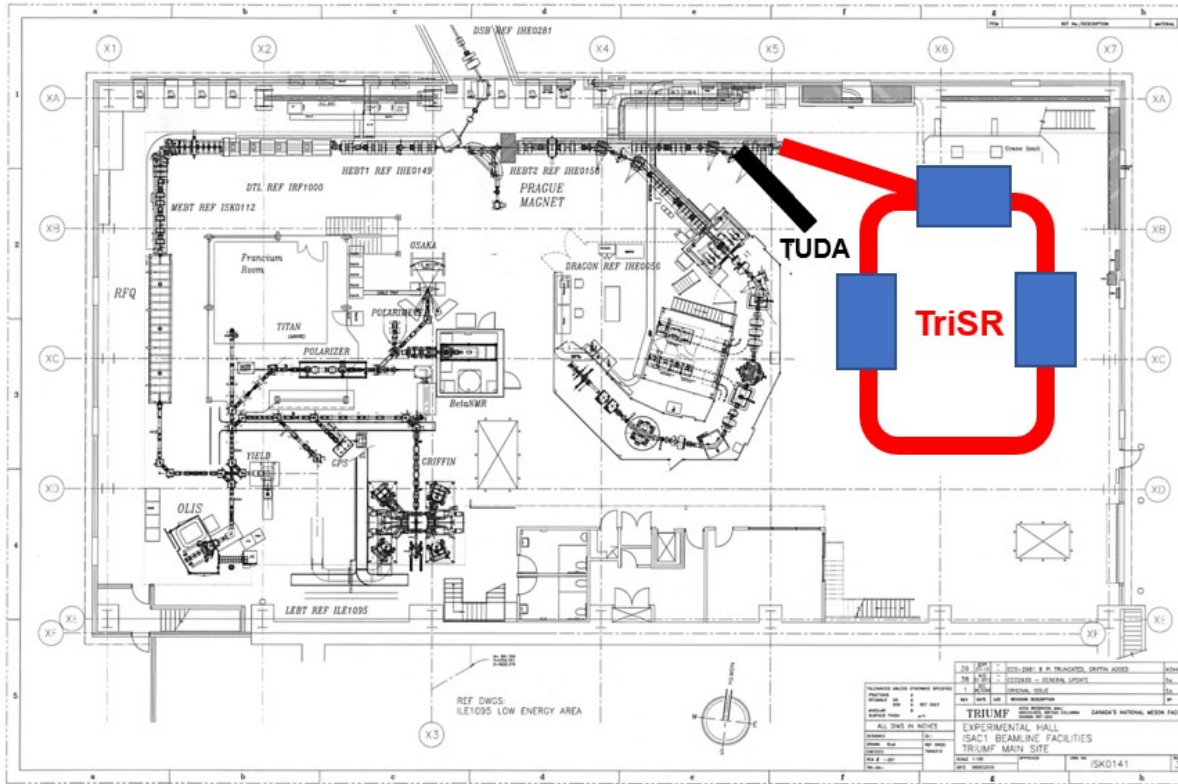

Figure 4.2: Proposed location of the neutron generator and the TRISR in the ISAC-I hall at TRIUMF. The blue boxes indicate possible locations for the electron cooling, the neutron generator, and the gas target.

- 2022/23: Definition of a Physics program (White Paper); Design of cavities, electron cooler, gas target, neutron generator, RF cavity design, magnet design, power supplies specifications, vacuum system layout, electron cooler specs, beam diagnostics design
- 2023/24: Physics book
- 2024/25: Technical design report (TDR) finished including budget; CFI Project Preselection phase at partner university; Submission of Letter of Intent
- 2025: Submission of CFI grant for storage ring and neutron generator (project size \approx C\$30-40 million)
- 2026: If CFI funding successful: Start of construction

After the start of the constructions in 2026, the first commissioning of the storage ring with beam can be expected within 3 years (in 2029/30). Taking at least 1 year for full commissioning, the facility could be fully operational for first physics (Day-0) experiments in 2031. With an external ion source, the neutron generator could be installed and tested with part of the beamlines earlier, potentially already in 2028.

For the operating costs after finalization of the construction, CFI-IOF funds would be sought. For a project size of C\$35 million this would mean a request of C\$10.5 million over 5 years from

2030-34.

The additional staff from TRIUMF Accelerator Division required for the long-term operation of the new facility as well as other operational requirements would require a increase of the NRC contributions to TRIUMF from 2026 on (in the next TRIUMF 5-Year-Plan, 2025-30 and following), as well as give the opportunity for an additional new faculty position to strengthen the connection between TRIUMF and its partner universities.

4.1.2 SNOLAB

SNOLAB is the Canadian underground science laboratory specializing in neutrino and dark matter physics. Located 2 km (1.24 miles) below the surface in the Vale Creighton Mine near Sudbury in Ontario, SNOLAB is an expansion of the existing facilities constructed for the Sudbury Neutrino Observatory (SNO) solar neutrino experiment.

SNOLAB has been developed as one of the world's premier underground laboratories through the considerable assistance of CFI, the Governments of Ontario and Canada, and university partners. Besides operating one of the deepest clean underground facilities, SNOLAB developed extensive expertise in the design, construction, and operation of ultra-low background experiments. This unique expertise makes SNOLAB the lab of choice for future experiments. As discussed in Sec. 3.4, experiments proposed for or under development at SNOLAB may be able to address some of the most important questions regarding the nature of the neutrino. The decision by the USA to consider siting a tonne-scale neutrino-less double-beta decay experiment at SNOLAB is very exciting, regardless of which experiment is chosen. Particularly if nEXO is selected in the DOE decision-making process, it will allow Canadians to leverage considerable international resources while participating in a world-class experiment onshore. The consultations for SNOLAB's institutional long range plan are just getting underway, and this is an excellent opportunity to ensure that the subatomic physics community's long term aspirations and SNOLAB's are in alignment.

4.2 International facilities

4.2.1 Thomas Jefferson National Accelerator Facility

Jefferson Lab (JLab) is the world’s largest nuclear physics user facility, numbering nearly 1700 users, which is an increase of nearly 50% since 2013. Canadians are the third largest international group at JLab, behind France and Italy. The JLab 12-GeV Upgrade, enabling a doubling of the available electron beam energy and the construction of a suite of new detectors, was completed in 2017, opening up many new physics opportunities that have been rated very high merit by a wide variety of scientific reviews. Canadians have leading roles in several high profile experiments that are either currently acquiring data, or scheduled to acquire data in the near future, including the GlueX experiment in Hall D, and the pion form factor experiment in Hall C.

Over the course of this long range plan, Canadian efforts at JLab will revolve around several new initiatives, in which they take leading roles:

1. JEF - JLab Eta Factory involves a significant upgrade of the GlueX base instrumentation by replacing the inner section of the GlueX forward calorimeter (FCAL) with a higher-granularity detector (FCAL-II), and is planned to come online in 2024. See Sec. 3.1.2.2.
2. The MOLLER experiment aims to make the world’s most precise off-resonance measurement of the *weak mixing angle*, using polarized electron-electron scattering. The “early finish” for the construction project is July 2025, but the DOE schedule provides float until 2027. This will be followed by roughly 3 years of data taking and probably two additional years of analysis effort. The Canadian group is responsible for the development of the integrating detector array, for which a proposal was submitted to the 2020 CFI competition, as well as other important aspects of the project. See Sec. 3.4.2.2.
3. The Solenoidal Large Intensity Detector (SoLID) will use the latest detector and readout technology to enable an increase in luminosity by a factor of 10 compared to existing detectors. SoLID is in an advanced stage of project planning, with Canadians contributing to Cherenkov detector R&D and construction. SoLID will see continuing scientific activity through 2036. See Sec. 3.1.2.2.

In order to capitalize on this leadership and the noteworthy scientific opportunities, these Canadian efforts should be supported with high priority.

4.2.2 CERN (Antiproton Decelerator and ELENA)

The Antiproton Decelerator (AD) at CERN is the world’s only facility which provides low energy antiproton beams. The ALPHA–Canada collaboration at the [Antiproton Decelerator at CERN](#) draws upon Canadian expertise in atom, laser, microwave and trap techniques that are common to other CINF projects, such as the TITAN, CPT, TRINAT, FrPNC, and UCN experiments. ALPHA–Canada is the single largest group in ALPHA, consisting of about 1/3 of the international collaboration. The Canadian contributions to the ALPHA program are very significant, and they have leading scientific and technical impact within the collaboration.

Construction of a second generation apparatus – ALPHA-2 – was enabled by significant Canadian contributions. It provides optical access to trapped antihydrogen for laser spectroscopy, which was not previously possible. During the current LPR period—using ALPHA-2—we have realized

dramatic increases in trapping rates and exciting physics results, including 10^{-12} level laser spectroscopy, 10^{-5} level microwave spectroscopy, and a first-ever demonstration of H laser cooling. ALPHA-3 upgrades ALPHA-2 with state-of-the-art laser and frequency metrology. In parallel, a new apparatus, ALPHA-g, has been constructed to directly measure the effect of gravitational force on antimatter—for the first time. ALPHA-Canada is a leading player in this project, with more than 80% of the construction funds coming from Canadian sources.

ELENA — Extra Low ENergy Antiproton — is a major upgrade to the AD, and will further slow antiprotons from the AD (5.3 MeV) to the 100 keV regime, while serving the beams simultaneously to up to four experiments. After several years of development, ELENA is expected to deliver its first beams for ALPHA in 2021. The advent of ELENA will ensure antiproton physics opportunities at CERN for the next 10+ years. HAICU is a proposed R&D initiative by ALPHA-Canada, and its initial goal is to develop quantum sensing techniques in Canada, using atomic hydrogen and other cold atoms as a proxy for antihydrogen. Such techniques, once demonstrated, will be developed at CERN for experimentation with antihydrogen atoms at unprecedented precisions.

The combined capabilities of the ALPHA-3 and ALPHA-g infrastructures at CERN, and the R&D platform HAICU at home in Canada, will offer tremendous opportunities for fundamental science and advanced HQP training. These initiatives will enable Canadian scientists and their HQP trainees to capitalize on very significant investments, from Canadian and international sources, in ALPHA’s research infrastructure. They will directly result in precision tests of fundamental symmetries, and of some of the most basic assumptions in physics.

4.2.3 Canadian involvement in the Electron-Ion Collider (EIC)

The [Electron-Ion Collider \(EIC\)](#) is a major new collider facility to be built at Brookhaven National Laboratory on Long Island, New York, by the US Department of Energy in the current decade. At the EIC, polarized electrons will collide with polarized protons, polarized light ions, and heavy nuclei at luminosities far beyond what is currently available. The facility will answer several fundamental questions central to completing an understanding of atoms and integral to the agenda of nuclear physics today.

The EIC project achieved two milestones in 2019-2020, with the first critical decision (CD-0) establishing mission need, and with the site selection of Brookhaven National Lab. The project aims to complete the next three critical decisions by the end of 2023, and to start operations by 2030. The EIC Users Group is coordinating the international efforts to instrument the two interaction regions of the collider, with Expressions of Interest invited by November 2020.

Canadian subatomic physicists have participated intensively in the planning of this new facility and have chartered a multi-institutional EIC-Canada Collaboration to coordinate participation. Expanding on programs in experimental and theoretical nuclear physics, hadronic physics, heavy ion physics, and electroweak physics, Canadian participation in the Electron-Ion Collider will focus on detector design and physics program development (2022–2026), detector construction (2026–2030), and operations (2030 and beyond).

The Electron-Ion Collider (EIC) will consist of a polarized electron ring with a variable beam energy from 10 to 20 GeV, and an ion ring with a variable beam energy from 50 to 250 GeV, allowing for beams of polarized protons, deuterons and ^3He , as well as unpolarized nuclei up to lead and uranium. This range of energies will allow for center of mass energies \sqrt{s} from 20 to 100 GeV (upgradeable to 140 GeV) with a collision luminosity \mathcal{L} of $10^{33-34} \text{ cm}^{-2} \text{ s}^{-1}$ (optimal luminosity of $10^{34} \text{ cm}^{-2} \text{ s}^{-1}$ at $\sqrt{s} \approx 105 \text{ GeV}$, about 1000 times larger than at HERA, the only previous electron–

proton collider). Despite the high luminosity, the interaction rate and multiplicity/occupancy rate are manageable compared to the proton–proton collisions at the Large Hadron Collider (LHC). Event rates up to 10^5 Hz per unit solid angle are expected.

The EIC will be built at the Brookhaven National Laboratory in Upton, New York, where the Relativistic Heavy Ion Collider (RHIC) has collided two beams of polarized protons or of unpolarized heavy ions with each other for the past two decades in the STAR and PHENIX experiments. The EIC project will require the addition of a new rapid-cycling polarized electron synchrotron, and the upgrade of one of the existing hadron ring with electron cooling and new spin transport elements (see Figure 4.3).

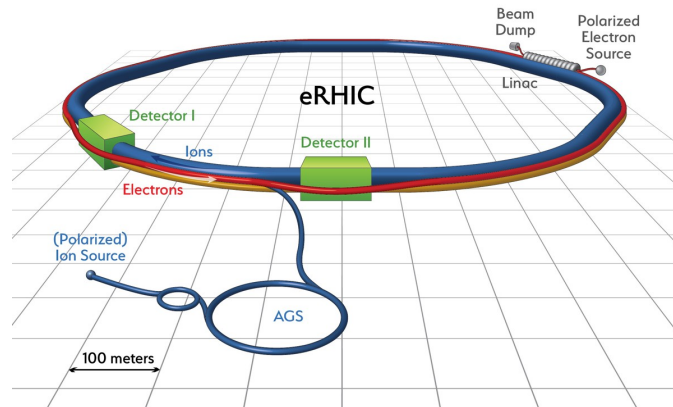

Figure 4.3: The Electron Ion Collider adds a polarized electron beam to the existing Relativistic Heavy Ion Collider (RHIC) accelerator complex with its two hadron rings, substantially avoiding the need for civil construction. Two interaction regions will allow for dedicated collider detectors.

The high luminosity means that the electron beam must be injected from the polarized source with its final polarization of 85% and in flexible spin patterns, building on the operational experience of the Jefferson Lab program. The RHIC facility has operated successfully with polarized proton beams of 80%, and has demonstrated a polarized ^3He source at 85%.

Two interaction regions will each allow for a collider detector. Due to the asymmetric nature of the collision (in contrast to, *e.g.* Belle-II or the LHC), the detectors are highly asymmetric. Three classes of events are of interest and determine the detector requirements.

- *Inclusive measurements* ($ep/eA \rightarrow e'X$), in which either the scattered electron or the full scattered hadronic debris is detected with high precision, require good electron identification and excellent electron energy/momentum and angular resolution.
- *Semi-inclusive measurements*, in which the scattered electron is detected in coincidence with at least one hadron, require hadron identification (π^\pm , K^\pm , p^\pm) over a wide kinematic range, and good vertex resolution for charm and bottom separation.
- *Exclusive measurements*, in which all scattered particles are detected, require high rapidity coverage, including a zero degree calorimeter for neutrons/photons.

Based on these requirements, detectors will be developed by several international consortia. The first phase of this process is currently underway through a Yellow Report process, and Expressions

of Interest (EoIs) by countries or geographical regions interested in potential EIC equipment cooperation are due by November 2020. An EoI from the EIC-Canada Collaboration will be among them.

The EIC-Canada Collaboration anticipates that the next 5 years will be a period of growth. Opportunities exist for subatomic physics groups with detector technology expertise to join the EIC-Canada Collaboration. The current members are in leadership positions in the detector development and physics working groups, as well as the software working groups. The start of the first North American collider of this century will be associated with significant scientific interest. In the first years of the 2030s, significant new results will be published by the two detector collider collaborations. It is anticipated that the Canadian participation in the first new North American collider in this century will become similar in scope as, *e.g.*, the Canadian participation in the Belle-II experiment.

There is significant synergy in the physics programs of the Electron-Ion Collider and the Jefferson Lab 12 GeV facility. As the Electron Ion Collider program is ramping up, the Jefferson Lab 12 GeV program continues to take advantage of the energy upgrade completed in 2017. As of summer 2020, there are another 11 years of physics experiments approved for running at Jefferson Lab, with additional experiment proposals evaluated annually. The Jefferson Lab leadership is currently engaging in a 1-year idea gathering effort to define how their mission will be reshaped or expanded in the 2030s. However, this is unlikely to include a hardware project of similar scope as the Jefferson Lab 12 GeV upgrade or the Electron-Ion Collider construction. With the completion of the upgraded detector construction and commissioning (including the GlueX experiment that is in its third year of data taking), this bandwidth has become available to Electron-Ion Collider detector design and construction efforts. While EIC-Canada anticipates an increasing focus on the Electron Ion Collider program, this will not come at a cost to the Jefferson Lab 12 GeV program. Canadian participants remain committed to the success of the Jefferson Lab parity program, a unique program world-wide.

4.2.4 Leveraging opportunities at other facilities world-wide

The Canadian contributions at the facilities listed below (in alphabetical order) are smaller but they nonetheless have significant impact within their respective collaborations. Each are worthy of funding on their own merits. In some cases, the investigators have indicated that their efforts are expected to wind down over the next years, whereas the efforts at new major radioactive beam facilities that are presently under construction, like FRIB and FAIR, will increase over the next decade.

4.2.4.1 Argonne National Laboratory (ATLAS), USA

Canadian physicists use beams from the in-flight reactions or the CARIBU (Californium Rare Isotope Breeder Upgrade) fission fragment source at the [ATLAS facility](#) for nuclear structure and astrophysics studies. The Canadian Penning Trap (CPT) mass spectrometer (see Sec. 3.3.3.2), originally constructed for use at the TASC facility of the AECL Chalk River Laboratories, has been operational at Argonne National Laboratory since 2001. Its mass measurement program is complementary to that carried out with the TITAN facility at ISAC (Sec. 3.2.3.1). However, the future involvement of Canadian groups in the CPT program reaches an a natural end due to faculty retirements.

A temporary setup at Argonne is the [SuN \(Summing NaI\(Tl\)\)](#) total absorption spectrometer from Michigan State University. In collaboration with the University of Guelph neutron capture cross sections will be constrained via the “ β -Oslo method” (see Sec. [3.3.3.2](#)).

4.2.4.2 Duke University Free-Electron Laser Laboratory (DFELL), USA and Mainz Microtron (MAMI), Germany

At the Duke University Free-Electron Laser Laboratory in North Carolina has been a considerable investment of Canadian infrastructure from the former Saskatchewan Accelerator Laboratory to the High Intensity Gamma Source (HI γ S).

The MAMI accelerator complex in Mainz is planned to wind down operations over the next 5–7 years. Canadian plans are to transition efforts to JLab, the Duke facility, and the new EIC.

4.2.4.3 Facility for Antiproton and Ion Research (FAIR), Germany

[FAIR](#) at the GSI Helmholtz Center for Heavy Ion Research in Darmstadt/Germany is the largest of the next generation of radioactive beam facilities that are presently under construction. First beams are expected within the next 5 years. As for the other two in-flight fragmentation facilities, RIBF and FRIB (Sec. [4.2.4.8](#) and [4.2.4.4](#)), the research program is largely complementary to the nuclear structure and astrophysics program carried out at TRIUMF-ISAC.

Canadian scientists are involved in various independent research programs under the NUSTAR umbrella. Examples are reactions with relativistic beams in the SUPER-FRS collaboration (see Sec. [3.2.3.2](#)) and β -delayed neutron experiments within the DESPEC collaboration (see e.g. Sec. [3.3.3.2](#)). In addition, Canadian scientists are heavily involved in the design and construction of detectors for the ILIMA research program at the existing Experimental Storage Ring (ESR) and the future Collector Ring (CR) (see Sec. [3.3.3.2](#)). This collaboration is crucial as seed for the future plans of a heavy-ion storage ring coupled to the TRIUMF-ISAC facility (see Secs. [3.3.4](#) and [4.1.1.5](#)).

4.2.4.4 Facility for Rare Ion Beams (FRIB), USA

[FRIB](#) at Michigan State University/USA is one of the next generation of radioactive beam facilities that are presently under construction. First beams for commissioning of setups are expected by late 2021/ early 2022. As for the other two in-flight fragmentation facilities, RIBF and FAIR (Sec. [4.2.4.8](#) and [4.2.4.3](#)), the research program is complementary to the nuclear structure and astrophysics program carried out at TRIUMF-ISAC. Canadian nuclear physicists were involved in experiments at the former NSCL and will continue to contribute to the exciting science program that FRIB will enable.

4.2.4.5 Grand Accelérateur National d’Ions Lourds (GANIL)

[GANIL](#) is France’s national heavy-ion facility and is one of the premiere research centers that specializes in the production of a wide variety of intense stable and rare-isotope beams for nuclear physics research and applied nuclear science. The facility can produce fast rare isotope beams by in-flight projectile fragmentation at the LISE facility or with the Isotope Separation Online (ISOL) at the SPIRAL facility.

In 2020, the facility commissioned the SPIRAL2 superconducting linear accelerator that will be used to accelerate light ion beams (protons, deuterons, and helium) to 40 MeV with very high intensities of up to 5 mA. Canadian physicists collaborate with GANIL staff on nuclear instrumentation and detector development projects as well as conduct research at the GANIL facility on the structure of nuclear matter (Sec. 3.2), nuclear astrophysics (Sec. 3.3), and low-energy precision tests of fundamental symmetries (Sec. 3.4).

4.2.4.6 Mainz Energy-Recovering Superconducting Accelerator (MESA), Mainz, Germany

MESA is a high current electron accelerator that is under construction in Mainz, Germany. The Canadian MOLLER group is pursuing a synergistic opportunity to contribute to the P2 parity violation experiment there, as it will use the same detector electronics being developed by this group for the MOLLER experiment at JLab. Beam operation is foreseen to start in 2023.

4.2.4.7 Oak Ridge National Laboratory (SNS) and National Institute of Standards and Technology (NIST), USA

As discussed in Sec. 3.4.2.4, Canadians have been involved in fundamental neutron studies using the Spallation Neutron Source (SNS) at Oak Ridge. The Nab experiment will begin collecting data in 2021 and continue until 2024. After which spin polarized cold neutrons will be used with the same apparatus to measure the neutron beta decay correlation coefficients “big A” and “big B”.

The BL3 experiment, at the NIST Center for Neutron Research, in Gaithersburg, Maryland, will achieve an improvement on the precision of the neutron lifetime using the “beam” method that will resolve the long-standing discrepancy between the “beam” and “bottle” methods. The project infrastructure proposal is currently under review by the US National Science Foundation under the Mid-Scale Infrastructure program (\$3M). The experiment intends to run by 2025.

In the long term (beyond 2029), Canadian work at both facilities are expected to gradually ramp down, as efforts are diverted to the MOLLER experiment at JLab and the EIC.

4.2.4.8 RIKEN Nishina Center (RNC), Japan

The RIKEN Nishina Center in Wako/ Japan operates the Radioactive Ion Beam Factory (RIBF), which can produce the presently most intense exotic radioactive beams by in-flight fragmentation. The research program carried out at RIBF is complementary to the nuclear structure and astrophysics program carried out at TRIUMF-ISAC. The experimental program of Canadian scientists comprises reactions with relativistic beams (see Sec. 3.2.3.2), as well as the measurement of β -delayed neutron emitters with the RIKEN setup which will conclude in 2021 (see Sec. 3.3.3.2).

4.2.4.9 Texas A&M University Cyclotron Institute

The Cyclotron Institute at Texas A&M University delivers heavy-ion beams in a wide range of energies using its K150 and K500 cyclotrons. In-flight rare-isotope beams created with the MARS separator are also available. Canadian scientists making use of this facility focus on indirect measurements of astrophysical capture reactions, e.g. through measurements of transfer cross sections

or decay branching ratios. A particular emphasis placed on experiments that directly complement work being done at TRIUMF.

4.3 Accelerator development for nuclear physics

The TRIUMF Accelerator Division has plans for projects in several areas of interest to nuclear physicists. Short and intermediate-term projects are primarily in support of enhanced beam properties for ISAC/ARIEL, but longer-term projects include research into new accelerator concepts, such as those discussed in Secs. 4.1.1.5 and 4.2.3. Those projects are directed to beam or accelerator development for a specific goal which would more likely be supported by TRIUMF or CFI funds, while the most fundamental accelerator physics questions might fall within the purview of NSERC SAPES funding.

4.3.1 ISAC/ARIEL High-power target development

To fully exploit the future increase of beam power provided by the driver accelerators, new high-power target technologies are required. Target development addresses material development and new target station technologies including remote handling. Commissioning of ARIEL target stations and ramping the driver beam power to unprecedented levels is an important objective of this LRP period and will require development projects. The electron-to-gamma converter target concept that involves a two-stage process where electrons bombard a sophisticated material composite converter positioned in front of the target container to create bremsstrahlung photons need to demonstrate 100 kW capabilities. In the long term, a concept will be required to go beyond this power stage, which is a huge challenge.

The TRIUMF targets and Ion Sources Department is embedded in a framework of international collaborations. TRIUMF is leading in the application of high-power targets for radioisotope beam production and handling of target components. New technologies are developed for and with international partners. TRIUMF has an existing strength in the engineering of efficient high-power target material structures. Building on this leading position and within the RADIATE collaboration, TRIUMF is developing the infrastructure and methodology to test materials in extreme GGy/h-level radiation fields and analyze microscopic and mechanical degradation.

RIB ion source and transfer line development capability will be required to provide new, purer, and more intense isotope beams to the NP community. The ARIEL target assembly concept will allow for more versatile and capable ion sources and selective transfer lines. An ARIEL laser ion source will initially be installed in the east station only and will be the element selective workhorse for RIB delivery. In the long term, laser-ionized radioisotopes need to be available from both ARIEL target stations, requiring additional investments.

The development of new targets requires detailed understanding of materials and chemistry at high temperatures. The R&D on new target compositions and materials requires according laboratory infrastructure at TRIUMF, which goes beyond the present stage. Conventional chemistry lab, specialized target assembly and test areas as well as an Actinide target laboratory are mandatory for the long-term future of target R&D for secondary particle production.

4.3.2 ISAC accelerator development

Another focus in terms of beam delivery of rare isotopes to experiments is on the beam preparation and the post acceleration capabilities. In the period of the LRP, TRIUMF accelerator division will exploit the full potential of CANREB and the ISAC beam preparation addressing charge state breeders, beam cooler, yield stations and mass separators. In the long term a multi reflection time-of-flight (MR-TOF) analyser will complement the high-resolution separator and the yield stations.

On the ISAC post accelerator side, long term developments even beyond the period of the LRP, are envisaged to boost the final energy of ISAC-II and to add a low energy storage ring for nuclear astrophysics investigations. To boost the ISAC-II energy a stripping foil would be employed at beam energies beyond 6 MeV/u to increase the charge state before a new high performance (high gradient) cryomodule give a boost to >20 MeV/u for $A/q = 2$ ions.

A low-energy heavy ion storage ring connected to an ISOL facility (see Secs. 3.3.4.1 and 4.1.1.5) provides a unique environment to carry out nuclear physics experiments with stored radioactive beams due to the up to six orders of magnitude increased luminosity compared to “one-time-pass” experiments. The installation of a low-energy storage ring at ISAC-I would create a worldwide unique facility and provide a valuable extension of TRIUMF’s physics program by attracting new users. The design of a storage ring and neutron source to generate a neutron target which will allow neutron transfer measurements, is a challenging task, which will provide unique training of young researchers in a new field of Accelerator Science for Canada.

A neutron generator based on (d, d) or (d, t) reactions, the moderation technology and required shielding will lead neutron science and in health physics into a new territory. A suitable storage ring should cover an energy range of about 0.1-10 MeV/u, has approx. 50 m circumference providing a maximum beam rigidity of about 1.5 Tm. A design study will aim for a TDR within the period of the LRP so construction could potentially start thereafter.

4.3.3 Electron-Ion Collider related accelerator technologies

The Electron-Ion Collider (EIC) at Brookhaven National Lab is the first major collider to be built in North America in the 21st century, and a challenging accelerator project with the most demanding operational parameters in terms of intensity and luminosity for the electron and ion beams. The EIC will require high polarization, sophisticated SRF cavities, hadron beam cooling with intense electron beams that require Energy Recovery Linac (ERL) technologies. The beam dynamics design for the different machines is challenging in particular the spin dynamics and keeping a high degree of polarization of the beams.

TRIUMF’s accelerator physicists and engineers could support the construction as a Canadian in-kind contribution. Contributions could be systems like crab cavity cryomodules, high brightness electron gun, beam physics models as well as ERL studies for hadron cooling. The beam physics of the EIC collider accelerators requires handling of high degrees of polarization (up to 85%). The spin dynamics has to be treated within a highly symmetric ring lattice and residual depolarization effects will need correction with partial Siberian snakes. The TRIUMF beam physics group wants to embark on spin dynamics in rings via an involvement in SUPER KEKB led UVic. The treatment of spin dynamics in SUPER KEKB and according spin-optics devices will prepare the group for an engagement at the EIC. The goal is to give Canadian scientists a place at the table while engaging senior and junior accelerator scientist in a cutting-edge accelerator project.

4.3.4 General Accelerator R&D

4.3.4.1 Model-based and model-coupled beam tuning

New accelerator facilities or upgrades of existing accelerators aim for unprecedented beam properties that do not allow for beam losses and may require smart machine control and protection systems. For beam production and delivery, sophisticated numerical codes are used to determine operation parameters, and to predict beam parameters at locations of beam diagnostics elements. This

model coupled beam tuning also provides opportunities to introduce model-based beam tuning and Machine Learning (ML) for particle accelerators.

TRIUMF Accelerator R&D is working on full end-to-end accelerator beam simulation models of accelerators, like the linacs of the ISAC facility. Usually, multiparticle tracking codes are employed, ray tracing thousands to millions of particles through the system, depending on the desired accuracy of the calculation. While these provide the advantage of illustrating individual particle evolution throughout the accelerator, they are generally computationally intensive and slow. The TRIUMF developed envelope code TRANSOPTR, a second order beam transport code that is based on the Hamiltonian formalism of relativistic charged particle beams, is capable of a fast output in real time comparable to beam measurement periods. This allows the implementation of the code TRANSOPTR as part of an accelerator tuning tool at TRIUMF as a first step towards model coupled accelerator beam tuning and machine learning. High level applications (HLA) will play a major role in this R&D, on one hand using HLAs such as beam phase space tomography, while on the other hand allowing the development of new application that will allow tests of a model coupled beam tuning procedures.

The objective of this R&D is the training of a tailored NN with a benchmarked TRANSOPTR model to prepare a first test by using a virtual accelerator testbed platform allowing for off-line testing and analysis of tuning algorithms on the ISAC accelerators. This testbed is under development in the framework of a Ph.D. thesis. The final long-term goal is the automatic beam tuning of the TRIUMF ISAC linacs and the compensation of drifts of RF-phases of cavities that deteriorate the transmission of beam towards the many experiments served. The transfer of the beam tuning technology to driver beam accelerators like the TRIUMF e-linac will be possible.

4.3.4.2 High intensity proton driver accelerators (medical purpose or neutron production)

TRIUMF's expertise in high power accelerators has been requested by the community to support the development of a Canadian Compact Accelerator-driven Neutron Source (CANS) and a high gradient high intensity driver accelerator for tumor therapy. CANS technology is modular, highly tuneable, and dramatically less expensive than other methods of neutron production. The R&D for CANS and medical accelerators comprises high current ion sources, high intensity Radio Frequency Quadrupole (RFQ) accelerators and modern high gradient H-type structures and RF- systems. For the neutron production, high power target-moderator systems are a new field of R&D TRIUMF's Accelerator division will address in the period of the LRP.

4.4 The role of high performance computing

Funded via CFI, Compute Canada has provided shared national computing infrastructure to the nuclear physics research community. This delivery model is now changing, with a New Digital Research Infrastructure Organization (NDRIO) being set up by Universities Canada, and the continuation of CANARIE with a revised focus on research networks and cybersecurity. It is vital that the new organization be responsive to the needs of research fields making substantial use of high performance computing, such as subatomic physics. This section summarizes the importance of shared high performance computing resources to the experimental and theoretical nuclear physics research communities. Next-generation projects will require even more resources, so they must be carefully planned and effectively operated.

4.4.1 Experimental nuclear physics requirements

4.4.1.1 Jefferson Lab

The experiment with the most significant computing demands is GlueX at JLab. The GlueX computing model is to do the lion's share of the raw data reconstruction at the National Energy Research Scientific Computing Center (NERSC) in the USA. In 2018, GlueX received 23 Mhr allocation at NERSC. For 2019 and beyond GlueX requested 45 Mhr from NSERC and received 14 Mhr. Incoming data monitoring (first 5 files of each run), iterative calibrations and data skims being done on the Jefferson Lab cluster. The anticipated computing resources from Jefferson Lab for GlueX per year are estimated at 35 Mhr. The remainder of GlueX annual needs are anticipated at 35-50 Mhr via OSG, including Canadian resources. The latter estimate comes from the GlueX 2018 summer simulation campaign, which used a substantial amount of time on Compute Canada together with another half dozen US university clusters. The numbers are based on GlueX Phase II (high-intensity running that began in fall 2019). Monte Carlo simulations and data analysis will be performed off-Jefferson Lab, with approximately 30% of the simulations to be performed on Canadian facilities for the next 5 years. The GlueX MC requirement was reduced significantly recently due to changing the anticipated number of simulated events from 2 per L1 triggered event to 2 per useful reconstructed physics event (roughly a factor of 4 reduction). For the Canadian fraction of the simulations and raw data reconstruction, an average demand of 1500 Intel cores ((e.g. Intel E5-2683 v4 "Broadwell" at 2.1GHz, like on the Cedar cluster base nodes) is projected for 5 years starting in 2019, with 600 TB of grid-accessible storage starting in 2019. For a logistically efficient operation of GlueX simulations and data analyses across many clusters and including Compute Canada, it is essential that the workflow is managed through the OSG job environment and Compute Canada technical support was requested to that end. A smooth workflow was accomplished during the 2018 summer campaign by using a single Jefferson Lab node as the launch point through OSG to all clusters that were part of that effort.

The MOLLER experiment, whose data taking is projected to be from 2025-30, plus an additional 4 years of data analysis afterward, project an increase in storage needs from 200 TB to 2 PB once data taking begins. The computing demands of SoLID are likely to be similar to the GlueX and MOLLER experiments.

4.4.1.2 TRIUMF

The GRIFFIN array at TRIUMF has been designed to perform experiments using radioactive beams, which are produced at ISAC with intensities from 0.01 particles per second to 10^8 particles per second. In the former case, the data collection rates will be small due to the low intensity of the rare isotope beam and typically a few TB per year. In the latter case, with high-intensity rare isotope beams the important physics is often revealed in the observation of very weak gamma-ray transitions from excited nuclear states, which have a relative intensity 5 orders of magnitude lower than the strongest decay branch. The study of these very weak transitions necessitates a very high throughput data acquisition to collect very high-statistics datasets, followed by intensive analysis to identify specific coincidence events. In order to limit the collected data to only the most useful coincidences, the data is filtered for various detector multiplicity and temporal coincidence conditions in real time before being stored on disk. Despite this real-time filtering of the detector signals, the GRIFFIN data acquisition system is capable of writing filtered data at a rate of 300 MB per second and will therefore collect datasets of around 250 TB in typical one-week experimental runs. It is anticipated to perform an average of two of these high-rate runs per year and accumulate 500 TB of new data per year, which will be stored for a minimum of five years while the analysis is completed.

The TIGRESS spectrometer at TRIUMF is utilized in a diverse scientific program in nuclear structure and nuclear astrophysics research. It consists of up to sixteen highly segmented hyper-pure germanium clover detectors, which surround a reaction target where a nuclear reaction is induced by the accelerated radioactive beam from ISAC-II. Charged particles and heavy ions following the reaction are detected in various ancillary detector systems located inside the vacuum chamber at the same time as emitted gamma rays are detected in the TIGRESS detectors. Coincidence triggering conditions between detector sub-systems can be made very selective with such a setup, and due to the typically low intensity of accelerated radioactive ion beams the number of individual events recorded is not as large as in the high-rate decay spectroscopy experiments with GRIFFIN. However, in order to make full use of the position sensitivity of these highly segmented TIGRESS clover detectors it is common to record a short waveform sample from the detector along with the other event data, which is processed in the offline analysis. This waveform collection can increase dramatically the size of the recorded dataset. The TIGRESS digital data acquisition system was custom designed and built as part of the original installation. The full digital data acquisition system is currently being upgraded with the more modern digitizers developed for the GRIFFIN project. Once this new DAQ system is in place, the expected data collection rate will be typically 100 TB per year. The data will be stored for a minimum of five years while the analysis is completed.

TRINAT has utilized Compute Canada parallel processing capabilities for Monte Carlo simulations in the past. It is likely this capability will be needed in the future, particularly as high-statistics measurements become possible.

4.4.1.3 nEXO

While computing resources for nEXO simulations and future data analysis are generally available at LLNL and SLAC, to some level at NERSC, as well as recently by IHEP in China, nEXO anticipates requesting resources from Compute Canada. These resources will support simulations for nEXO and analysis of data once nEXO becomes operational. Resources from Compute Canada will promote the scientific independence of Canadian researchers.

4.4.2 Theoretical nuclear physics requirements

Theoretical nuclear physics has benefited enormously from recent increases in computing power, which has allowed the investigation of many complex problems that previously had to be treated with more approximate techniques. As a result, theoretical nuclear physics has become a major HPC user, on-par with the needs of many experiments.

4.4.2.1 Ab-initio nuclear structure

This TRIUMF-based project involves large-scale *ab-initio* nuclear structure and nuclear reaction calculations, using as input modern two- and three-nucleon forces derived within chiral effective field theory. Using these forces, the quantum many-nucleon problem is solved for bound and unbound eigenstates. It relies on a numerical solution of the quantum many-body problem, which is a CPU/GPU time demanding and memory intensive task, requiring access to large-scale parallel computers. Some of the results discussed in this document were obtained using the INCITE award on the ORNL Titan and Summit supercomputers, Livermore Computing machines, and Compute Canada machines, as well as to TRIUMF Theory cluster. The computing allocation at ORNL is about 20 million core hours per year, and the calculations use up to 6000 nodes (96000 cores). On the LLNL machines, 128 nodes (2048 cores) are typically used, with CPU usage exceeding a million core hours per year. The computing needs will grow in the future, as calculations are performed for heavier nuclei (sd-shell and beyond). Longer-term, alpha-clustering including the scattering and reactions of alpha-particles with nuclei will be calculated. These problems will require a significant increase of computing power, i.e. by a factor of 10 or more. This research would greatly benefit from an exascale machine in Canada, to be competitive with the developments in the US and Europe.

4.4.2.2 Lattice QCD

This is a computational method to obtain a quantitative understanding of strong interactions. Even though QCD is the fundamental interaction governing nuclear physics, little is known about their direct connections and only few *ab-initio* calculations exist. In the past the immense complexity of even the simplest nuclei in terms of quarks and antiquarks was an insurmountable obstacle to lattice calculations. However, recent theoretical developments and increase in computing power have made it possible to compute nuclei up to helium on realistic lattice setups. Pushing these boundaries further and determining the spectrum of light nuclei will give a solid foundation in QCD to nuclear physics. The Canadian lattice QCD effort is centered at York University. Primary resources have included a dedicated cluster of 320 cores at York University and CPU/GPU facilities at the Danish Centre for Scientific Computing. Because the lattice effort at York University is growing and the local dedicated cluster is aging, significant growth in the use of Compute Canada resources, of the order of 4500 core-years of CPU and 100 TB of storage, is anticipated.

4.4.2.3 Quantum Monte Carlo simulations of neutron stars and nuclei

The Guelph theoretical group uses a variety of microscopic *ab-initio* simulation methods to compute the properties of neutron stars and light nuclei. For dilute neutron matter (*s*-wave interactions), the method of choice is diffusion Monte Carlo (DMC). For more complicated nuclear interactions, nuclear Green's Function Monte Carlo (light nuclei) and auxiliary field diffusion Monte Carlo (infinite

matter and medium-mass nuclei) are used. All these methods are exact, modulo the fermion-sign problem and can be extended to become effectively variational methods. These methods use as an ansatz a trial wave function, which embeds sufficient physical insights (from few- or many- body theory) as well as variational parameters, which are systematically varied to approach the state of chosen symmetry.

The computations typically use 100-1000 cores. Over the next 10 years, needs are projected to increase by a factor of 50-100: the biggest issue is the number of particles, N , that can be handled in the simulation. Since the time required scales as N^3 , doubling the number of particles takes 8 times more resources. Neutron-star related systems composed of roughly 100 particles are currently being studied but systems of 400-500 would need to be addressed to be truly realistic. While Compute Canada and other HPC user facilities are important, the availability of guaranteed local computing resources is essential to the continued success of this research program. As such, the Guelph theory group has recently applied for a CFI JELF award to build a HPC facility to accelerate their research. Total project cost: \$452,000.

4.4.2.4 Relativistic quark-gluon plasma

When the nuclear temperature exceeds 170 MeV or about 2 trillion kelvin, the quarks and gluons inside hadrons are liberated to form a quark-gluon plasma (QGP). This new state of matter existed in bulk only when the universe was about a microsecond old. The research focus of the McGill nuclear theory group is the investigation of the ultra-relativistic heavy ion collisions in general, and the properties of the QGP in particular. The computational challenge is to simulate the entire evolution of the ultra-relativistic heavy ion collision, starting from the Lorentz-contracted nuclear initial state, to the QGP phase, and on to the final hadronic state. Each of these steps needs different computing environment: The most CPU-intensive step is the hydrodynamic evolution part, using up to 8 million spatial cells and $\mathcal{O}(10^3)$ time steps, utilizing a parallel computing capability. Another CPU intensive step is the hadronic scattering simulation, where in a typical LHC collision, $\mathcal{O}(10^4)$ hadrons emerge out of the QGP. Keeping track of collisions among these particles is numerically challenging. This part is not parallelized, and requires a massive number of serial nodes since $\mathcal{O}(10^2)$ hadronic simulations need to be performed on each of the $\mathcal{O}(10^3)$ hydrodynamic simulations. Calculations for the outgoing hard and electromagnetic probes have yet different computing needs, requiring a massive storage capability of $\mathcal{O}(10^2)$ TB. It is estimated that at least 2,000 core-years with 3-4 GB/core per year and 250 TB of storage space is required in coming years.

4.4.2.5 Multi-loop effects in precision measurements

A very promising method to search for physics beyond the Standard Model (SM) is to perform high-precision electroweak experiments at the intensity/precision frontier, such as parity-violating Moller scattering, e^+e^- collisions or electron-nucleon scattering. These studies can provide indirect access to physics at multi-TeV scales and play an important complementary role to the LHC research program. These lower-energy experiments tend to be less expensive than experiments at the high-energy colliders, but they are more model-dependent and require significant theoretical input. Thus, in order to match the proposed electroweak experimental precision, it is necessary to provide theoretical predictions on the observables of the SM with 1% precision or better. Since the most of the SM electroweak theoretical predictions employ perturbative expansion in orders of α (fine

structure constant), it will be required to consider contributions to the electroweak cross sections of at least up $\sim \alpha^4$, corresponding to two-loop calculations in the Feynman diagram approach. There has been some success in evaluating higher-order corrections for some specific QED processes, but much work is still to be done for the electroweak sector. Aleksejevs and Barkanova have carried out calculations for a complete set of one-loop electroweak corrections for the e-e scattering and are currently working on computer-algebra based packages for two-loop corrections. However, in the case of electroweak processes, full two-loop calculations face dramatic complications due to the presence of massive vector bosons (W and Z) in the two-loop integrals. For the MOLLER experiment at JLab, the calculation of the parity-violating electroweak asymmetries up to the two-loop level requires the computation of thousands of Feynman diagrams. Based on the assumption that a one loop graph analytical result requires around ~ 5 GB of RAM, about 500 GB of allocated RAM per 100 two-loop graphs are required. Finally, since the first stage of the calculation deals with analytical computations, it is required to store the results permanently, needing of the order of 600 TB of storage. These two-loop calculation techniques can later be adapted for electron-proton processes, electron-positron collisions, and other low-energy experiments involving particles of the SM and new physics.

4.5 Detector development within the Canadian nuclear physics community

Detector technology is a key to discoveries in nuclear physics. There are two types of technological challenges in general, 1) the implementation of a new detector concepts based on an existing technology, and 2) the development of a new technology that leads to a new detector concept. The line between 1) and 2) is blurry, however, because even a solution that has been demonstrated to be effective by a separate group may be hard to replicate. But, in general, 1) is lower risk than 2). Both activities should be supported within the Canadian Subatomic Physics community.

Detector technologies used in the nuclear physics community are very broad, including gas detector and silicon detector for positioning/tracking, germanium, silicon and scintillating detectors for calorimetry (γ and also stopping particles), scintillator for fast timing or for neutron detection. Nevertheless, the implementation of all these technologies requires a combination of precision manufacturing capabilities, and cutting edge expertise in mechanical engineering, electronics engineering and data acquisition system (real-time computing), in addition to specific expertise in detector technology. Support for this exists in Canada from TRIUMF, through the NSERC supported MRS program, and within universities. Enhanced coordination is desirable in order to improve efficiency and capabilities by allowing increased specialization of individuals and sharing work across institutes. As it stands, expertise tends to be broad, but not always very specialized at each institute in order to offer capabilities to tackle any project. TRIUMF, having a bigger group has the most diverse offering of expertise. However, the preferred mode of operation is for TRIUMF to establish synergies with universities. In the next decade, the TRIUMF science technology department is expected to continue supporting the construction of detectors for nuclear physics.

Research and development of a new detection technology is driven by the needs of future experiment. In some cases, the goals an experiment cannot be achieved with the existing technology and new solutions must be developed. For example the nEXO experiment required the development of a new solution for the detection of 175 nm photons, as the solution used in EXO-200 could not be scaled up to the photo-detection area required by nEXO. Such R&D is however very time consuming, because it involves significant risk. In Canada, detector R&D can only be for a few technologies that are sufficiently compelling from the need and interest point of view, to generate critical mass and ensure that Canada can have a competitive edge. Furthermore, technologies with applications outside subatomic physics should be preferred, as they widen the funding sources and strengthen the “benefit to Canadians” claim.

4.5.1 Future Technologies

The list below highlights technologies that appear compelling, with Canada having the possibility of playing a leading role, coupled to a need for future experiments within the Canadian Subatomic community.

1. **Integrated detectors.** The trend of integrating more and more detector and electronics has been on-going for more than 20 years, but it is not having the same successes as monolithic silicon detectors for tracking minimum ionizing particles. This has been mostly driven by the need to minimize materials along the particle path, but it is also relevant when the radioactivity of material may generate background. Canada has some competitive edge with the Teledyne-DALSA facility in Bromont, Quebec that enables the construction of 3D integrated

silicon devices. However, the associated silicon level electronics design capabilities are only available at U. Sherbrooke. Nevertheless, it remains compelling in general.

2. **Solid state detectors.** This covers a wide range of detectors, from germanium used for γ detection, to silicon detectors used for tracking particles. Both technologies are used in nuclear physics. While they are quite different, design tools (sensor level design) and characterization overlap significantly and could be pooled together.
3. **Photo-detectors.** A sub-set of photo-detector is the avalanche diode that also falls in the solid-state category. There is clearly a need for compact and fast (<100 ps timing resolution for single photons) photo-detectors, which cannot be easily achieved by PMTs and has led in part to the rise of the SiPM technology. Nevertheless, PMTs are still the leading application where low dark noise is required. There is a very strong need for enhanced photo-detectors in Canada from μ SR to nEXO to SNO+, to Hyper-Kamiokande. Canada has also a competitive edge with Teledyne-DALSA that manufactures state of the art CCDs and is starting to produce 3D integrated Single Photon AVAlanche Diodes, also called Photon to Digital Converter. Canada has already made substantial investment in the development this solution.
4. **Quantum sensors.** As quantum computing and communication is booming, new technologies are being developed, mostly cryogenic. Some of these technologies appear compelling for nuclear physics, for example for the detection of low energy phenomena in electron capture process. Other examples are in the area of precision symmetry studies with the use of atomic fountain, atom interferometry, and atomic/molecular clock technologies. Canada is investing very significant money in quantum technology, therefore it is an opportunity for SAP contribute to a field where Canada is trying to build a competitive edge.
5. **Machine learning technologies.** Nearly a decade ago, ALPHA-Canada pioneered the use of a Machine Learning (ML) technique in antimatter physics, in the analysis of the first-ever spectroscopy measurement on antihydrogen [Nature 483, 439 (2012)]. The technique is becoming central to many physics analyses, as evident by the recent workshop on Machine Learning held jointly between GlueX and PANDA (Sept 2020) as well as the Artificial Intelligence/Machine Learning Town Hall Meeting at Jefferson Lab (Aug 2020) where 26 ML projects were presented, ranging from FPGA use for fast triggering to unsupervised cauterization in calorimetry. We expect even more widespread application of ML across the nuclear physics community, including theory.

This list of technologies is not exhaustive, and so far the development effort in Canada has not been coordinated. Furthermore, the Canadian funding system does not lend itself well to funding significant R&D effort. In general, grant applications are for solving technological issues pertaining to a specific project. Some exceptions exist. The Photon to Digital Converter development was funded, in part, for the development of next generation liquid argon and liquid xenon experiments that are separate projects, albeit using related technologies. Cross-project funding appears critical for driving the development of potentially ground breaking but expensive technology. In general, this calls for more coordination at the Canadian level. Establishing a technical board bridging both CINP and IPP within the SAP community should be considered. Its role should be to assess technical opportunities and foster collaborations. In addition, the technical board should provide some oversight regarding the technical resources and capabilities available.

As discussed above, resources and capabilities are critical to the success of experiments, even when using demonstrated technologies. Specialization of resources allows the tackling of harder problems, but it comes at the expense of versatility, particularly when the resources are managed at the institutional level rather than the national level. A possible solution would be to have the technical board foster work sharing between the various institutions offering technical resources. In parallel, specific R&D efforts could be fostered mostly by breaking down the barriers between projects.

4.5.2 Applications

Some noteworthy broader applications: TRIUMF is working on a Single Photon Air Analyser for particulate detection in forest fires or for air quality monitoring that is expected to lead to a patent. Two patents are in progress from U.Sherbrooke for the Photon to Digital Converter (PDC). More innovations are foreseen with the development of a new generation of PDC. This PDC should have significant sensitivity in the near infra-red, which would make it compelling for quantum communication and LIDAR applications.

4.5.3 Conclusions

It is important to sustain and enhance the capabilities for detector development and construction in the Canadian SAP community. This requires increased coordination and communication within the community, not only on the level of the scientists but also on the level of engineers and technical staff. To enhance this coordination, TRIUMF proposes to initiate a series of topical workshops related to precision machining, detector design, simulations, and integration, as well as readout electronics and data acquisition systems. Such workshops would enable the sharing of technical expertise and would build strong working level connections between institutions at the technical level.

In any funding scenario, the NSERC subatomic physics envelope needs to continue to allow for such long-term directed research and development for the next generation of nuclear and particle physics experiments.

Chapter 5

The Human Element: Positive impacts on Canadian society

Investments in the Canadian nuclear physics community positively impact society through technological innovations and in the training of Highly Qualified Personnel (HQP). These benefits include, but are not limited to, the diagnosis and treatment of disease through isotope production, radiation therapies, and detector development applicable to dosimetry in medical and space applications. Nuclear physicists, as explorers of the "inner space" frontier, are quite successful in promoting science to the general public. As we explore this new frontier, we endeavor not to repeat the mistakes of the past by acknowledging the need to be proactive in overcoming inequities and to eliminate systemic barriers caused by explicit or unconscious biases, not only because diversity improves research excellence. By participating in a fundamental research project which is technically demanding and contextually fascinating, students have the opportunity to broaden their experience and hone their skills in preparation for the transition to the workforce.

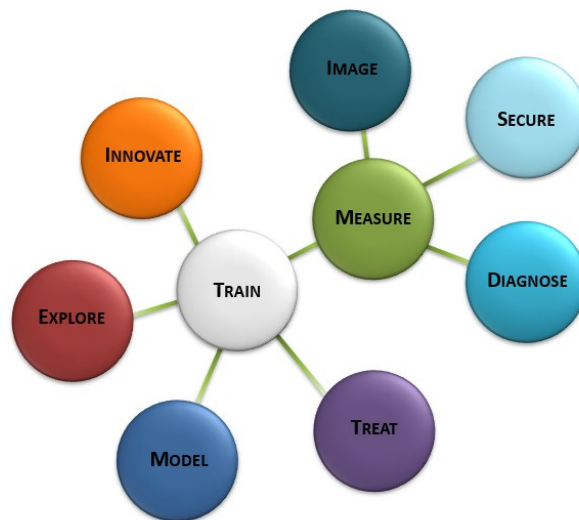

Figure 5.1: Fundamental nuclear research has far-reaching benefits to Canadians.



Figure 5.2: Images of Canadian undergraduate and graduate students and postdoctoral researchers.

The images in Fig. 5.2 are of undergraduate and graduate students, post-doctoral researchers, and a few advisors. These highly qualified personnel come from all over the world, and study at Universities across Canada. In order to successfully complete their work, they must become proficient in a myriad of skills. More information is given below (see image key to right).

1	2	3
6	5	4
7	8	9
10		
11	12	13

1. Undergraduate student Beryl Bell, Sean Vanbergen and Matthew Palmer stacking the final neutron-moderating graphite bricks during the installation of the prototype UCN source.
2. UBC undergraduate student David Cole Bunch with the device used to measure the magnetization of various samples.
3. Undergraduate student Aditya Babu is calibrating the GRIFFIN Spectrometer for future measurements. Photo courtesy of TRIUMF.
4. Regina summer student working on SiPM saturation tests at JLab.
5. Coburg University undergraduate student Fabian Piermaier measuring the field of a large degaussing magnet.
6. Canadian members of the TUCAN collaboration visiting a cryogenic testing facility at KEK, Japan. Left to right: Steve Sidhu (PhD candidate, SFU), Sean Vanbergen (PhD candidate, UBC), Eric Miller (PDF, UBC).
7. Melissa Mitchell(left) and Dr. Taraneh Andalib (right), with the Cs D2 laser used for precision magnetometer development at U. Winnipeg.
8. UBC grad student (then) Andrea Gutierrez transferring liquid helium into the ALPHA experiment at CERN.
9. CINP summer student, Skyler Freeman, constructing the ALPHA-g TPC prototype at the TRIUMF detector facility.
10. Wolfgang Klassen and Nick Masai graduate students at University of Manitoba.
11. PhD student Maedeh Lavvaf and Postdoctoral researcher Mark McCrae (Manitoba) mapping the magnetic field in the area for the future nEDM experiment.
12. D. Muecher and V. Bildstein (Guelph) with postdoctoral researcher Hadi Behnamian and Ph.D. students Eva Kasanda and Christina Burbadge working at TRIUMF.
13. Ph.D. student Satbir Kaur shown working in RIBF Japan. She graduated and took a job as Data Scientist in PEI; received her degree from Dalhousie University.

“During my PhD at Dalhousie University (and Saint Mary’s University) my opportunity to work at international labs (GSI and RIKEN) helped me master critical thinking and problem-solving skills. It helped me master data analysis, data visualization and presentation skills. All these skills are very helpful in projects at my current job as a data scientist at Iwave on Prince Edward Island.”
 Dr. Satbir Kaur (PhD, Dalhousie University), Data Scientist, Iwave, Prince Edward Island

5.1 Equity, Diversity and Inclusion

The CINP applauds the development of the the Dimensions program to increase equity, diversity and inclusion (EDI) in post-secondary institutions, and we agree that diversity, which positively contributes to research excellence, is one of Canada’s strengths. While our current lack of diversity

in the field is a highly complex issue, without any easy solutions, we can make significant contributions toward developing an inclusive climate, providing effective mentoring and coaching, and addressing implicit bias. There is a need for Equity, Diversity and Inclusion (EDI) to promote underrepresented groups in particular women, persons of colour, persons with disabilities and Indigenous People in subatomic physics and related fields. This is a monumental undertaking that involves all of academia, and society as a whole. Nuclear physics research attracts highly qualified people from diverse backgrounds into the country, and our outreach efforts seed the idea of diversity in science to younger generations. The nuclear physics community in Canada recognizes that in order to achieve demographics similar to that of Canada as a whole, there is a need to work to improve EDI, and that measurement is needed to understand our current status and to gauge the effect of actions taken within our community.

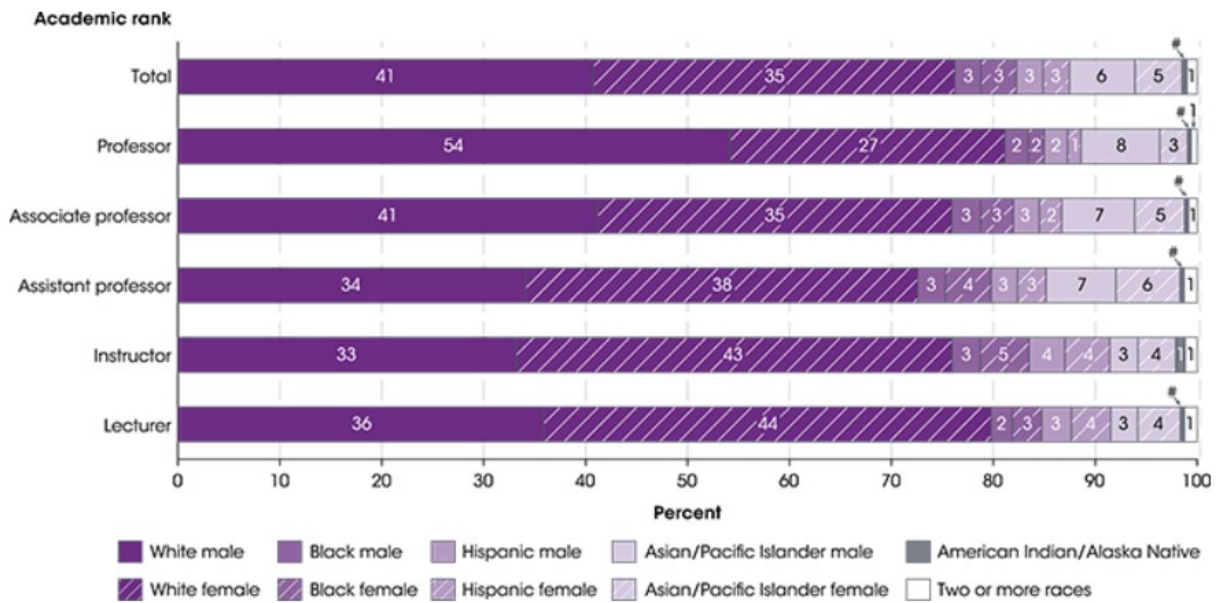

Rounds to zero.

Figure 5.3: The racial/ethnic and sex distribution of faculty varied by academic rank at degree-granting postsecondary institutions in fall 2017. From the U.S. Department of Education, National Center for Education Statistics. (2019). The Condition of Education 2019 (NCES 2019-144).



Figure 5.4: Melissa Anderson as an undergraduate student at the University of Winnipeg. She grew up in Fox Lake Cree Nation and came to Winnipeg when she was 16 years old, and is a mother of three. She worked with Jeff Martin on TUCAN.

“In summer of 2016, I had my first experience working in research. It was with Dr. Jeff Martin, a nuclear physicist and I was awarded an Undergraduate Student Research Award with NSERC. During the summer, I helped with the first design for a magnetic coil to be used with the neutron Electric Dipole Moment experiment at TRIUMF. I learned to use COMSOL software and made several designs during the summer. Also, I used FEA software called FEMM to analyze the designs for the magnetic fields while varying the currents and number of turns to find the most ideal homogeneous magnetic field. During this summer, I learned how it is to work in the research field. Dr. Martin and his team, including the undergraduates and graduate students, would meet once a week to update each other of how your activities are coming along and give each other ideas on what to try. I really liked the environment of how the team worked. When I would need direction with my project, I did not feel intimidated to ask Dr. Martin because I didn’t know how to do something. He was always happy to help or teach me something. I liked how we were all a team and working toward a certain goal with attempting different trials and techniques and learning new things. I knew I wanted to work in this type of field and made my decision to go to graduate school afterward. In the October of that year, I received a travel grant from University of Wisconsin to attend the AIP DNP conference in Vancouver. I was able to go on a tour of the TRIUMF lab. I presented my poster twice at the conference. This experience added to my decision to attend graduate school.”

Melissa Anderson (University of Manitoba, MSc 2022)

As stated in the Dimensions Charter, we also recognize that diversity has many facets, among them parental status/responsibility, ethnicity, socio-economic status and gender. Figure 5.3¹ shows a breakdown of the racial/ethnic and sex of academic faculty (all fields) in the USA. In 2017, 76% of the 1.5 million faculty were white. Note that there are twice as many male full Professors as female, though the ratio is better for the lower ranks. It should be noted that this data includes all fields, and the ratio of female to male faculty in Science, Technology, Engineering and Math (STEM) fields is not as even. It is difficult to find similar statistics for the field of nuclear physics, or even Canadian academic institutions as a whole.

“I learned a lot beyond the scope of research by having a female advisor. I saw a glimpse into the extra work that minority faculty members face in universities (discussed more below). My particular advisor was involved in EDI and outreach programs. One of these programs focuses on bringing indigenous high school students to the University of Manitoba to experience different science programs with the hope of encouraging those individuals to pursue scientific studies. Participating in these outreach programs gave a better understanding of what other people experience within Canada. The importance of outreach programs aimed to increase EDI also became more noticeable.”
Brynne Blaikie (MSc, University of Manitoba, 2022)

According to Statistics Canada², women form a higher proportion of people in post-secondary enrollment (56%), and post-secondary qualifications (51.6%), yet have lower overall labour force participation and employment rates. In 2016, less than 1/5 of leadership roles were held by women. One possibly related statistic is that women still report spending a larger proportion of their time in unpaid domestic and care work compared to men. When we consider STEM fields in particular, we find the proportion of female students was only 44% (compared to 64% in non-STEM fields). We take the view from S. Barkanova³, that “Since there is a significant body of research on factors affecting young women’s career choices, but much less data on Indigenous and rural youth, we build on the common assumption that ‘what works for women works for everyone’, for now.” Indigenous students such as Melissa Anderson (see Fig. 5.4) are interested in nuclear physics, and we need to work to improve the outcomes for these students⁴.

¹https://nces.ed.gov/programs/coe/indicator_csc.asp

²https://www.statcan.gc.ca/eng/topics-start/gender_diversity_and_inclusion

³XXIX International Symposium on Lepton Photon Interactions at High Energies - LeptonPhoton2019 August 5-10, 2019 <https://inspirehep.net/literature/1774988>

⁴<https://news-centre.uwinnipeg.ca/feature-story/physics-student-presents-particle-research-to-world-leading-scientists/>

“I started a PDF at the University of Guelph in September 2013. In 2015 I got a full time joint PDF with the support of Paul Garrett at the University of Guelph, Iris Dillmann at TRIUMF, and Luis Lehner at the Perimeter Institute for Theoretical Physics. These positions gave me the opportunity to enhance my expertise, start new collaborations in Canada, supervise HQP, and build an independent research program. In 2015 I received adjunct faculty status at Guelph, which allowed me to apply for my first NSERC Discovery Grant in 2015. Through this funding I was promoted to Assistant Professor under a contractual limited appointment. In 2019 I was converted to a tenure-track faculty position. In 2020 I successfully renewed my NSERC DG. Since my first appointment at Guelph I have supervised more than 15 students, taught at the undergraduate and graduate levels, support under-represented groups in our Department, and maintain a vibrant research program in theoretical nuclear astrophysics.”

Dr. Liliana Caballero (PDF, University of Guelph), Assistant Professor, University of Guelph, Ontario

Recruitment plays a critical part of improving EDI. Advertisements are designed to reach a broad and diverse candidate pool that includes members of underrepresented groups such as visible minorities, women, people with disabilities, indigenous peoples, and members of the LGBTQ2+ community. Care is taken to avoid biased or gendered language in the text of ads, as well as to avoid implicit and explicit biases in the selection and interview processes. A number of groups require interviewers to complete the Canada Research Chair Unconscious Bias training module⁵. In order to improve recruitment, we need to be able to demonstrate a welcoming work environment.

To this end, it would be beneficial to foster an inclusive working environment, provide support for childcare via flexible working hours and locations, as well as accommodation of working styles and caregiver responsibilities. The development of online work and training opportunities triggered by the COVID-19 situation could be seen as a test of telecommuting as a way to provide an inclusive environment. Online technology and automation can support research of persons with limited functional mobility as well. As a resource for the nuclear physics community in Canada, part of the TRIUMF values⁶ is ‘Equity & Inclusion’ - where the importance of empowerment, an inclusive work environment, teamwork and open communication is recognized as necessary to ensure that everyone belongs and all voices are heard. The goal is to respect each other, take care of each other, and support the success of all.

⁵<https://www.chairschaires.gc.ca/program-programme/equity-equite/bias/module-eng.aspx?>

⁶<https://fiveyearplan.triumf.ca/about-triumf/vision-mission-values/>

“One of the advantages of performing my graduate studies at Simon Fraser University is that I had direct access to TRIUMF. This allowed me to not only preform my own research, but I was able to participate in numerous other experiments. Additionally, I got to observe the day to day workings at TRIUMF that not only include preparations for upcoming experiments, but also preparations for long-term advancements as the beginnings of ARIEL were in the works. My experiences at Simon Fraser and at TRIUMF prepared me for the work that I am doing now as a Project Scientist at Lawrence Berkeley National Laboratory. I know how to utilize all of the resources that are at my disposal. I also recognize the importance of building strong collaborations with fellow researches both locally and at other institutions to create the necessary support to generate a solid scientific program. I feel confident in my career moving forward.”

Dr. Jennifer Pore (PhD, Simon-Fraser University, 2016), Project Scientist, Lawrence Berkeley National Laboratory, Berkeley, California

As part of our commitment to improve EDI in the nuclear physics community, the CINP Board unanimously approved a Policy on Equity, Diversity and Inclusion on September 19, 2019. The policy is as follows: “The CINP is committed to ensuring equitable access to its resources and promoting equity, diversity and inclusion in the nuclear physics community in Canada, recognizing that this will contribute to more robust research and education outcomes” The board also plans to officially modify the Education and Training Scientific Working Group Terms of Reference to include issues related to EDI. Among the proposed additional goals are to promote equity, diversity and inclusion in accord with the CINP Policy, to provide information about EDI training opportunities to the CINP members, and to collect and report data regarding EDI within the Canadian Nuclear Physics community. In addition, the CINP will explore the possibility of endorsing the Dimensions Charter as a professional organization and is formulating plans to reach out to CAISES - Canadian American Indian Science and Engineering Society. We are exploring the possibility of a scholarship for underrepresented minorities without violating the relevant Human Rights Codes. We recommend that a joint survey with IPP for demographics of SAP community - initially as part of LRP process, but also as an ongoing endeavor to understand the effectiveness of our efforts to improve EDI.

5.2 Outreach

Outreach is an essential element in increasing overall enrollments in STEM fields, as well as improving equity, diversity and inclusion in academia and in nuclear physics in particular. To paraphrase Bloom’s Taxonomy of learning domains (cognitive, psychomotor and affective) , we must appeal to three aspects of our (future) students - knowledge, skills and attitude. Outreach is an opportunity not only to impart interesting facts, and to provide the opportunity to try something new, but perhaps most importantly, to influence the feelings of the public toward science. This can be particularly important for underrepresented minorities, who may not “see” themselves in a particular field, which can influence their ability to succeed in that field. Astrophysics and nuclear and particle physics are fascinating and provide a wide range of excellent public engagement opportunities. The subatomic physics community has a large percentage of researchers that participate in outreach activities, including participation in existing programs such as the Verna J. Kirkness Program, per-

forming demonstrations for classes in their local schools, such as the “Science Kids on Campus at the University of Winnipeg” or youth groups like Girl Guides. Some have even spearheaded their own efforts, such as the integrative approach to STEM outreach by combining science and culture led by Dr. Barkanova, a professor at Grenfell campus of Memorial University of Newfoundland in Corner Brook. We will highlight the Kirkness Program and Dr. Barkanova’s work.



Figure 5.5: A Physics outreach event with Girl Guides at MUN.

The Verna J. Kirkness Program⁷ is dedicated to “Increasing the number of First Nations, Métis and Inuit students graduating from science and engineering programs in Canada.” This program brings Indigenous high-school students into the research lab during the summer months and gives them a taste of how actual science is done. It is an excellent experience for both the high-school students and the scientists, who in this case are both younger students and senior researchers. It has a positive impact in both outreach by fostering ties between the university and community, and has the potential to encourage Indigenous high-school students to attend university and study science, and possibly even physics. Dr. Juliette Mammei has hosted students as part of this program every year since she began as an assistant professor at the University of Manitoba, nearly as long as the program has been going on at the university. She designed a curriculum of table-top experiments to introduce the students to nuclear physics. Among other things, the students determine both the charge and the mass of an electron via the Millikan Oil Drop experiment and the Thomson e/m experiment. The week culminates with the construction of a cloud chamber which the students use to detect cosmic rays. Other institutions around the country are also considering participation with a nuclear physics program.

⁷<http://www.vernakirkness.org/>

“I’m currently a PhD candidate in the Netherlands using a supercomputer to simulate the atmospheric boundary layer and large-scale wind farms. However, my first research projects were in subatomic physics, with NSERC/IPP/CERN summer awards. Though the physics I do now is more applied, I wouldn’t be here without the foundation that I received at the Grenfell campus of the Memorial University of Newfoundland. The professors always had an open door, put in the time, and genuinely wanted us to succeed. Not only did I gain research and computing skills which I use to this day, but I also learned that great things were not out of reach.”

Jessica Strickland (B.Sc. Memorial University, Grenfell), PhD candidate at University of Twente, Netherlands

Another example is the LGBTQ+ advocacy of Dr. Wouter Deconinck, also in the Manitoba group. Since 2009, Deconinck has been an effective ally for LGBTQ+ physicists. As a long-time organizing member of the LGTB+Physicists organization, Deconinck regularly leads roundtables and mentoring events for gender and sexual minorities at the annual meetings of the APS and at other conferences. He co-authored the 2012 “LGBT+ Best Practices Guide for Physics and Astronomy Departments” and the 2016 APS report “LGBT Climate in Physics: Building an Inclusive Community”, the first comprehensive study of the climate faced by LGBTQ+ physicists at various stages in their career. At the University of Manitoba, Deconinck is the chair of the Departmental Equity, Diversity and Inclusion committee.

“They are the only two subatomic physicists in the province, both at Grenfell Campus of Memorial University of Newfoundland, and I was lucky to have them as my mentors. Drs. Aleksejevs and Barkanova classroom environment allows students to be comfortable and develop confidence, along with the aspiration to become physicists. They encourage their students to network extensively and provide research opportunities funded from all kinds of sources such as NSERC, CINF and IPP summer scholarships.

As an Indigenous student, being funded for the summer has brought me incredible research and learning opportunities such as working to develop theory input for an experiment at Jefferson Lab. Being a minority in the field can be sometimes difficult, but with the guidance of Dr. Aleksejevs and Dr. Barkanova, who is also a huge advocate for women within the STEM community, there has been an increase in the number of research opportunities and the number of physics students, so I feel much more like a part of a team now.”

Nicholas O’Neil (student, Memorial University, Grenfell)

A high percentage of MUN students are Indigenous, especially in Corner Brook (a home to Grenfell Campus of MUN) which has 24% Indigenous population, and many of them have been helping with science outreach activities. The program led by Dr. Barkanova, a professor at Grenfell campus of Memorial University of Newfoundland in Corner Brook is performed in partnership with NSERC PromoScience, Qalipu First Nation, Parks Canada, and NL Hydro⁸. The main goal is to promote physics to Indigenous students, girls, and rural youth in Newfoundland. The team welcomes underrepresented youth on campus, leads events in parks, visits rural schools, and

⁸XXIX International Symposium on Lepton Photon Interactions at High Energies - LeptonPhoton2019 August 5-10, 2019 <https://inspirehep.net/literature/1774988>

hosts webinars with a diverse group of speakers. The team also develops resources for teachers and coordinate the science outreach content with the existing provincial school curriculum aiming to include more subatomic physics content. The partners from Qalipu First Nation, one of the largest First Nation groups in Canada and the community partners on this science-outreach project, collect and incorporate relevant Indigenous knowledge such as stories related to the sky, help with networking, and collaborate on school visits and public events. From May 2021, Grenfell campus of MUN will also join Kirkness program, providing an opportunity for reciprocated learning experiences between High School Indigenous students from western Newfoundland and Labrador and Grenfell students and researchers in science, engineering and the social sciences. Dr. Barkanova notes, however, that while their science outreach activities are well-funded (thanks to NSERC PromoScience Grant and community and industry partners), they are struggling to find enough funding for their graduate students and postdocs, with many excellent candidates from equity-seeking groups being rejected due to budgetary constraints.

5.3 Overview of the skills acquired in nuclear physics training

Low and intermediate-energy nuclear physics experiments provide an ideal training ground for producing the technically savvy future generations of innovators. These smaller scale experiments give graduate students the opportunity to participate more fully in the overall experiment. They have a larger role in the collaboration, have the opportunity to gain experience with all aspects of the project, including the design, simulation, hardware development, measurement and data analysis. Due to the shorter time scale of nuclear physics experiments, students often get to participate in nearly every stage of the project, from conception to final results, and often take on leadership roles within the collaboration. In the process of building and running new facilities, designing and performing experiments and interpreting data, future scientists and engineers receive the training necessary to generate new ideas. This approach also cultivates valuable leadership skills.

“In the four years since I joined Canadian Nuclear Laboratories (CNL) as a research scientist, I have contributed to a wide range of projects, such as reactor physics experiments, neutron scattering experiments, muon tomography, neutron generator and detector design, probabilistic safety analysis, and studies of isotopic signatures for nuclear fuels. My work has applications in nuclear safety, security, and non-proliferation, as well as the operation, maintenance, and design of nuclear reactors. I had no direct experience in any of these subjects when I started work at CNL in 2016; my prior research experience had focused on modelling high-order corrections to nuclear processes (Acadia University 2007, TRIUMF 2008-2009) and Beyond-the-Standard-Model theories of the Higgs boson and dark matter (Carleton University 2009-2015). However, while the subject of analytical and computational modelling may change, the required skillset remains the same. My experience in theoretical nuclear and high-energy particle physics research allowed me to develop an adaptable skillset including: a broad spectrum of high-level physics, mathematics, and statistics; analytical modelling and algorithm development; programming, simulation, and analysis techniques; communication, leadership, teamwork, mentoring, and international collaboration.”

Dr. Katy Hartling (PhD, Carleton University), Research Scientist, Computational Techniques Branch, Canadian Nuclear Laboratories

As an example, consider Dr. Thomas McElroy (PDF, McGill, transitioning to U. Alberta) who has been leading the development of the LoLX project. He co-organized the first LoLX collaboration meeting and he pushed design and construction of LoLX Phase-I. In May 2020, to help students cope with the CORONA situation and prepare them for a summer of remote research projects. Thomas organized a Canada-wide online training for incoming summer students to help them get started with their summer projects. In total 271 students registered for these training sessions, and typically 150-200 students attended each lecture. Thomas recruited excellent teachers for these lectures such as the 2019 CAP-TRIUMF Vogt Medal recipient Dr. Scott Oser. The event was broadly advertised to the community by CINP, IPP, and CAP DPP.

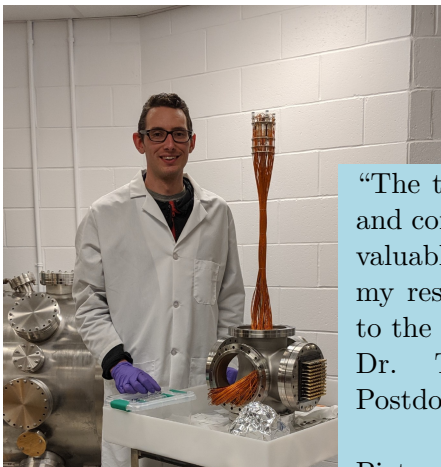

“The training in nuclear physics that I received in grad school and continued through my postdoctoral research has given me a valuable knowledge base. This knowledge allows me to broaden my research scope and strengthen my abilities in contributing to the next generation of rare event searches.”
Dr. Thomas McElroy (PhD, University of Alberta, 2018),
Postdoctoral Researcher, University of Alberta

Picture at left: Dr. McElroy in the Brunner Neutrino Lab (McGill University) next to the assembled LoLX detector.

Highly qualified personnel trained in nuclear physics go on to be responsible for discoveries and technologies that will have an impact on our society in future, including significant roles in addressing societal demands on energy production and pollution reduction through development of new nuclear power plants. Nuclear physics has led to many advances in computing, imaging for medical diagnosis and other applications as well as treatment of cancer with radiotherapy. Students are trained with advanced computing techniques such as machine learning, and they will be trained to use quantum computers as they become available.

In the study of nuclear physics, students become proficient in a wide variety of skills in addition to acquiring knowledge related to various fields such as chemistry, electricity, high vacuum and computer systems. Examples of some types of skills include those listed in Figure 5.6. Many students go on to successful careers as professors or staff scientists at national and international facilities, while others leverage these skills in positions outside of academia in industries such as nuclear power, medical physics and even finance. Some recent graduates from the ALPHA program, for example, have gone into the field of Data Science, Oceanography modelling and Science Communications.

In addition to the hard skills described above, training in nuclear physics requires the development of a number of “soft” skills that are essential to success in the workplace of tomorrow. The World Economic Forum released the Future of Jobs Report in January 2016⁹, The report summarized the annual meeting which had a theme of “Mastering the Fourth Industrial Revolu-

⁹<https://www.weforum.org/reports/the-future-of-jobs>

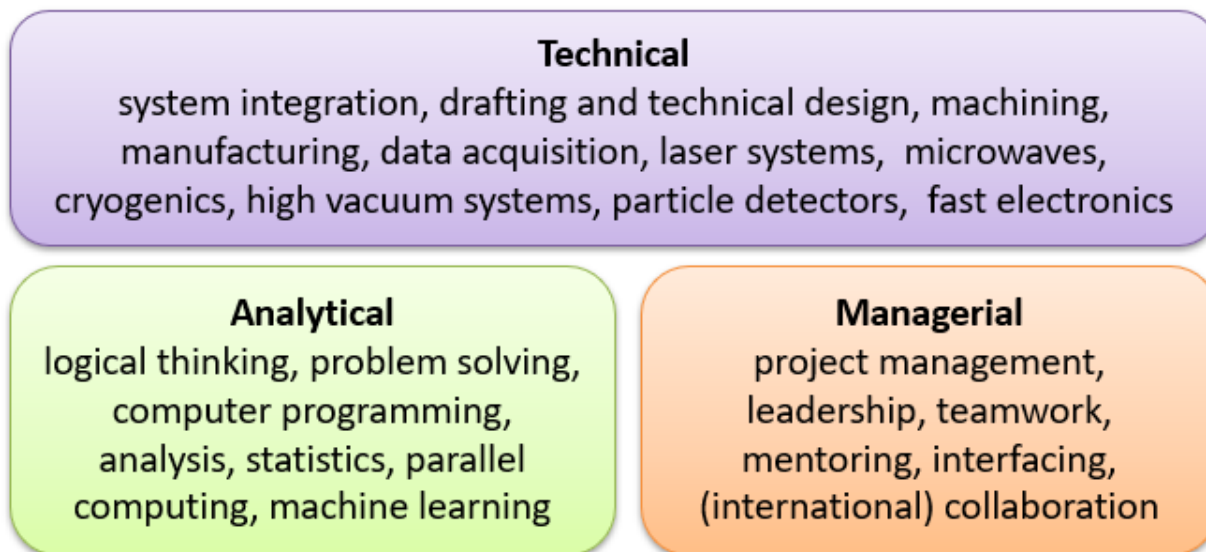

Figure 5.6: Non-exhaustive summary of skills gained during training in nuclear physics research.

tion”. Chief human resources and strategy officers from leading global employers reported on the changing economy and provided a comparison of the most desired skills in 2015 compared to those which would be required by 2020. Complex problem solving, critical thinking, creativity, people management, coordinating with others. judgement and decision making, negotiation and service orientation appear on both lists. As the workplace evolves, emotional intelligence and cognitive flexibility are deemed to become more important than quality control and active listening.

“During my 3 years as a postdoctoral fellow at TRIUMF I have been part of the Gamma Spectroscopy Group, focusing on the decay station GRIFFIN. As one of the senior PDF of the group, I was in charge of supervising a small group of graduate and undergraduate students that worked on my own research program. This has given me extensive supervision and management skill and a taste of what it means leading a research group. The experience acquired at TRIUMF has allowed me to obtain a prestigious CERN fellowship. When I move to ISOLDE-CERN, I will be in charge of the ISOLDE Superconducting Solenoid, where I will continue with my program researching the nuclear structure of exotic isotopes.”

Dr. Bruno Olaizola (PDF, TRIUMF), CERN Fellowship, CERN, Geneva, Switzerland

The scale of projects in nuclear physics is often such that graduate students can be involved with “negotiation” and acquisition of parts/services. They are also trained in technical/scientific writing and presentation. Students are trained in scientific ethics. By including our HQP in outreach efforts, they also learn to support EDI.

5.4 Canadians in nuclear physics

Canadian researchers in nuclear physics have the skills and training to participate in a wide variety of applications. Due to their training and background, Canadian nuclear physicists were able to quickly respond to the challenges presented by the COVID-19 pandemic by developing low-cost ventilators¹⁰, using their 3D printers to create face shields for hospital workers¹¹, and data modeling of COVID-19¹².

As a part of our consultations for the Canadian Subatomic Physics Long Range Plan, the Canadian Institute of Nuclear Physics (CINP) requested information from the nuclear physics community to gauge the dynamics and the demographics of the field in respect to the education and training of new personnel in the period of 2015-2019. PIs from 33 projects, representing 75 faculty members from 19 universities and TRIUMF, submitted relevant information on HQP training as requested by CINP. Not all departments responded, and in some cases it was not clear that the responses were comprehensive. An active faculty is considered a faculty member that is engaged in an ongoing research program, either in a group or on their own, and can include emeritus professors. Undergraduate and graduate students considered are either funded by Canadian sources (NSERC or otherwise) or primarily supervised by Canadian investigators. There have been 11 new faculty hires in the last 5 years - 3 at TRIUMF, and 8 at Universities (Acadia, Guelph, Manitoba, McGill, North Island College (BC), Regina, and St. Mary's) - reflecting a growth and renewal of our community. In addition, as Figure 5.7 shows, there has been an increase in interest in nuclear physics at universities and TRIUMF.

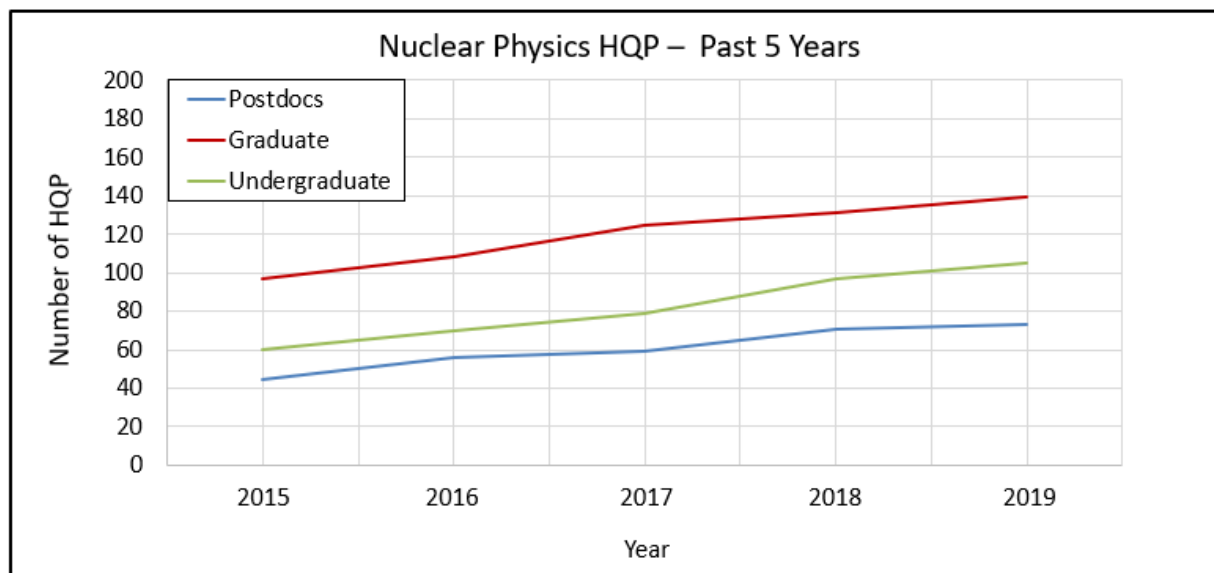

Figure 5.7: Plot of the number of highly qualified personnel receiving training in a given year for the period of 2015-2019. The numbers are for personnel either funded by Canadian sources (NSERC or otherwise) or primarily supervised by Canadian investigators.

¹⁰<https://www.queensu.ca/gazette/stories/easy-build-ventilators>

¹¹<https://leaderpost.com/news/local-news/university-of-regina-offers-to-make-face-shield-headbands-using-3d-printer>

¹²https://events.uvic.ca/physics/view/event/event_id/49979

Much of the growth in this period is due to the completion of several large facility upgrades and/or new experiments (ARIEL, nEXO, γ -Ray Group, TUCAN) and is expected to continue (perhaps at a slower rate) as other large facility upgrades are completed and major new experiments ramp up (12 GeV JLab, MOLLER). Nearly all the groups had at least constant or modest growth in the number of HQP. In particular, the number of highly qualified personnel being trained at ARIEL has doubled over the past period, and those in TRIUMF theory have nearly tripled. The number of students and other HQP working on TUCAN has remained strong at about 30 people as well. There are also some relatively new projects such as EMMA, MOLLER, EIC and muon g-2 that have begun training but have not yet reached their minimum level of personnel. Based on this trend and the scientific potential, it would be beneficial to continue the hiring of new faculty to replace members of our community that have recently retired and to capitalize on the new upgrades at TRIUMF and abroad. The observed trends are certainly encouraging and indicate a dynamic field, committed to training of highly qualified personnel through research.

5.5 Benefits to Canadians

Nuclear physics has produced a host of technologies that are now used as tools in many scientific disciplines, but also in more ordinary applications such as imaging technologies in medicine, cancer treatments, sterilization of blood and other medical items, oil-well logging, ion implantation of semiconductors, the most common type of smoke detectors, forensic analysis, monitoring cargo for contraband, and of course commercial power generation. Photon sensor development may be used for LIDAR and in devices for wild fire/smoke detection, detector technologies may be used at border crossings to prevent the smuggling of radioactive substances and other national security/non-proliferation applications (e.g. are reactors being run cleanly, how truthfully did North Korea report their nuclear capabilities, where was radioactive items/material stolen from). Nuclear physicists serve as science advisors to politicians and funding agencies around the world.

Accelerator production is a \$2 billion industry, with 1000 accelerators sold yearly for applications ranging from semiconductor processing, producing short-lived isotopes for medical imaging, accelerator mass spectrometry, and for radiation therapy. The collective value of the products made using accelerator technology, including isotopes used in determining the age and origin of materials, studying the behavior of defects and impurities of materials, and medical applications has been estimated at more than \$500 billion per annum [Physics Today 64, 46 (2011)]. Canada is one of six countries worldwide that can produce the superconducting radio-frequency (SRF) cavities needed in particle accelerators which have applications, not only for nuclear physics research at facilities like TRIUMF, but also in the energy, defence, aviation, aerospace and research industries to provide very precise metal-welding services using electron beams, and in environmental protection by replacing chemicals with electrons to treat flue gas that is emitted by coal-burning power plants.

Another example is Canada's long history of achievements in nuclear energy. CANDU reactors were developed in the 1950's and 60's and the design is still used today. Canadian nuclear researchers have taken a leading role in a recently initiated International Atomic Energy Agency Coordinated Research Project for the "Development of a Reference Database for Beta-Delayed Neutron Emission" which has, among its research objectives, the goal to re-evaluate the beta-delayed neutron reactor constants in appropriate group format for energy applications and produce the recommended database. Nuclear energy from accelerator driven reactors and waste/transmutation are possible future advancements to nuclear power.

Many of the developments in nuclear physics have far-reaching impacts. In some cases we are

not able to predict what those impacts will be. However, there are many applications with active collaboration of Canadian nuclear physicists. Some examples include:

- Jens Lassen (TRIUMF), Peter Kunz (TRIUMF) and Corina Andreiou (SFU) have an NFRF grant approved to investigate thorium target material for medical isotope production
- Dennis Muecher (Guelph) and Connie Hoehr (TRIUMF Life Sciences) have an NFRF grant to improve range verification in proton/hadron cancer therapy via gamma-ray spectroscopy techniques
- Thomas Brunner (McGill) collaborating with a group at Sherbrooke to study the possibility of using the light emission properties in liquid Xe for rare event searches (nEXO) for medical imaging in PET
- Kris Starosta (SFU) and Joe Mildenerger (TRIUMF) are working in environmental/occupational safety such as developing shielding against prompt or non-prompt radioactive sources, performing post-Fukushima tracing (e.g.)
- Ania Kwiatkowski (TRIUMF) and Mike Wieser (Calgary) are studying water & atmospheric flow/tracking with radioactive isotope tracing

These are just a few of the ways that fundamental nuclear physics research in Canada has had a substantial impact on society at large.

5.6 Summary

Nuclear physics has and will continue to provide a broad range of benefits to society from the training of HQP to nuclear power, medical diagnostics and treatment. Technological advances made to further our understanding of the fundamental nature of matter have produced tools used by nearly every other scientific discipline. Innovations in detector and accelerator design will continue to impact medical, security and space applications.

“I joined the Applied Physics branch at CNL in January of 2016, following completion of my Ph.D. in Physics at the University of Guelph. My Ph.D. work focused on studying the nuclear structure of Hg-200 through elastic and inelastic transfer reactions using accelerated beams of deuterons provided by the Maier-Leibnitz Laboratory, in Garching, Germany. Currently, my primary research at CNL is in the area of nuclear safety and security, focused on advancing radiation technologies for border security and nuclear non-proliferation. This includes, but is not limited to, the development, improvement and validation of muon tomography detectors and algorithms for the detection of shielded special nuclear materials and the exploration of using disruptive liquid argon detector technology for the screening of cargo containers at Canadian borders. In addition to this, I have ongoing research in the area of nuclear energy and reactor physics. This research employs CNL’s ZED-2 reactor, a versatile heavy water moderated low power research reactor.”

Dr. Evan Rand (PhD, University of Guelph, 2016), Applied Scientist, Canadian Nuclear Laboratories, Chalk River, Ontario

The Milano Ventilatore Meccanico (MVM) Project

In response to the global COVID-19 pandemic, the MVM Collaboration^a, an international collaboration of national subatomic physics laboratories from Italy, Canada, the United States, and other countries, has leveraged its collective expertise in the design of gas handling and electronic control systems to develop an appropriate ventilator for both mandatory and assisted ventilation^b. The simplicity of the design, which is made possible by the MVM sophisticated control system, allows for ease of availability of parts, and rapid manufacturing in differing countries.

Guided by medical experts and in cooperation with industrial partners Elemaster in Italy as well as Vexos^c and JMP Solutions in Canada, the MVM Collaboration has succeeded - in record time - to design, develop, build and certify a safe ventilator that is powerful, yet gentle, on the lungs. The project started in late March 2020 and within 6 weeks the design received Emergency Use Authorization by the US FDA. In Canada the effort is led by Nobel laureate Art McDonald, involving team members from Canadian Nuclear Laboratories Chalk River, McDonald Institute, SNOLAB, and TRIUMF.

The rapid development was only possible due to the almost around the clock work of a large team working across nine time zones, enabling effective hand-off and progress on the various development tasks. On September 30, 2020, the MVM received approval by Health Canada under the Interim Order and Vexos started to deliver the 10,000 units that have been ordered by the Federal Government of Canada. The MVM development is a prime example of how the expertise of nuclear and particle physicists - who are trying to unravel the mysteries of the foundations of the Universe - can be effectively mobilized in real time to the benefit of tremendous challenges to our global society.



Figure 5.8: Pictures from the MVM Tests at TRIUMF. (Top) Connor Natzke (Colorado School of Mines/ TRIUMF), Victoria Vedia (TRIUMF); (Bottom) Nicolas Massacret (TRIUMF); Rebeka Lubna (front, TRIUMF).

^a<https://mvm.care/>

^b<https://arxiv.org/pdf/2003.10405.pdf>

^c<https://www.vexos.com/mvm-ventilator>

Chapter 6

Recommendations and Budgetary Estimates

In this chapter, we present our detailed recommendations and budgetary estimates for prioritized endeavors. The recommendations and budgetary estimates follow from our nuclear physics community consultations, where we asked investigators to indicate the funding ranges needed for a restrained, yet efficient, contribution to scientific endeavors, as well as levels that would enable a more extensive contribution. This chapter is divided into two parts. Sec. 6.1 describes our recommendations in detail, Sec. 6.2 presents the budgetary estimates needed to implement many of the recommendations.

Chapter 5 summarized clearly the growth in the nuclear physics community, and this brief in its entirety has demonstrated the breadth and dynamism of the research being conducted. Coupled together, there is little doubt that operating and capital funds must grow in coming years to ensure that Canadian researchers maintain a world-leading position in this field.

6.1 Major recommendations

Recommendation 1: Enhance nuclear theory support

The advancement of nuclear physics is strongly dependent on the interplay between theory and experiment. Nuclear theory is indispensable for interpretation of experiments testing beyond the standard model physics that involve atomic nuclei such as measurements of neutrinoless double beta decay, tests of CKM unitarity in beta decays, measurements of nuclear electric dipole and anapole moments. Similarly, nuclear theory is crucial in extrapolations and evaluations of cross sections of nuclear reaction important for astrophysics that cannot be typically measured at low energies relevant for astrophysics processes. For the quickly-developing precision frontier which can reach for new physics at TeV scale, theory input is indispensable. For example, nuclear corrections are still the largest systematic uncertainty in neutrino oscillation data. In addition to predictive first-principles (*ab-initio*) and phenomenological modeling, theorists identify promising future directions for the experimental programs, participate in experimental proposals, develop new computational methodology, help to interpret the experimental data, and educate the future generation of researchers in both theory and experiment. The key to successful collaboration between

theory and experiment in such areas is close coordination and rapid theory response to the needs of experimental programs. At the same time, excellence in theory depends on diversity of ideas and people, and it is essential to support a wide range of theoretical programs in all regions of Canada. We recommend an increased support for nuclear theory researchers at a level that is sufficient for faculty members to allow travel and also to support postdocs and graduate students.

The efforts of nuclear theorists in Canada are already well-aligned with the strengths of the Canadian experimental research in nuclear physics, and new facilities such as EIC and ARIEL will provide a great opportunity to strengthen and grow this program further. Nuclear theory is one of the very few fields where a modest infusion of new funds will see a substantial return in research productivity and results.

We recommend strategic investment into nuclear theory HQP, especially postdocs, who can accelerate the efforts of these recognized world leaders at the fore-front of an exciting and fast-moving field. Budgetary estimates are in Sec. 6.2.2.

Recommendation 2: Maintain a diverse program of excellence in experimental and theoretical nuclear physics research.

Nuclear physics addresses many of the most important scientific questions which exist today. We have listed in Chapter 1 what are considered internationally the key open questions in nuclear physics research today. By making best use of its established expertise and strengths, and seeking to contribute to the fields of greatest scientific opportunity, the Canadian nuclear physics research community has self-selected where to best concentrate its efforts. In Chapter 3, we have shown how the Canadian research effort contributes to our better understanding of the solution to these key questions, and the field is dynamic, with the community moving its manpower and resources to the inquiries of highest scientific priority.

Despite this natural evolution and concentration of efforts, we caution that it is important to not make the Canadian research contributions too narrow. Nuclear physics is a many-body problem, and history has shown that it is not possible to predict where the next breakthrough will come from. Surprises have come from what might otherwise have been considered to be straightforward measurements, and advances towards the solution of one major question often lead from progress in a complementary area.

For example, many searches for physics beyond the Standard Model depend on detailed knowledge of nuclear matrix elements, and hence the field of fundamental symmetries depends greatly on knowledge of nuclear structure. In the astrophysical regime, the determination of neutron star properties relies greatly on knowledge of the QCD equation of state. There are also deep connections between the fields of nuclear structure and nuclear astrophysics, particularly for a better understanding of the r -process abundance distribution, and also between nuclear structure and QCD, such as making the elusive connection between the $N - N$ potential mediated by mesons and the residual quark-gluon colour force.

Canadian participation and leadership in scientific experiments and developments at offshore rare isotope facilities should continue to be supported. Canadian researchers have successful scientific programs and are building detectors for various RIB facilities, including the new major in-flight facilities at NSCL/FRIB in the USA and GSI/FAIR in Germany, which enable a complementary science program to ISAC/ARIEL.

We strongly recommend that a diverse program of experimental and theoretical research excellence addressing all of the key questions of nuclear physics be maintained in all funding scenarios.

Recommendation 3: Fund the additional HQP needed to capitalize on new or recently-upgraded facilities

Substantive progress towards the resolution of the key questions in nuclear physics requires highly qualified personnel (HQP), including undergraduate and graduate students, postdoctoral fellows (PDFs) and technical staff. Despite this clear need, the community survey undertaken in the 2017–2021 Long Range Plan indicated that the subatomic physics community “*has the capacity to train about 80% more students, if additional funding were available*”¹. This underutilized supervisory capacity was broad-based across all sub-disciplines of subatomic physics, and leads to lost innovation benefits to Canada. Subatomic physics HQP generate the innovative ideas used to design, build, and operate experiments and facilities, devise improved algorithms to analyze collected data, and create the numerical simulations to interface theoretical models with measurement data. After graduation, the wide range of highly-valuable skills they gain from training in nuclear physics allows them contribute to Canadian innovation economy in multiple areas related to science and technology.

Recent strategic investments have enabled the development of several major new experimental facilities, with further planned investments described in Table 6.2. The experimental studies enabled by these new facilities have very high scientific merit, and Canadians are well-placed to take advantage of these opportunities. *It is essential that a corresponding increase be made to the NSERC Subatomic Physics envelope to support the research teams that will drive the scientific output from these new facilities.* Budgetary estimates are in Sec. 6.2.2.

Several examples of new facilities that will benefit from enhanced HQP include:

- At ISAC, CANREB beams are coming online, and new detectors have or are nearing completion such as: the Electromagnetic Mass Analyser (EMMA) vacuum-mode recoil mass spectrometer (ramping up after first experiments in 2019), and the proposed Radioactive Molecules for Fundamental Physics (RAMS) facility.
- The TRIUMF Ultra Cold Neutron EDM experiment has been quickly ramping up its activity, with the upgraded EDM experiment projected to be assembled in 2023, with running occurring for the next two to three years thereafter.
- The DOE recently approved Critical Decision 0 (Mission Need) for a tonne-scale $0\nu\beta\beta$ experiment, for which nEXO at SNOLAB is a strong candidate. There has been significant Canadian leadership in EXO-200, and nEXO would be a major opportunity for future Canadian leadership.
- In the USA, the Jefferson Lab 12 GeV upgrade is now complete, and Canadians are finally starting to see the fruits of their work in terms of high quality new data.
- At CERN, the ALPHA-Canada Collaboration is embarking on a large expansion of its scientific program, with a focus on the two highest priority projects – ALPHA-g and HAICU. Additional funds would allow them to take a greater role in other important programs, such as precision spectroscopy with the ALPHA-3 apparatus.

¹Canadian Subatomic Physics Long Range Plan 2017–2021, p.76

The experimental studies enabled by these new facilities have very high scientific merit, as otherwise the cases for building them could not have been successfully made. Full scientific exploitation of these opportunities will require corresponding increases in investment, particularly for HQP. Unless new investments of this nature are made, the Canadian nuclear physics community could ultimately find itself unable to capitalize on the new scientific opportunities provided by the major capital investments which have been made in world-class experimental equipment.

Recommendation 4: Leverage the scientific opportunities enabled by the completion of ARIEL

The Advanced Rare IsotopE Laboratory (ARIEL) is TRIUMF's flagship project, conceived to ensure Canada's leadership role in rare isotope science. During the period covered by the forthcoming Long Range Plan, ARIEL will move from construction to delivering science in a phased approach that will see a significant increase in the quality and variety of available radioactive beams, and a tripling of the user beam time by 2031. This will allow a large number of high priority measurements to more quickly move ahead.

To fully leverage these opportunities, Government of Canada support for TRIUMF to allow for *operational support necessary to fully exploit the science opportunities of ARIEL (9000 hours of RIB per year) is essential*. Strategic investments by NSERC in the additional HQP needed to run the experiments, analyze the data, and disseminate the results in a timely fashion is also critical to maximize the scientific output.

Recommendation 5: Position Canada for leadership in future international nuclear physics research

The Canadian nuclear physics program is grouped around several key questions that are internationally recognized as being of high priority. To advance our understanding of these key questions, it is understood that Canadians must be leading participants in the development of major international projects. These potential future flagship endeavors should receive the strategic investments needed to position Canada for key leadership roles.

Significant international nuclear physics projects with significant Canadian leadership contributions include Qweak and GlueX at Jefferson Lab and ALPHA at CERN. The Electron-Ion Collider (EIC) is a major international facility on the future horizon, which will uniquely address profound questions about nucleons (neutrons and protons) and how they are assembled to form the nuclei of atoms. Canadians have been involved in the planning of the EIC program for some time, and a Canadian was recently elected as International Representative on the EIC User's Group Steering Committee. *A substantial involvement in the EIC project will confirm Canada's leadership role in scientific research and development.*

Recommendation 6: Grow the nuclear physics research community

The 15 years of the coming long range plan constitute a very substantial fraction of the career of most researchers. Over this plan, therefore, there will be a large renewal of the senior researcher ranks of our field. Substantial scientific opportunities in both theory and experiment, such as

ARIEL and EIC listed above, but also at new international radioactive beam facilities like FRIB and FAIR, make the case for an expansion of investment in nuclear physics research at universities across Canada.

Historically, bridge faculty positions have proven to be an effective way to strategically grow research capacity in highly promising fields within Canadian universities. Successful nuclear physics faculty bridge programs that have been used in Canada and abroad include: TRIUMF, RIKEN-BNL Research Center (open to Canadian institutions), FRIB Theory Alliance, and Jefferson Lab.

We encourage our community to seek innovative sources of funds for such positions, from national or international laboratories, provincial institutes, or foundations, so that the substantial scientific opportunities we see in the next 15 years can be best taken advantage of. Because of the NSERC grant eligibility rule, such matching funds must be sought from outside the SAP envelope.

The TRIUMF bridge program has a long history of success, playing a vital role in the renewal and growth of the Canadian nuclear physics research community. We also support TRIUMF in seeking the funds to strengthen its bridge faculty program for the future.

Recommendation 7: Foster a funding environment which enables Canadian researchers to lead in science and discovery

Canadian researchers are at the forefront of subatomic physics research. To maintain this high level of performance in the years to come, it is essential for the range of funding opportunities and resources already in place be strengthened and expanded.

- (a) Sufficient and versatile funding opportunities for both capital equipment and operational funding are essential to position Canadian researchers to react quickly to new research opportunities as they arise, but also the stability for planning with the long-term perspective necessary for major initiatives. The interplay between NSERC, CFI and the new computing agency (4.4) needs to be strengthened, so that capital, operating fund and high performance computing resource decisions are coordinated and streamlined.
 - To improve the effectiveness of CFI funding programs, we recommend the federal government provide CFI with a stable, annual budget, that CFI start yearly IF competitions, and that CFI significantly reduce the IF evaluation overhead, removing stages and review instances. CFI institutional envelope restrictions often translate to a funding level gap, since the IF program has a lower cut-off for funds. Furthermore, the CFI-JELF program is of limited effectiveness, since it is typically directed to junior and senior career researchers at universities, leading to a gap in support for mid-career investigators.
 - NSERC-RTI support for small scale detector developments is important for quick term small scale upgrades and/or perform proof of principle tests towards undertaking a new major development. Unfortunately, the RTI success rate has been very low and its proportion of the SAP envelope is well below historic levels. *It is essential to restore the flexibility of the SAP envelope, so that RTI-1 projects at the \sim \$200k scale can be funded with a reasonable success rate. We see this as a strong rationale for an infusion of new funds to the envelope.*

Table 6.2 lists the major experimental initiatives that will require significant capital funding if the promised substantial improvements over current knowledge are to be realized. The largest projects on the \sim 2025–2030 planning horizon include:

- nEXO at SNOLAB.
- ISAC heavy ion storage ring with a neutron generator target.
- Radioactive Molecules (RAMS) for fundamental physics facility at ISAC/ARIEL.
- Canadian contributions to detectors at the Electron-Ion Collider.

Opportunities may also arise at the next-generation in-flight facilities FRIB (USA) and FAIR (Germany), which will provide first beams during the period covered by this long range plan.

In summary, the future progress of experimental knowledge depends on continuing investments in new experimental techniques and apparatus. In many cases, these investments have the further benefit of enabling technology-transfer to Canadian industry.

- (b) NSERC and TRIUMF should continue to provide technical resources and capabilities for supporting the construction of experiments, through their MRS program and the TRIUMF Science & Technology department.

TRIUMF is a unique resource that allows Canadians to lead in nuclear physics programs worldwide. It plays a major role as a national infrastructure support base to the Canadian offshore nuclear physics program, and its' international reputation in the quality of technical support provided is extremely high. For many years, these supports have included detector construction, electronics, DAQ, and cryogenics, and they are vital, for example, to CFI-funded projects destined offshore, such as ALPHA-g at CERN and Qweak at JLab. Whenever possible, TRIUMF should attempt to provide subsidized-cost technical manpower.

The NSERC MRS-funded facilities at selected universities provide valuable technical supports that are available for use by all SAP researchers nationwide, irrespective of the location of the MRS-funded facility. The MRS program supports the retention of technical expertise at universities, and plays a complementary role to TRIUMF's Science and Technology department, whose resources are highly constrained.

- (c) Ongoing investments in detector and accelerator R&D are needed to assure the continued excellence of Canadian nuclear physics research in coming decades, and to continue the positive impacts that fundamental research has had on Canadian society and industry. Such funds are particularly needed as a seed for future projects and to explore improved technologies, including machine learning algorithm, quantum sensing and information technologies. Several areas of projected benefit include:

- Accelerator R&D in support of ARIEL targets for RIB production (materials, ion sources, etc.).
- Precision manufacturing capabilities and cutting edge expertise in mechanical and electronics engineering, and data acquisition system (real-time computing) for gas detector and thin silicon detector technology for nuclear physics experiments.
- Precision techniques needed to address fundamental physics questions. Canada has traditionally strong expertise in low-energy precision measurements, and additional investments in this area could allow it to play a leading role.

6.2 Budget estimates to implement recommendations

The Canadian Subatomic Physics Long Range Plan Terms of Reference includes a requirement that “budgetary estimates, both for new capital investments as well as for operations, must be provided as well, including funding ranges for prioritized endeavours. These ranges should include funding levels that would allow for a restrained, yet efficient, contribution to the ventures, as well as levels that would enable a more extensive contribution.” To provide the nuclear physics research community input to this eventual recommendation, the CINP requested budgetary information from the nuclear physics community under the two scenarios listed above. These funds include resources needed from NSERC, CFI, other Canadian agencies, and international partners.

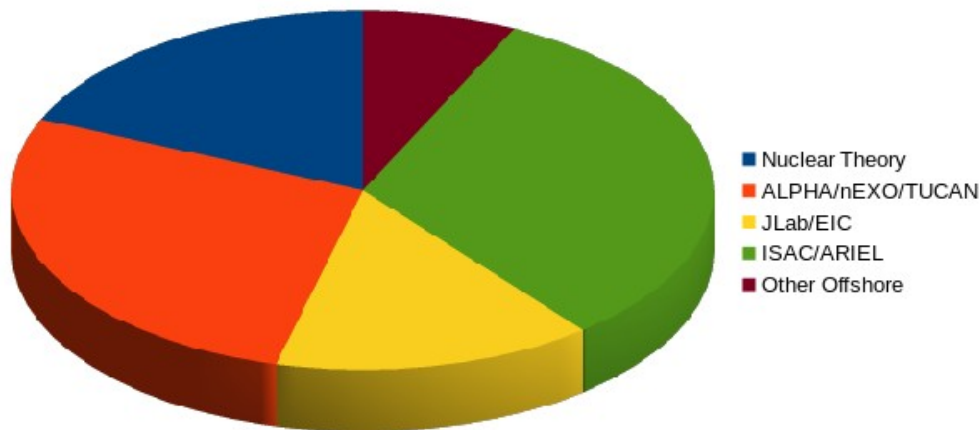

Figure 6.1: Division of grant-eligible investigator full-time-equivalent (FTE) research effort, collated from the submitted briefs to CINP as part of our consultation process. Please note that investigator efforts from the TRIUMF Accelerator and Science & Technology groups are not included.

The community response was very good. Principal Investigators from 33 projects, representing 75 FTE faculty members from 19 universities and TRIUMF, submitted briefs, which included investigator full-time-equivalent (FTE) research effort (Fig. 6.1), and projected NSERC operating and capital budgetary needs which were used to arrive at the estimates presented in Tables 6.1, 6.2.

6.2.1 Restrained (minimum viable) scenario

The minimum viable program is estimated at \$8.82 million operating per year (theory and experiment) and does not address recommendations 1 and 3. *In most cases, this corresponds to what the research groups receive now.* In this restrained funding scenario, the Canadian nuclear physics community could ultimately find itself unable to capitalize on the new scientific opportunities and the major capital investments which have been made in world-class experimental equipment both domestically and abroad. Full exploitation of these new scientific opportunities requires a corresponding increase in the NSERC subatomic physics envelope to support the research teams that drive the scientific output from these major capital investments.

All figures for 2022–2027	Investigator FTE	Restrained (minimum viable) (\$k/yr)	Optimal (more extensive) (\$k/yr)	Difference (optimal vs. restrained) (%)
Nuclear Theory	14.0	672	1109	65
ALPHA-3/g	7.4	1015	1400	38
nEXO	7.5	912	1100	21
TUCAN	6.0	550	900	64
JLab-Hadrons	3.7	306	395	29
JLab-MOLLER	4.0	400	520	30
EIC	1.3→ 4.2	143→ 546	165→ 655	20
ISAC/ARIEL Experiment	24.3	3750	5597	49
Neutron beam+CREX	1.8→ 0.9	205	255	24
RIB Offshore	4.5	657	890	35
Experiment Total	60.9	8145	11467	41

Table 6.1: Projected NSERC operating costs per year and investigator FTE for 2022–2027. Arrows indicate a ramp-up or ramp-down of expected effort during the 5 year period. Please note that we have not independently vetted any of these numbers, they are given to us as a result of community consultations. The sum may not add exactly to the total of the individual items due to time-averaging and rounding.

6.2.2 The optimal scenario

Based on the input received from the community, operating investments estimated at \$12.5 million operating per year are needed to fully capitalize on the available scientific opportunities. These figures represent a 5 year snapshot of projected needs (2022-2027), and where possible the expected ramp-up or ramp-down of activities is indicated by arrows.

The first line in Table 6.1 shows the requested increases in nuclear theory support, summed over the input received from 7 theory briefs representing 14 FTE researchers. In the restrained scenario, nuclear theory operating grants are only 7.6% of the nuclear physics total, well under the 15% of funds threshold recommended in the 2017–21 Long Range Plan to maintain a vibrant theoretical physics effort. Implementation of Recommendation 1 (optimal scenario) will enable improved postdoc and graduate support for Canadian nuclear theory researchers, and improve the collaboration between nuclear theory and experiment. Table 6.1 indicates a 65% increase for Canadian nuclear theory researchers and represents a modest increase in funding of only about \$440k over five years. Clearly, a modest infusion of new funds would pay significant dividends, and this investment is clearly justified by the world-class talent that Canada has recently recruited from abroad. If Canada is able to recruit additional top talent, then this number would increase accordingly.

The remainder of Table 6.1 is dedicated to experimental work. Several projects are ramping-up their activities, including EIC and the RAMS project at ISAC/ARIEL, and hence have larger increases. The other experimental operations request increases of 33% over the next 5 years, primarily for an increase in students and postdocs needed for full scientific exploitation of the newly operational equipment and substantive increases in available beamtime expected over the next planning period. Including the new projects ramping up, we estimate the cost of recommendation 3 to be

about \$3.3 million over five years, corresponding to an increase of 7.1% per annum. This infusion of funds will ensure continuing Canadian leadership in these fields.

6.2.3 Major capital investments

	CFI Capital (Total \$k)	Other Canadian (\$ k)	International Contribu- tion (\$k)
Nuclear Theory Computation (Guelph)	482		
<u>Canada-non-ISAC</u>			
ALPHA (HAICU CFI submitted Jan 2020)	4559	6839	
nEXO (CFI application submitted Jan 2020)	6500	6500	3600
nEXO (anticipated CFI in 2023, 2025)	20000	20000	240000
TUCAN He liquefier upgrade (~2024)	1500	2500	
<u>ISAC/ARIEL Upgrades</u>			
BeEST (starting 2021)		100	4500
Fr EDM (ramp up starting 2021)	300		
IRIS TPC (anticipated CFI 2023)	768	1152	
Total Absorption Spectrometer (~2024)	1000	1500	
Neutron Pseudo-Bar Array (~2025)	800	2000	
Radioactive Molecules RAMS (2021 → 2027)	5000		5000
TITAN Upgrades (2021)	700	130	
<u>Offshore</u>			
ALPHA (HAICU @ CERN ~2025)	5000	5000	2000
EIC (application ~2024)	1500–6000		
JLab-MOLLER (CFI submitted 2020)	6000	120	
JLab-SoLID (construction 2023–2025)			1000
<u>TRIUMF Storage Ring</u>			
NFRF (Exploration 2023–2024)		200	
NFRF (Transformation 2025–2026)		6000	
Construction (2026–2029)	35000	tbd.	tbd.
CFI-IOF (2030+)		2100	
Capital Total	95709	51941	256100

Table 6.2: Projected capital needs for the coming decade. Please note that we have not independently vetted any of these numbers, they are given to us as a result of community consultations. ‘Other Canadian’ typically refers to provincial or NSERC-RTI funds. ‘International Contributions’ indicate the value of in-kind contributions or cash by foreign partners to Canada.

Table 6.2 lists the projected capital needs of the Canadian nuclear physics community for the next decade, including CFI-IF expected requests, other Canadian (typically provincial or NSERC-RTI) and international partner contributions. The success of these projects depends strongly on the acceptance of Recommendation 7, which is needed to position Canada well in terms of international scientific leadership in the coming decade.

In the near term, the largest new projects will be nEXO, MOLLER and HAICU, each of

which have submitted funding requests in the current CFI-IF competition, and the Radioactive Molecules for Fundamental Physics (RAMS) project proposed for ISAC/ARIEL. Smaller near term projects include BeEST, Fr EDM, and the TITAN Upgrade at ISAC. For those projects with CFI applications currently under review, we anticipate they would re-apply in the next CFI-IF competition if funds are not awarded in 2020, leading to unchanged total capital needs through 2027.

By the middle of the decade, substantial requests are projected to come for a new Total Absorption Spectrometer for use in γ -ray spectroscopy, a Neutron Pseudo-Bar Array, the IRIS TPC at ISAC, the TUCAN liquefier upgrade, and Canadian contributions to EIC detectors, with a smaller request for SoLID. And a large project, accounting for roughly $\frac{1}{3}$ of the total projected capital needs for the next decade, would be the TRIUMF Storage Ring described in Sec. 4.1.1.5.

Some details on the near and medium-term projects with projected cost \gtrsim \$2M:

- In 2019, the DOE announced CD-0 (Mission Need) for a tonne-scale $0\nu\beta\beta$ experiment, which will likely have a total cost of about US\$240M. It is widely anticipated that this experiment would be located at SNOLAB, and assuming nEXO will be selected by DOE in the next year, construction would take place 2022–2027, with data taking to start shortly thereafter. During the construction phase of nEXO, nEXO Canada expects to request additional support from CFI in the 2023 and 2025 IF competitions, as listed in Table 6.2.
- MOLLER has received CD-1 (Design, Schedule and Cost Range) from DOE, and will be additionally funded through a US\$6M NSF mid-scale grant and a \$6M CFI IF proposal that was submitted for the ongoing 2020 competition. The CFI proposal requests funding to contribute the main detector array and electronics. The overall capital cost of MOLLER is about US\$40M. The Canadian group plans to complete design and prototype testing within the next year, proceed to construction by 2022, and begin commissioning and data taking sometime shortly after 2025. MOLLER data taking would take place 2025–2030, depending on the flow of funds, and the completion of construction and commissioning.
- In the next decade, HAICU will enable an ambitious series of developments of quantum sensing techniques to dramatically improve the precision of antihydrogen-hydrogen symmetry tests. A CFI-IF proposal has been submitted for the initial phase of development, which will take place in Canada and use atomic hydrogen as a proxy for antihydrogen. In future phases (beyond 2025), the new techniques are expected to be deployed to CERN, and ALPHA-Canada expects to request additional support from CFI, as listed in Table 6.2.
- The proposed RAMS program is extensive: 1) Permanent electric dipole moments (EDMs) in molecules, sensitive to the electron’s EDM; 2) Parity violation in molecules, sensitive to the weak interaction between electrons and quarks, and $N - N$ weak interactions ; 3) P, T violating nuclear Schiff moments. Experimental setups of the initial proposed program are currently in development in the USA (MIT, CalTech), UK (Edinburgh) and TRIUMF and are planned to be ready by 2022. The search for EDMs is expected to start in 2025 and continue with gradually improved precision for 3 to 5 years.
- The Gamma-Ray collaboration is currently investigating the development of a next-generation Total Absorption Spectrometer (TAS), optimized for studies of extremely neutron-rich nuclei at ISAC/ARIEL. The ISAC-TAS would be designed specifically with the goal of studying

the β decays of the extremely neutron-rich nuclei to be provided by the ARIEL photofission driver, and be complementary to the high-resolution TIGRESS and GRIFFIN spectrometers based on High-Purity Germanium (HPGe) detectors. The total capital cost of the ISAC-TAS, including crystals, PMT's/SIPMs, tape station, implantation detector and digital electronics is estimated to be approximately \$2.5M, with the plan being to request these funds over the 2024–2026 period, with the facility in operation at TRIUMF by late 2026/early 2027.

- The envisioned pseudo-bar neutron detector will be constructed of p-terphenyl using a similar concept to TexNEUT. The applications of the array will be complementary to existing neutron detectors such as DESCANT, and targeted towards time-of-flight neutron spectroscopy with high resolution, high granularity, and n/γ pulse shape discrimination. The array is expected to be sensitive to neutrons with energies of a few hundred keV up to ~ 10 MeV. In addition to transfer reactions, the array will also be suitable for in-flight neutron decay spectroscopy, β -delayed neutron spectroscopy, and direct measurements of astrophysical (α, n) or (p, n) reactions.
- The IRIS TPC project will advance the scope of reactions with rare isotopes, complementing the capabilities with existing active targets at other laboratories. Its advantageous feature (particularly for improved gas amplification) using thick GEMs and MICRO-Mesh-Gaseous Structure (Micromegas) will allow use of pure H₂ and D₂ gases, enabling measurements with low background. The physics program will complement the TIGRESS+EMMA program by extending the reach to more exotic nuclei and the neutron unbound states than possible by γ -ray detection.
- During the EDM run anticipated to begin 2023, the TUCAN Collaboration expects to reach the limits of the TRIUMF Meson Hall helium liquefier, and is considering an upgraded liquefier facility, which could be requested from CFI and other sources.
- For the next 5 years, the Canadian EIC development activities will focus on simulation and computing infrastructure, polarimetry, and calorimetry. By 2026, EIC Canada anticipates the acceptance of their Expression of Interest in international detector development efforts (submitted in late 2020), and to be at the start of the construction phase of a major Canadian detector component of between \$1.5–6M. Installation, data taking, and initial physics are expected to begin near the end of the decade.

Regarding the ambitious TRIUMF Storage Ring Project:

- The next 5 years will be used to seek funding for a machine study via a 3-year NSERC Project Grant (to be submitted in 2021) and potentially an NFRF (New Frontiers in Research Fund). If the project grant receives funding, the project could start in April 2022. In this case, 2022 would be the start of beam dynamic calculations, followed by the definition of a Physics program (White paper); Design of cavities, electron cooler, gas target, neutron generator, RF cavity design, magnet design, power supplies specifications, vacuum system layout, electron cooler specifications, and beam diagnostics design.
- By 2024–25, the Technical Design Report (TDR) is expected to be finished, including budget; CFI Project Preselection phase at partner university; Submission of Letter of Intent, and Submission of CFI grant for storage ring and neutron generator (project cost C\$30–40 million). If CFI funding is successful, the start of the construction would be in 2026, with the first

commissioning of the storage ring with beam expected within 3 years (in 2029/30). Taking at least 1 year for full commissioning, the facility could be fully operational for first physics (Day-0) experiments in 2031. With an external ion source, the neutron generator could be installed and tested with part of the beamlines earlier, potentially by 2028.

- For the operating costs after finalization of the construction, CFI-IOF funds would be sought. For a project size of C\$35 million, this would mean a request of C\$10.5 million over 5 years, from 2030–34. The additional staff from TRIUMF Accelerator Division required for the long-term operation of the new facility as well as other operational requirements would require a substantial increase of the NRC contributions to TRIUMF from 2026 on (i.e. in the next TRIUMF 5-Year-Plan, 2025-30 and following).

Appendix A

List of Acronyms

ACTAR TPC: Active Target and Time Projection Chamber

AD (Antiproton Decelerator): An antiproton facility at CERN, currently the only in the world which provides high quality antiproton beams.

AGB star (Asymptotic Giant Branch): Region in the Hertzsprung-Russell diagram. Intermediate-mass stars with 0.6–10 solar masses leave the Main sequence after completion of their hydrogen burning phase and appear as Red Giant star in the Asymptotic Giant Branch region when they ignite helium burning and thus increase their luminosity.

ALPHA (Antihydrogen Laser PHysics Apparatus): An experimental program at the CERN Antiproton Decelerator which performs antihydrogen symmetry tests.

ALPHA-2/3: The second generation apparatus and subsequent upgrade of the ALPHA experiment focused primarily on precision laser spectroscopy.

ALPHA-g: An experimental apparatus to measure the gravitational interaction of antihydrogen, which is mostly Canadian funded.

ANL (Argonne National Laboratory): A DOE national laboratory in Argonne, Illinois, which is home to a number of facilities, including the ATLAS heavy-ion accelerator.

APS (American Physical Society)

ARC (Astronomy Research Center): Communication platform to increase awareness and opportunities in astronomical research at the University of Victoria. ARC hosts an NSERC-CREATE training program on New Technologies for Canadian observatories

ARIEL (Advanced Rare Isotope Laboratory): A project to enhance TRIUMF's capabilities to produce rare isotope beams and to showcase new Canadian accelerator technology.

ARIES (Ancillary detector for Rare-Isotope Event Selection): Ancillary detector subsystem of the GRIFFIN spectrometer for beta tagging and fast-timing.

BELEN (Beta-deEayEd Neutron detector) European ^3He -long counter neutron detection array built for operation within the DESPEC collaboration at FAIR. It can be used at both, ISOL and in-flight fragmentation facilities.

BNL (Brookhaven National Laboratory): A DOE national laboratory in Upton, New York, which is home to a number of facilities including RHIC and the future EIC.

BRIKEN (Beta-delayed neutron studies at RIKEN) Large ^3He -long counter neutron detection array with an implantation detector which will take data at RIKEN Nishina Center until 2021.

CANREB (CANadian Rare-isotope facility with Electron-Beam ion source): A CFI-funded initiative that will improve the purity of rare ion beams delivered by ARIEL to ISAC.

CANS (Compact Accelerator-driven Neutron Source): A less expensive, alternative technology to nuclear reactors based on an accelerator-driven neutron source.

CARIBU (CALifornium Rare Isotope Breeder Upgrade): A facility for creating neutron-rich rare isotopes at Argonne National Laboratory.

CEMP (Carbon-Enhanced Metal-Poor): A set of stars with very low abundances of heavy elements whose origin cannot be described by the two main heavy element production processes, the rapid and the slow neutron capture process.

CERN (Centre European pour la Recherche Nucleaire): The European Organization for Nuclear Research, based in Geneva, Switzerland.

CFI (Canada Foundation for Innovation): Created by the Government of Canada in 1997, CFI makes investments in state-of-the-art research facilities and equipment in a wide variety of scientific disciplines.

CINP (Canadian Institute of Nuclear Physics): The organization that gathered input from the Canadian nuclear physics research community in order to put together this document.

CNO cycle: Hydrogen burning cycle in the interior of stars involving isotopes of carbon (C), nitrogen (N), and oxygen (O).

CPT (Canadian Penning Trap): The CPT spectrometer is designed to provide high-precision mass measurements of short-lived isotopes. It is located at the Argonne National Laboratory in Argonne, Illinois.

CPT (Charge, Parity, Time reversal): A fundamental property of local relativistic quantum field theories.

CR (Collector Ring): Large storage ring presently being constructed as part of the new FAIR facility in Germany.

CREX (Calcium Radius EXperiment): Measurement for the measurement of the neutron-skin in ^{48}Ca at Jefferson Laboratory.

DCSB (Dynamical Chiral Symmetry Breaking): The mechanism by which quark-gluon interactions are expected to dynamically generate most nucleon mass, ultimately accounting for $> 98\%$ of the mass of the visible universe.

DESCANT (DEuterated SCintillator Array for Neutron Tagging): A neutron detector array to be used at ISAC.

DESPEC (DEcay SPECTroscopy): Decay spectroscopy collaboration at FAIR.

DFT (Density Functional Theory)

DOE (Department of Energy): The United States Department of Energy, which operates a number of national laboratories across the USA.

DRAGON (Detector of Recoils And Gammas Of Nuclear reactions): A detector designed to measure the rates of nuclear reactions important in astrophysics, based at ISAC-I.

DSAM - Doppler Shift Attenuation Measurements; a technique to measure femto-second lifetimes of nuclear levels.

EBIT/S (Electron Beam Ion Trap/ Source)

EDM (Electric Dipole Moment): Permanent electric dipole moments are forbidden for fundamental particles by time reversal violation.

EFT: Effective Field Theory

EIC (Electron-Ion Collider): A new DOE nuclear physics user facility to be constructed at Brookhaven National Laboratory.

ELENA (Extra Low ENergy Antiproton ring): Antiproton cooling and deceleration ring, under construction as an upgrade to the Antiproton Decelerator at CERN.

EMMA (ElectroMagnetic Mass Analyzer): A device being constructed to study the products of nuclear reactions involving rare isotopes at ISAC-II.

EOS (Equation of State): Thermodynamic equation relating variables which describe the state of matter under a given set of physical conditions, in astrophysics for example for the relation between the pressure and the density, and the resulting radius of neutron stars.

ESR (Experimental Storage Ring): Heavy-ion storage ring at the GSI Helmholtz Center for Heavy Ion Research in Germany.

EXACT-TPC: Exotic Nuclei Active Target Time Projection Chamber

EXO (Enriched Xenon Observatory): An experiment seeking to measure neutrinoless double beta-decay in ^{136}Xe . The experiment is currently located at the WIPP facility in New Mexico, USA. A substantially larger next-generation detector nEXO is proposed for SNOLAB.

FAIR (Facility for Antiproton and Ion Research): An accelerator facility for studying nuclear structure and nuclear matter, presently under construction as upgrade of the GSI facility in Darmstadt/ Germany.

FCAL: Forward Calorimeter

FIPPS (FISSION Product Prompt γ -ray Spectrometer) is a γ -ray spectrometer used at ILL Grenoble.

FRIB (Facility for Rare Isotope Beams): A new DOE user facility for nuclear science, under construction on the campus of Michigan State University.

FrPNC (Francium Parity Non-Conservation): An experiment to study atomic parity non-conservation in francium, based at ISAC-I.

GANIL (Grand Accélérateur National d'Ions Lourds): France's national heavy-ion facility specializing in the production of a wide variety of intense stable and rare-isotope beams for nuclear physics research and applied nuclear science.

GlueX (Gluonic Excitations Experiment): An experiment seeking to identify hybrid mesons with explicit gluonic degrees of freedom at Jefferson Lab Hall D.

GPD (Generalized Parton Distribution): A framework to better understand hadron structure by representing the parton distributions as functions of more variables, such as transverse momentum and parton spin. They can be used to study the spin structure of the proton, and will enable a tomographic 3D picture of the proton to be built up.

GRIFFIN (Gamma-Ray Infrastructure For Fundamental Investigations of Nuclei): Compton-suppressed High-purity germanium clover array for gamma-ray spectroscopy with stopped radioactive ion beams.

GW170817 (Gravitational Wave): Gravitational wave signal detected by LIGO and Virgo on August 17th, 2017. This event was triggered by a binary neutron star merger and the following light curve of the electromagnetic signature, a kilonova, showed for the first time signatures of heavy element production in the rapid neutron-capture process.

GSI: Formerly "Gesellschaft fuer Schwerionenforschung", now GSI Helmholtz Center for Heavy Ion Research in Darmstadt, Germany.

HAICU (Hydrogen-Antihydrogen Infrastructure at Canadian Universities for quantum innovations in antimatter science): A proposed CFI initiative to establish an infrastructure in Canada for the development of quantum sensing techniques for antimatter research, such as anti-atomic fountains and antimatter wave interferometers.

HERA: A former electron proton collider at the DESY laboratory in Hamburg, Germany.

HGC (Heavy Gas Cherenkov detector): A Cherenkov detector that makes use of a gas with high index of refraction (typically a form of Freon) for particle identification in subatomic physics experiments.

HIE-ISOLDE (High Intensity and Energy ISOLDE) - an upgrade of the current ISOLDE facility at CERN to produce accelerated radioactive beams.

HPC (High-Performance Computing): Leveraging large scale computing facilities or networks towards problems on scales that are prohibitive on individual systems.

HQP (Highly Qualified Personnel): Personnel obtaining advanced skills as a result of NSERC-funded research, including students, postdocs and technicians.

IAEA (International Atomic Energy Agency): Set up within the United Nations family in 1957 as the world's centre for cooperation in the nuclear field, the Agency works with its Member States and multiple partners worldwide to promote the safe, secure and peaceful use of nuclear technologies.

IBM: The interacting boson model (IBM) is a model used in nuclear physics calculations.

IG-LIS (Ion Guide Laser Ion Source): Laser ion source that can be operated at TRIUMF-ISAC. Provides excellent suppression of unwanted surface-ionized species by a repeller electrode.

IHEP: The Institute for High Energy Physics, in Beijing, China.

ILIMA (Isomers, Lifetimes, and Masses): Collaboration for the measurement of lifetimes and masses of radioactive isotopes in storage rings like the ESR at GSI and the new CR at FAIR in Germany.

ILL: The Institut Laue–Langevin is an internationally scientific facility, situated on the Polygone Scientifique in Grenoble, France. It is one of the world centres for research using neutrons.

INCITE: Novel Computational Impact on Theory and Experiment, US Department of Energy program.

IReNA (International Research Network for Nuclear Astrophysics): US National Science Foundation AccelNet Network of Networks connecting six interdisciplinary research networks across 17 countries to foster collaborations in Nuclear Astrophysics.

ISAC (Isotope Separator and ACcelerator): A rare isotope accelerator facility, based at TRIUMF. There are two experimental halls, ISAC-I and ISAC-II.

ISOL (Isotope Separation On-Line): A technique of radioactive ion production in which spallation and fission of thick targets is used to produce a wide range of radioactive nuclei.

ISOLDE (Isotope Separator On-Line DEtector): An On-Line Isotope Mass Separator facility at CERN for the study of low-energy beams of radioactive isotopes .

JLab (Jefferson Lab): The Thomas Jefferson National Accelerator Facility, located in Newport News, Virginia.

JEF: Jefferson Lab Eta Factory, at Hall D, Jefferson Lab.

JELF (John R. Evans Leaders Fund): A CFI program that enables a select number of an institution's researchers to undertake research by providing them with the infrastructure required to be or become leaders in their field.

JINA-CEE (Joint Institute for Nuclear Astrophysics - Center for the Evolution of the Elements): Multi-institutional Physics Frontiers Center funded by the US National Science Foundation.

J-PARC (Japan Proton Accelerator Research Complex): A high intensity proton accelerator facility located in Kamioka, Japan.

LGC (Light Gas Cherenkov detector): A Cherenkov detector that makes use of a gas with low index of refraction (typically a noble gas such as Neon) for particle identification in subatomic

physics experiments.

LIGO (Laser Interferometer Gravitational-wave Observatory): NSF-funded gravitational wave observatory to detect cosmic gravitational waves and to develop gravitational-wave observations as an astronomical tool. The two LIGO interferometers are located in the USA in Hanford, Washington and Livingston, Louisiana.

LLNL: Lawrence Livermore National Laboratory, located in Livermore, California.

LQCD: Lattice QCD.

MAMI (Mainz Microtron): An electron accelerator facility, located on the campus of the Johannes Gutenberg University of Mainz, Germany.

Majorana: An experiment whose objective is to study double beta-decay in ^{76}Ge .

MCMC (Markov-Chain Monte Carlo): In statistics, MCMC methods comprise a class of algorithms for probability distribution.

MESA (Mainz Energy-Recovering Superconducting Accelerator): A new electron synchrotron under construction on the campus of the Johannes Gutenberg University of Mainz, Germany.

MINIBALL - a gamma-ray detector array based at ISOLDE-CERN.

MOLLER: An experiment to measure the parity-violating asymmetry in electron-electron (Moller) scattering at Jefferson Lab.

MR-TOF (Multi-Reflection Time-of-Flight): A MR-TOF traps ions between two electrostatic mirrors, folding the flight path into an extremely compact device, while achieving resolving powers on the order of 10^5 .

NASA: National Aeronautics and Space Administration, founded in 1958, is an independent agency of the U.S. federal government responsible for the civilian space program, as well as aeronautics and space research.

NCSM: No-Core Shell Model

NCSMC: No-Core Shell Model with Continuum

NERSC (The National Energy Research Scientific Computing Center): The primary scientific computing facility for the Office of Science, US Department of Energy. It is located at Lawrence Berkeley National Laboratory, in California.

NLO/NNLO (Next to Leading Order/Next-to-Next to Leading Order): increasing level of complexity of various types of loop diagrams.

NSAC (Nuclear Science Advisory Committee): An advisory committee that provides official advice on basic nuclear science research to the U.S. Department of Energy (DOE) and the U.S. National Science Foundation (NSF).

NSCL (National Superconducting Laboratory): Radioactive beam facility at Michigan State University. Now hosting FRIB.

NEEC/NEET (Nuclear Excitation by Electron Capture/ Nuclear Excitation by Electron Transition): Two nuclear excitation mechanisms in highly-charged ions involving atomic electrons.

NSERC (Natural Sciences and Engineering Research Council of Canada): An agency of the Government of Canada that supports university students in their advanced studies, promotes and supports discovery research, and fosters innovation by encouraging Canadian companies to participate and invest in postsecondary research projects.

NSERC-CREATE: The NSERC Collaborative Research and Training Experience (CREATE) program supports the training and mentoring of teams of highly qualified students and postdoctoral fellows from Canada and abroad through the development of innovative training programs.

NSF: U.S. National Science Foundation.

NuPECC (Nuclear Physics European Collaboration Committee): Co-ordinates nuclear physics research planning as an Expert Committee of the European Science Foundation.

ORNL: Oak Ridge National Laboratory, located in Oak Ridge, Tennessee.

PACES (Pentagonal Array of Conversion Electron Spectrometers): Ancillary detector subsystem of the GRIFFIN spectrometer for internal conversion electron spectroscopy.

PI-ICR (Phase-Imaging Ion-Cyclotron-Resonance): Technique used in ion trap facilities to increase the mass resolution.

POLARIS Polarized Radioactive Isotope Science; a future facility that will produce polarized radioactive beams at TRIUMF

pQCD (Perturbative QCD): QCD in the hard-scattering regime, where perturbative methods can be reliably employed, as opposed to the non-perturbative regime where they cannot.

PREX/CREX (Lead (Pb) Radius Experiment/ Calcium Radius Experiment): Two experiments at Jefferson Lab utilizing parity violating electron scattering to determine the neutron radius of these nuclei, as opposed to their charge or matter radii.

PVES: Parity Violating Electron Scattering.

PWA: Partial Wave Analysis. PWA is a technique for solving scattering problems by decomposing each wave into its constituent angular momentum components and carrying out a spin-amplitude analysis, that includes production and decay elements.

QCD (Quantum ChromoDynamics): The theory describing the fundamental interactions between quarks and gluons.

RAMS (Radioactive Molecules for Fundamental Science): A facility to search for symmetry-violating effects in radioactive molecules proposed for ISAC/ARIEL, and discussed in Sec. 3.4.2.1

RCMP (Regina Cube for Multiple Particles): Ancillary detector subsystem of the GRIFFIN spectrometer for charged-particle spectroscopy.

RCNP (Research Centre for Nuclear Physics): A national centre for nuclear physics, based in Osaka, Japan.

RDM - Recoil Distance Method (RDM) for measuring pico-second lifetimes of nuclear levels.

RHIC (Relativistic Heavy-Ion Collider): A high-energy heavy-ion collider facility based at Brookhaven National Laboratory.

RIB: Rare/ radioactive ion beam.

RIBF (Rare Isotope Beam Factory): A user facility for nuclear science, located at RIKEN Nishina Center in Japan.

RIKEN (The Institute of Physical and Chemical Research): Japan's largest comprehensive research institution that performs research in a diverse range of scientific disciplines, including physics, chemistry, medical science, biology and engineering. Founded in 1917 as a private research foundation in Tokyo, RIKEN has grown in size and scope, and now encompasses a network of research centers and institutes across Japan.

SAL (Saskatchewan Accelerator Laboratory): The former electron accelerator at the University of Saskatchewan.

SAP (SubAtomic Physics): The broader field of nuclear and particle physics, comprising all knowledge taking place at scales smaller than that of the atom.

SCEPTAR (SCintillating Electron-Positron Tagging ARray): Ancillary detector subsystem of the GRIFFIN spectrometer for beta tagging.

SHARC (Silicon Highly-segmented Array for Reactions and Coulex): Ancillary detector subsystem of the TIGRESS spectrometer for charged-particle detection.

SiPM: Silicon Photo Multiplier.

SLAC: The Stanford Linear Accelerator Center, in Stanford, California.

SM (Standard Model): The standard model of elementary particle interactions.

SoLID (Solenoidal Large Intensity Device): A high luminosity, large acceptance detector for Jefferson Lab Hall A that makes use of the former CLEO solenoid magnet.

SNO+: An experiment under construction at SNOLAB, whose objective is to use the infrastructure from SNO to study double beta-decay and lower- energy solar neutrinos using a liquid scintillator instead of heavy water.

SNOLAB: An underground science laboratory specializing in neutrino and dark matter physics, based in Sudbury, Canada.

SPICE (SPectrometer for Internal Conversion Electrons): Ancillary detector subsystem of the TIGRESS spectrometer for internal conversion electron spectroscopy.

SPIRAL 2: A heavy-ion accelerator facility in Caen, France.

SRF (Superconducting Radio Frequency): Acceleration of charged particles via the use of superconducting cavities operating in the radio frequency range. Several examples include the ISAC-II and ARIEL accelerators at TRIUMF, and the Continuous Electron Beam Accelerator at Jefferson Lab.

TASCC (Tandem Accelerator Superconducting Cyclotron): The former heavy-ion accelerator at Chalk River.

TIGRESS (TRIUMF-ISAC Gamma-Ray Escape-Suppressed Spectrometer): Compton-suppressed and segmented high-purity germanium clover array for gamma-ray spectroscopy with accelerated stable and radioactive ion beams.

TIP (TIGRESS Integrated Plunger): Ancillary detector subsystem of the TIGRESS spectrometer for heavy-ion recoil detection.

TITAN (TRIUMF's Ion Trap for Atomic and Nuclear science): An ion trap facility at ISAC for high-precision mass measurements of rare isotopes.

TI-STAR (TIGRESS Silicon Tracker ARray): New auxiliary charged particle detector optimized for direct nuclear reaction studies with heavy, exotic beams at ARIEL. It will be coupled to the TIGRESS array.

TPC (Time Projection Chamber): Particle detector that uses a combination of electric fields and magnetic fields together with a sensitive volume of gas or liquid to perform a three-dimensional reconstruction of a particle trajectory or interaction.

TRIFIC (TRIUMF Fast Ionization Chamber): Ancillary detector subsystem of the TIGRESS spectrometer for heavy-ion recoil detection.

TRINAT (TRIUMF Neutral Atom Trap): A device to trap and study the radioactive decays of neutral atoms, based at ISAC-I.

TRISR (TRIUMF Storage Ring): Proposed low-energy, heavy ion storage ring coupled to the ISAC facility at TRIUMF.

TRIUMF (TRI-University Meson Facility): Canada's national laboratory for particle and nuclear physics, based in Vancouver, BC. TRIUMF is owned and operated by a consortium of (presently 21) Canadian universities.

TUDA (TRIUMF U.K. Detector Array): A detector designed to measure the rates of nuclear reactions important in astrophysics, based at ISAC-I.

TUNL (Triangle Universities Nuclear Laboratory): U.S. Dept. of Energy Center of Excellence, consisting of a consortium of Duke University, North Carolina Central University, North Carolina State University, and the University of North Carolina at Chapel Hill.

UCN (Ultra-Cold Neutron): A CFI-funded facility to study neutron properties at high precision in the TRIUMF meson hall.

VS-IMSRG (Valence-Space In-Medium Similarity Renormalization Group): Novel many-body approach which can be thought of as *ab-initio* shell model approach to atoms and nuclei, using electromagnetic and the latest two- and three-nucleon forces.

WEP (Weak Equivalence Principle): A fundamental assumption/property of Einstein's General Theory of Relativity; when applied to antimatter, it requires that the gravitational acceleration of an antimatter body be identical to that of a matter body.

WIMP (Weakly-Interacting Massive Particle)

ZDS (Zero-Degree Scintillator): Ancillary detector subsystem of the GRIFFIN spectrometer for beta tagging and fast coincidence timing.